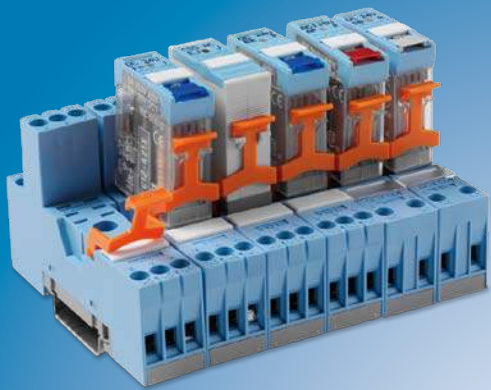


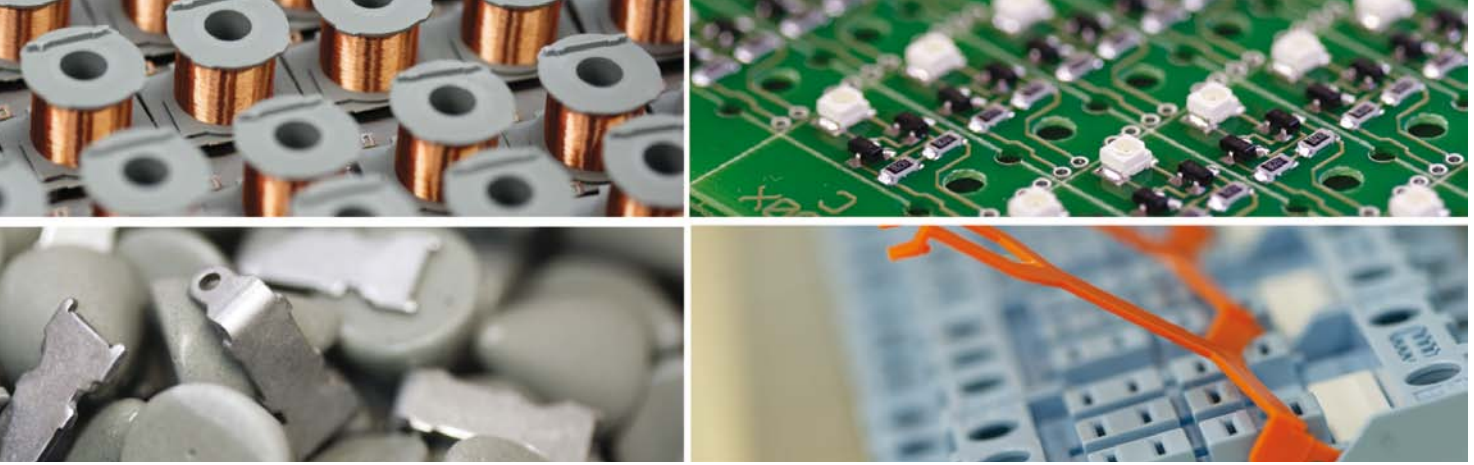


WORLD OF RELAYS

General Catalogue 2012/13

- Industrial-Relays
- Control-Relays
- Installation-Relays
- Time-Relays
- Monitoring-Relays
- Automation-Relays





The Comat/Releco group is the leader in the design and manufacturing of relays. The product range includes all kind of relays for switching, monitoring, timing and automation applications.

Comat AG, based in Switzerland, founded 1970 and Releco SA based in Spain, founded 1962, is a team of more than 200 professionals. The export activities to over 60 countries worldwide represent 80% of the total production. The output is over 5 million relays per year.

Our secret is simply to own the whole process from engineering to manufacturing. This provides us not only a total integration, full control from design, production and marketing, but also flexibility to respond to marked demands, and providing customized solutions for specific applications.

That means:

- R&D
- Coil winding
- Molding and tooling
- Contact mounting
- Metal stamping
- Electrolytic metal treatment
- Plastic injection
- Assembling
- Testing
- Laboratory
- Software
- Quality control
- Application support
- Marketing and sales

We strive to create innovative and best quality products and our international presence in the market is our strength to detect problems and the requirements of the end users.

Comat/Releco: A strong name in the field of relays.

Relays: That is what we know and stand for.

Index Page 2

News in this catalogue Page 5

1. Relays Page 17

1.1 Plug-in Relays				17
1.1.1 Industrial Relays	MRC	C2, C3, R3, C4, C5		25
1.1.2 Miniature Industrial Relays	QRC	C7, R7, C9		51
1.1.3 Interface Relays	IRC	C10, C12		65
1.1.4 Solid State Relays	CSS	CSS-AC, CSS-AZ, CSS-DCN, CSS-DCP		73
1.1.5 Long Life Relays	C20/C30	C21, C22, C31, C32		83
1.1.6 Motor Control Relays		CMC1* , KDM		89
1.2 DIN Relays				93
1.2.1 – Interface Relays	RINT	RINT-11/21, RINT-12/22, RINT-15/25, RINT-18/28		
– Interface Relay Auto-ON-OFF	CHA	CHA1		
– Power Relays		CR16CX, C203.01, B103		
– Signal Relays		CR11C, C203.04, C301.04		
– Control Relay		CR33A		
– Stepping Relay		CRS1C		
– Solid State Relay		KDW		
– Suppressor module for relays		CEM01*		
1.2.2 Power Relays (Contactors)	RIC	RIC20, RIC25, RIC40, RIC63, RIC-AUX		109
1.3 Automation Relays				115
1.3.1 Remote Control Relay	SMS Relay	CMS-10, CMS-20		115
1.3.2 Smart Relay	BoxX	AF10, AF20		123

2. Time Relays Page 129

	Time Functions			130
2.1 Time Cubes	CT	CT2, CT3		133
2.2 Time Modules	CT-System	CT30, CT32, CT33, CT36		137
2.3 Plug-in Time Relays		C83, C84, C85, C63, C64, C55, C56, CS1, CS2, CS3		145
2.4 DIN Time Relays		CIM* , CM, CRV, CSV, AM, CNR, CPF, CY		157

3. Monitoring Relays Page 177

3.1 Plug-in Monitoring Relays				179
– Motor Thermo Protection		TSR19		
– Phase Sequence Monitor		SSU31		
– 3-Phase Monitoring		SSU33L		
3.2 DIN Monitoring Relays				183
– Voltage Monitoring		MRU* , MV53		
– Current Monitoring		MRI* , EOGR, EUOR		
– Multifunction monitoring		MRM*		
– 3-Phase Monitoring		SSU34, SSU36		
– Isolation Monitoring		ESU		
3.3 Monitoring Modules	CT-System	CT512, CT515, CT516, CT524		195

4. Sockets Page 205

For Industrial Relays	MRC	S2, S3, S4, S5
For Miniature Relay	QRC	S7, S9
For Interface Relay	IRC/CSS	S10, S12
Other Sockets	Timer	C12B0

*New products in this catalogue

Relays						1
Type	Page	Type	Page	Type	Page	
4114...	121	C9-E21...	62	RIC40...	112	
4501...	121	C9-E22...	62	RIC63...	113	
AF-10MR-...	128	C9-R21...	63	RINT-11...	95	
AF-10MT-...	128	C10-A10...	66	RINT-12...	95	
AF-20MR-...	128	C10-A15...	66	RINT-15...	96	
AF-20MT-...	128	C10-A18...	66	RINT-18...	97	
AF-MUL/...	128	C10-G10...	67	RINT-21...	95	
App SMSrelay	122	C10-G15...	67	RINT-22...	95	
B103...	103	C10-GT12...	69	RINT-25...	96	
C2-A20...	27	C10-GT13...	69	RINT-28...	97	
C2-A28...	27	C10-T11...	68	RTBSB-001...	122	
C2-A29...	27	C10-T11...	68	WF50 ext-U...	122	
C2-G20...	29	C12-A21...	70	ZPT-10-H...	121	
C2-T21...	28	C12-A22...	70			
C2-T22...	28	C12-G21...	71			
C3-A30...	30	C12-G22...	71			
C3-A38...	30	C21...	84			
C3-A39...	30	C22...	85			
C3-E24...	37	C31...	86			
C3-E28...	37	C32...	87			
C3-G30...	32	C203.01...	104			
C3-M10...	33	C203.04...	105			
C3-N34...	38	C301.04...	106			
C3-N38...	38	CEM01...	108			
C3-R20...	35	CHA1...	98			
C3-R28...	35	CMC1...	90			
C3-R29...	35	CMS-10ACDF...	119			
C3-S14...	36	CMS-10ADF...	119			
C3-S18...	36	CMS-10F...	119			
C3-T31...	31	CMS-GSM-MOD	122			
C3-T32...	31	CR11C...	100			
C3-X10...	34	CR16CX...	99			
C4-A40...	40	CR33A...	101			
C4-A48...	40	CRS1C...	102			
C4-R30...	42	CSS-AC...	74			
C4-R38...	42	CSS-AZ...	75			
C4-R39...	42	CSS-DCN...	76			
C4-X20...	41	CSS-DCP...	77			
C5-A20...	43	DR-15-24...	121			
C5-A30...	44	DR-30-24...	121			
C5-G30...	45	KDM3-24...	91			
C5-M10...	47	KDW3-24...	107			
C5-M20...	48	KS-110...	122			
C5-R20...	49	PS1...	122			
C5-X10...	46	R3-N30...	39			
C7-A10...	52	R3-N34...	39			
C7-A20...	53	R3-N38...	39			
C7-A28...	53	R7-A20...	59			
C7-A29...	53	R7-A24...	59			
C7-G20...	55	R7-A28...	59			
C7-H23...	57	R7-T21...	60			
C7-T21...	54	R7-T22...	60			
C7-T22...	54	RF01-U...	121			
C7-W10...	58	RF01-U-D...	122			
C7-X10...	56	RIC-AUX...	114			
C9-A41...	61	RIC20...	110			
C9-A42...	61	RIC25...	111			

Time Relays 2

Type	Page	Type	Page
AM2...	172	CT32.36...	142
AM3...	173	CT32.37...	142
C55...	151	CT32.38...	143
C55.3...	152	CT32.39...	141
C55.4...	152	CT33...	139
C56...	153	CT33.3-A30...	140
C63...	149	CT33.3-T31...	140
C64...	150	CT33.3-T32...	140
C83...	146	CT33.5-A30...	143
C84...	147	CT33.5-M10...	143
C85...	148	CT33.31...	141
CIM1...	159	CT33.32...	141
CIM2...	162	CT33.33...	141
CIM3...	165	CT33.34...	141
CIM12...	160	CT33.35...	142
CIM13...	161	CT33.36...	142
CIM22...	163	CT33.37...	142
CIM23	164	CT33.38...	143
CIM32...	166	CT33.39...	141
CIM33...	167	CT36...	139
CM3...	168	CT36.3-A30...	140
CNR1...	174	CT36.3-T31...	140
CPF11...	175	CT36.3-T32...	140
CRV2...	169	CT36.5-A30...	143
CRV3...	170	CT36.5-M10...	143
CS1...	154	CT36.31...	141
CS2...	155	CT36.32...	141
CS3...	156	CT36.33...	141
CSV2...	171	CT36.34...	141
CT2-...	135	CT36.35...	142
CT3-...	135	CT36.36...	142
CT30...	139	CT36.37...	142
CT30.3-A30...	140	CT36.38...	143
CT30.3-T31...	140	CT36.39...	141
CT30.3-T32...	140	CY1...	176
CT30.5-A30...	143		
CT30.5-M10...	143		
CT30.31...	141		
CT30.32...	141		
CT30.33...	141		
CT30.34...	141		
CT30.35...	142		
CT30.36...	142		
CT30.37...	142		
CT30.38...	143		
CT30.39...	141		
CT32...	139		
CT32.3-A30...	140		
CT32.3-T31...	140		
CT32.3-T32...	140		
CT32.5-A30...	143		
CT32.5-M10...	143		
CT32.31...	141		
CT32.32...	141		
CT32.33...	141		
CT32.34...	141		
CT32.35...	142		

Monitoring Relays 3

Type	Page	Type	Page
CT512...	198	CT524.37...	201
CT512.3-A30...	200	CT524.38...	203
CT512.3-T31...	200	CT524.39...	201
CT512.3-T32...	200	EOCR...	191
CT512.5-A30...	203	ESU-D2...	194
CT512.5-M10...	203	EUOCR...	191
CT512.31...	201	MRI11...	186
CT512.32...	201	MRI32...	187
CT512.33...	201	MRM11...	188
CT512.34...	201	MRM32...	189
CT512.35...	202	MRU11...	184
CT512.36...	202	MRU32...	185
CT512.37...	202	MV53...	190
CT512.38...	203	SSU31...	181
CT512.39...	201	SSU33L...	182
CT515...	198	SSU34...	192
CT515.3-A30...	200	SSU36...	193
CT515.3-T31...	200	TSR19...	180
CT515.3-T32...	200		
CT515.5-A30...	203		
CT515.5-M10...	203		
CT515.31...	201		
CT515.32...	201		
CT515.33...	201		
CT515.34...	201		
CT515.35...	202		
CT515.36...	202		
CT515.37...	202		
CT515.38...	203		
CT515.39...	201		
CT516...	198		
CT516.3-A30...	200		
CT516.3-T31...	200		
CT516.3-T32...	200		
CT516.5-A30...	203		
CT516.5-M10...	203		
CT516.31...	201		
CT516.32...	201		
CT516.33...	201		
CT516.34...	201		
CT516.35...	202		
CT516.36...	202		
CT516.37...	202		
CT516.38...	203		
CT516.39...	201		
CT524...	199		
CT524.3-A30...	200		
CT524.3-T31...	200		
CT524.3-T32...	200		
CT524.5-A30...	203		
CT524.5-M10...	203		
CT524.31...	201		
CT524.32...	201		
CT524.33...	201		
CT524.34...	201		
CT524.35...	202		
CT524.36...	202		

Sockets 4

Type	Page
C12B0 R	212
S10	224
S10-P	225
S12	226
S12-P	227
S2-B	206
S2-L	207
S2-P, S2-PO	207
S3-B	208
S3-L	211
S3-P, S3-PO	211
S3-MP	209
S3-S	210
S4-J	213
S4-L	214
S4-P, S4-PO	214
S5-L	217
S5-M	216
S5-P, S5-PO	217
S5-S	215
S7-16	220
S7-C	218
S7-I/O	219
S7-L	221
S7-P, S7-PO	221
S9-L	223
S9-M	222
S9-P, S9-PO	223

1

2

3

4

News in this catalogue



- CMC1 - Motor Controller
- CEM01 - Suppressor Module
- CIMx - Multifunctional Time Relays
- MRx - Monitoring Devices
- S5-M - System Socket for C5-Relays
- S7-C - System Socket for C7-Relays and Timers
- CMS-10 - Analogue Current Inputs and Android-App
- Contacts - Serrated Contacts on MRC, QRC and IRC



Motor controller CMC1

The CMC is a control device for DC motors and permits operation in both rotating directions for motors up to 240 W. The rotating direction can be reversed with the input signal. Alternatively, two motors or other DC devices can be operated in the same direction. The CMC1 allows also controlling lamps or electromagnets. The start and breaking ramps of the connected loads can be adjusted by two potentiometers in the time range of 0...4 seconds. The operating voltage is 12-24 VDC.

Find more information on page 90.

Monitoring devices MRx

ComatReleco has standardized the monitoring relay product range. The new MRx line covers almost every requirement in regard of voltage, current and three phase mains monitoring. The graphic display allows easy and understandable navigation through the setting menu. Different types are available for single and three phase applications as well as for analyzing of supply power quality ($\cos\phi$, f).

Find more information from page 184...189.

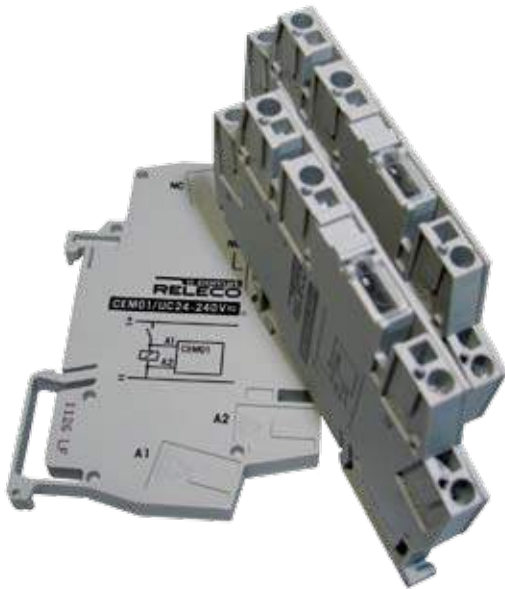


DIN-timer series CIM

The timers of the new CIM series are compact and multifunctional timer relays with totally 18 time functions and a wide power supply range from 24 to 240 V AC/DC. All the three basic types are available with relay change-over, TRIAC or MOSFET output contacts. The semi-conductor solutions are especially interesting for inductive load switching. All nine different product variants are also available as special version for railway applications.

Find more information from page 159...167.





Suppressor module CEM01

In a circuit with long electric lines, the contact of a relay can remain closed even after de-energizing of the coil. A resonant circuit can even exceed the supply voltage.

Long electric lines automatically have significant capacitive interferences. On the other hand, the coil has a very low power consumption after pull in. After the input signal is interrupted, the coil remains active because of the residual energy in the long electric line. The CEM01 includes a trigger element to absorb the current and to switch OFF after a defined current value is exceeded. After deactivation, the power consumption of the trigger element is reduced to a minimum. This is the main advantage compared to the use of a simple resistance.

Find more information on page 108.

System socket S7-C

The S7-C is a new socket, suitable for 2-pole industrial relays or timers of the C80-series. It replaces former socket S7-M fully compatible.

The socket includes new also a slot for coil bridge bus bars to interlink the neutral conductor between sockets and for overvoltage suppressing units.

The base is delivered with a retaining clip and two marking labels of white color.

Find more information on page 220.



System socket S5-M

The 11-pin socket S5-M is designed for the 3 pole power relays of the C5 series and replaces the former socket S5-S. This socket provides high contact reliability due to the new design for the faston connections.

The S5-M is made of high quality plastic to withstand aggressive environment influence. It also includes a slot for plug-in monitoring and timer modules of the CT-System.

Find more information on page 218.

SMS Relay - Analogue current inputs and Android-App

The well known and very successful SMS-Relay product line has received again a new family member.

The additional type CMS-10ACDF has four standard voltage inputs plus two 4...20 mA analogue inputs for sensor signals. Normal programming software version 3.2.4 or higher is used for the configuration of the new type.

The entire product line offers now different versions for almost every application:

- **CMS-10F/...**
with **6 digital** inputs
- **CMS-10ADF/...**
with **6 digital or analogue** voltage inputs 0...10 V
- **CMS-10ACDF/...**
with **4 digital or analogue** voltage inputs 0...10 V and
2 analogue current inputs 4...20 mA.

All these types have four relay output change over contacts.

Rather recent updates in the user configuration software are:

- «Call-In» function
- Remote access by PC/Notebook
- Message transfer by e-mail

NEW App for Android operated smartphones

The SMS-Relay can now be controlled with Android operated smartphones. The App is available on the Android market free of charge.

This makes handling, controlling, monitoring and remote switching of the SMS-Relay even more easy. After download and installation of the App, import the device configuration data's and it is ready for use.

Find more information on page 115.



Serrated contacts in the standard relays

All the standard relays of MRC, QRC and IRC series, except the C5, are now manufactured with serrated contacts. This new contact type multiplies the number of contact points, which leads to higher contact reliability of the relays.

All the other characteristics of a contact remain the same. The maximum contact load is not influenced by this modification.

Select the right relay for the right application



Reduction of contact erosion when switching DC loads

Increased contact gaps, double make contacts, and arc blow-out magnets to reduce contact erosion (burn offs).

Compared with standard contacts, the reliability can be remarkably increased when using customized contacts for switching DC loads with breakaway sparks.

Increased contact caps, double make contacts and blow out magnets are causing a longer distance for the electric arc. Electric arcs are extinguished quickly and increase significant the lifetime of the contacts.

Suitable relays for this application

Series	Type	Base	Contacts	Gap	Extras	DC-1 rating	
MRC	C2-G2x			1.7 mm		1.2 A	110 V DC
	C3-G3x			1.7 mm		1.2 A	110 V DC
	C3-M1x			2x 1.7 mm ≥ 3 mm	Double make contacts; Blow out magnet	10 A	220 V DC
	C3-X1x			2x 1.7 mm ≥ 3 mm	Double make contacts	7 A	110 V DC
	C4-X2x			2x 1.7 mm ≥ 3 mm	Double make contacts	7 A	110 V DC
	C5-G3x			1.7 mm		1.2 A	110 V DC
	C5-X1x			1.7 mm ≥ 3 mm	Double make contact	7 A	110 V DC
	C5-M1x			2x 1.7 mm ≥ 3 mm	Double make contacts; Blow out Mmagnet	10 A	220 V DC
	C5-M2x			2x 1.7 mm	Blow out magnet	7 A	110 V DC
QRC	C7-G2x			1.5 mm		0.8 A	110 V DC
	C7-X1x			2x 1.5 mm	Double make contacts	6 A	110 V DC
IRC	C10-G1x			1.0 mm		10 A	30 V DC
	C12-G2x			1.0 mm		5 A	30 V DC
DIN	CMC1	DIN 14 mm	2x		Adjustable start and breaking ramps	10 A	24 V DC



Contacts for high inrush current

Tungsten contacts have a higher melting point that help resist high power peaks and protect main contacts

High power peaks during switch-on of electrical loads, for example when switching power supplies and ballasts can lead to welding of the contacts. Early make tungsten contacts resist high inrush currents and avoid contact welding.

Suitable relays for this application

Series	Type	Base	Contacts	Extras	AC-1 rating	
QTC	C7-W1x			Tungsten early make contact; Inrush current 2.5 ms 500 A	10 A	250 V AC



Safe separation of power circuits

Relays with increased contact distance of at least 3mm allow safe separations in power circuits of high voltage currents and increase the protection degree from potentially lethal currents.

Suitable relays for this application

Serie	Type	Base	Contacts	Gap	Extras	AC-1 rating	
MRC	C3-M1x			2x 1.7 mm ≥ 3 mm	Double make contacts; Blow out magnet	10 A	250 V AC
	C3-X1x			2x 1.7 mm ≥ 3 mm	Double make contacts	10 A	250 V AC
	C4-X2x			2x 1.7 mm ≥ 3 mm	Double make contacts	10 A	250 V AC
	C5-X1x			≥ 3 mm	Double make contacts	16 A	400 V AC
	C5-M1x			≥ 3 mm	Double make contacts; Blow out magnet	16 A	400 V AC
QRC	C7-X1x			2x 1.5 mm ≥ 3 mm	Double make contacts	10 A	250 V AC



Reliable switching of low power signals

Twin contacts increase reliable switching by factors of 10 to 100 times. 10µ hard gold plated contacts help to avoid contact oxidation. Together this allows reliable switching of very low level signals through the contacts.

Low level voltages in analogue circuits and signal voltages <10V/5mA are not easily able to overcome contact resistances. Twin contacts increase contact reliability and gold contacts avoid contact oxidations and are especially suitable to switch low power signal loads.

Suitable relays for this application

Serie	Type	Base	Contacts	Extras	Min. rating	
MRC	C2-T22x			Twin contacts, 10 µ gold plated	1 mA	5 V DC
	C3-T32x			Twin contacts, 10 µ gold plated	1 mA	5 V DC
QRC	C7-T22x			Twin contacts, 10 µ gold plated	1 mA	5 V DC
	C7-H23			1 power & 1 signal contact 2 µ gold plated	5 mA	5 V DC
	C9-A42x			Contacts, 10 µ gold plated	5 mA	5 V DC
IRC	C10-T12x			Twin contacts, 10 µ gold plated	1 mA	5 V DC
	C10-GT12x			Twin contacts, 10 µ gold plated	1 mA	5 V DC
	C12-A22x			Contacts, 10 µ gold plated	5 mA	5 V DC
	CSS-DCN			NPN Solide state	1 mA	...50 V DC
	CSS-DCP			PNP Solide state	1 mA	...50 V DC
DIN	CR11C	DIN 13 mm		Twin contacts, gold plated	10 µA	10 mV DC
	CR33A	DIN 17,5 mm		Twin contact, gold plated (3 channels)	100 µA	100 mV DC
	C203.04	DIN		Gold flash over silver alloy (2 channels)	1 mA	0.1 V DC
	C301.04	DIN		Twin contacts, gold flash over silver alloy (3 channels)	1 mA	0.1 V DC


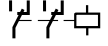

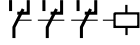

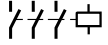




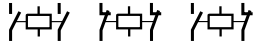
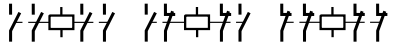
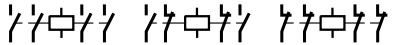
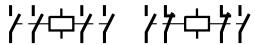


Efficient switching of high voltages high currents

Heavy duty relays are designed to switch high currents. Due to their relatively small dimensions and lower cost, these relays are more economical than contactors. Therefore control panels can be optimized for high power switching.

Heavy duty relays save space in the panel and cost less than contactors. They can be used for switching higher currents, for example electrical heaters up to 16 A at 400 V AC.

Suitable relays for this application

Series	Type	Base	Contacts	Gap	AC-1 rating	
MRC	C5-A2x				16 A	400 V AC
	C5-A3x				16 A	400 V AC
	C5-G3x			1.7 mm	16 A	400 V AC
	C5-X1x			> 3 mm	16 A	400 V AC
QRC	C7-A1x				16 A	250 V AC
RIC	RIC20	DIN 17.5 mm			20 A	400 V AC
	RIC25	DIN 35 mm			25 A	400 V DC
	RIC40	DIN 54.5 mm			40 A	400 V AC
	RIC63	DIN 54.5 mm			63 A	400 V AC




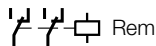

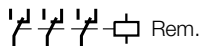

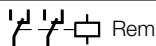

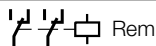

Switching with a pulse

Change the ON/OFF status of a latching relay (remanence relay) with a single pulse. The switching status remains stable also in the case of power failure.

The switching status of a latching relay is changed with a single input pulse although permanent connection is also possible. The contacts remain in position even after the “on” coil is de-energized. This guarantees that the relay status remains in position until such time that a control signal is applied to the “off” coil. A stepping relay provides an alternative for pulse switching and latching.

Latching relays help to save power dissipation, what is especially important when a hot environment is expected or when a high number of relays are mounted close with each other in a control cabinet.

Suitable relays for this application

Series	Type	Base	Contacts	Extras	Max. contact rating	
MRC	C3-R2x		 Rem.	Remanence (Latching) relay	10 A	250 V AC
	C4-R3x		 Rem.	Remanence (Latching) relay	10 A	250 V AC
	C5-R2x		 Rem.	Remanence (Latching) relay	10 A	400 V AC
QRC	C9-R2x		 Rem.	Remanence (Latching) relay	5 A	120 V AC
DIN	CRS1C	DIN 13 mm		Stepping relay	6 A	250 V AC



Max. life time and highest number of switching cycles

Long Life relays are relays of robust mechanical structure with 5 times longer life cycles compared to standard relays. Unlimited switching cycles are reached with solid state relays.

The Long Life Relays with a more robust design provide a 5 times longer service life. Standard relays are designed for 10 to 20 million mechanical switching cycles. For periodical switching frequencies in the second or minute range, the standard relays reach their life cycle within a few months. The long life relays are specially designed for frequent switching applications.

Suitable relays for this application

Serie	Type	Base	Contacts/Outputs	Extras	Max. contact rating	
MRC C20 C30	C21			> 10 ⁸ mechanical operations	10 A	250 V AC
	C22			> 10 ⁸ mechanical operations, twin contacts	5 A	250 V AC
	C31			> 10 ⁸ mechanical operations	10 A	250 V AC
	C31			> 10 ⁸ mechanical operations, twin contacts	5 A	250 V AC
CSS	CSS-AC			Solide state AC (unlimited ops.)	3 A	250 V AC
	CSS-AZ			Solide state AC (unlimited ops.)	3 A	250 V AC
	CSS-DCN			Solide state DC (unlimited ops.) NPN	2 A	50 V DC
	CSS-DCP			Solide state DC (unlimited ops.) PNP	2 A	50 V DC
RINT	RINT15	DIN 6.2 mm		Solide state DC (unlimited ops.)	2 A	33 V DC
	RINT25	DIN 6.2 mm		Solide state DC (unlimited ops.), spring cage terminal	2 A	33 V DC
	RINT18	DIN 6.2 mm		Solide state AC (unlimited ops.), spring cage terminal	0.75 A	250 V AC
	RINT28	DIN 6.2 mm		Solide state AC (unlimited ops.)	0.75 A	250 V AC
DIN	KDW3-24	DIN 17.5 mm		Solide state UC (unlimited ops.)	3 A	32 V DC
	CR11C	DIN 13 mm		> 10 ⁸ mechanical operations, twin contacts	1 A	125 V AC
	CMC1	DIN 14 mm	2x	Adjustable start and breaking ramps	10 A	24 V DC



Blinking relays

Blinking relays with integrated solid state outputs have a virtually unlimited life time independent from the switching cycles. Specially appropriate for blinking functions in intervals of seconds or minutes.

Blinking in second or minute intervals with permanent repetitions wear standard mechanical relays in a short time. A standard relay will reach the limit of its designed life time within weeks or months. Special blinking relays with integrated semi conductor contacts provide the alternative for such applications.

Suitable relays for this application

Series	Type	Base	Contacts/Outputs	Extras	Max. contact rating	
CIM	CIM1	DIN 17.5 mm		Time range adjustable 0.6 s - 60 h	16 A	250 V AC
	CIM2	DIN 17.5 mm		Time range adjustable 0.6 s - 60 h	16 A	250 V AC
	CIM12	DIN 17.5 mm		Time range adjustable 0.6 s - 60 h	2 A	250 V AC
	CIM22	DIN 17.5 mm		Time range adjustable 0.6 s - 60 h	2 A	250 V AC
	CIM13	DIN 17.5 mm		Time range adjustable 0.6 s - 60 h	5 A	30 V DC
	CIM23	DIN 17.5 mm		Time range adjustable 0.6 s - 60 h	5 A	30 V DC
























Impulse shaping (Extending short pulses)

Pulse shaper of the series CPF extend or shorten input pulses for accurate further processing by PLC's.

PLC's or other control circuits are often not able to process fast and short pulses. The pulses are conditioned with CPF pulse formers for further processing by PLC's. Fast revolution speeds and distance measurements as well as "Namur" sensor signals are conditioned with the CPF type relays for further processing.

Suitable relays for this application

Series	Type	Base	Contacts	Trigger and Outputs times	Max. contact rating	
DIN	CPF11	DIN 17.5 mm		Input 1 - 5 ms; Output 5 - 60 ms	2 A	32 V DC
	CIM1x	DIN 17.5 mm		Input min. 20 ms; Output 50 ms - 60 h	16 A	250 V AC
	CIM2x	DIN 17.5 mm		Input min. 20 ms; Output 50 ms - 60 h	16 A	250 V AC
	CIM3x	DIN 17.5 mm		Input min. 20 ms; Output 50 ms - 60 h	16 A	250 V AC
	CM3	DIN 17.5 mm		Input min. 35 ms; Output 50 ms - 60 h	5 A	250 V AC
	CRV2	DIN 13 mm		Input min. 35 ms; Output 50 ms - 60 h	6 A	250 V AC
	CSV2	DIN 13 mm		Input min. 20 ms; Output 8 ms - 10 h	1.5 A	24 V DC
	AM2	DIN 17.5 mm		Input min. 100 ms; Output 0.5 s - 60 min	10 A	250 V AC
	AM3	DIN 17.5 mm		Input min. 100 ms; Output 0.5 s - 60 min	10 A	250 V AC
C80	C83			Input min. 30 ms; Output 50 ms - 60 h	8 A	250 V AC
C60	C63			Input min. 30 ms; Output 50 ms - 60 h	6 A	250 V AC
C50	C55			Input min. 40 ms; Output 0.1 s - 60 days	5 A	250 V AC
	C56			Input min. 30 ms; Output 0.1 s - 60 days	5 A	250 V AC
CS	CS2			Input min. 50 ms; Output 50 ms - 60 h	8 A	250 V AC
	CS3			Input min. 50 ms; Output 50 ms - 60 h	6 A	250 V AC






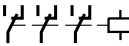




Energy saving with the same switching capacity

Relays with sensitive coils have considerably less power consumption than standard relays. This allows up to 90% energy saving with practically identical switching capacity

Relays with sensitive coils have improved and more effective magnetic circuits than coils of standard relays. The result is a considerably reduced coil current compared to a standard relay but with an almost identical switching capacity per contact. This means lower power consumption and therefore more economical operating and less heat. Under some circumstances, the user can provide a smaller power supply and save costs.

Suitable relays for this application

Series	Type	Base	Contacts	Sensitive coil	AC-1 contact rating	
MRC	C3-S1x			Nominal power 250 mW	6 A	250 V AC
	C3-E2x			Nominal power 500 mW	6 A	250 V AC
	C3-N3x			Nominal power 800 mW	6 A	250 V AC
QRC	C9-E2x			Nominal power 800 mW	5 A	250 V AC


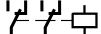



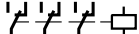
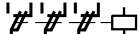


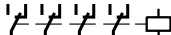



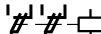









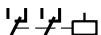




Protection against aggressive environment

A 10 μ hard gold plating of the contacts is an effective way to protect the contacts against oxidation caused by aggressive gases.

Aggressive gases may develop in sewage plants, chemical plants, or in the steel production. Conducting failures may occur on relays with standard silver nickel contacts because of contact surface oxidation. 10 μ hard gold plated contacts are especially suitable in such environments and improve the contact reliability.

Suitable relays for this application

Series	Type	Base	Contacts	Extras	AC-1 contact rating	
MRC	C2-A28			Contacts 10 μ gold plated	10 A	250 V AC
	C2-T22			Twin contacts, 10 μ gold plated	6 A	250 V AC
	C3-A38			Contacts 10 μ gold plated	10 A	250 V AC
	C3-T32			Twin contacts, 10 μ gold plated	6 A	250 V AC
	C3-S18			Contacts 10 μ gold plated	6 A	250 V AC
	C4-A48			Contacts 10 μ gold plated	10 A	250 V AC
QRC	C7-A28			Contacts 10 μ gold plated	10 A	250 V AC
	C7-T22			Twin contacts, 10 μ gold plated	6 A	250 V AC
	C9-A48			Contacts 10 μ gold plated	5 A	250 V AC
IRC	C10_A18			Contacts 10 μ gold plated	10 A	250 V AC
	C10-GT12			Twin contacts, 10 μ gold plated	6 A	250 V AC
	C10-T12			Twin contacts, 10 μ gold plated	6 A	250 V AC
	C12-A22			Contacts 10 μ gold plated	5 A	250 V AC
	C12-G22			Twin contacts, 10 μ gold plated	5 A	250 V AC



Relays according to Railway standard (increased shock and vibration resistance)

Relays as per Railway standard EN50155/EN60077/EN61373 are more suitable for applications with shock and vibration and have a higher degree of surge protection. Many of these railway relays also comply to additional fire protection standards, have lower inflammability and develop less toxic smoke and gases in case of fire.

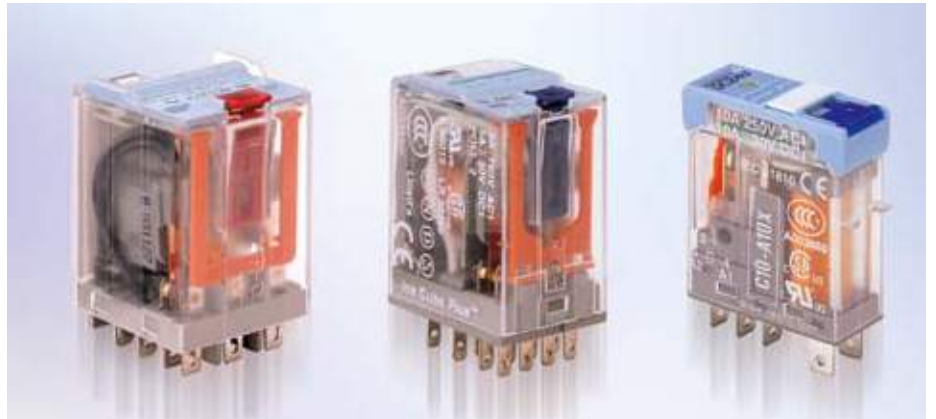
Relays specially developed to comply with railway standards are designed for higher vibration, shock and surge values and allow higher tolerance in the voltage supply. Some of these relays additionally comply to special fire protection standards in regard to inflammability and the development of toxic smoke and gases in fire accidents.

Although specially designed for railway applications these relays are also suitable for other industrial applications where increased product safety is required.

Suitable relays for this application

Series	Type	Base	Contacts	Railway standard	Max. contact rating	
MRC	R3-N3x			EN 60077-1-2/99, EN 61373/99	6 A	250 V AC
Long Life	C31			EN 50155, Fire protection NF F16-101/102	10 A	250 V AC
	C32			EN 50155, Fire protection NF F16-101/102	6 A	250 V AC
QRC	R7-A2x			EN 60077-1-2/99, EN 61373/99	10 A	250 V AC
	R7-T2x			EN 60077-1-2/99, EN 61373/99	6 A	250 V AC
DIN	C203.06R	DIN 17.5 mm		EN 50155, Fire protection NF F16-101/102	2 A	125 V AC
CIM	CIM1R	DIN 17.5 mm		EN 50155, Fire protection NF F16-101/102	16 A	250 V AC
	CIM12R	DIN 17.5 mm		EN 50155, Fire protection NF F16-101/102	2 A	250 V AC
	CIM13R	DIN 17.5 mm		EN 50155, Fire protection NF F16-101/102	5 A	30 V DC
	CIM2R	DIN 17.5 mm		EN 50155, Fire protection NF F16-101/102	16 A	250 V AC
	CIM22R	DIN 17.5 mm		EN 50155, Fire protection NF F16-101/102	2 A	250 V AC
	CIM23R	DIN 17.5 mm		EN 50155, Fire protection NF F16-101/102	5 A	30 V DC
	CIM3R	DIN 17.5 mm		EN 50155, Fire protection NF F16-101/102	16 A	250 V AC
	CIM32R	DIN 17.5 mm		EN 50155, Fire protection NF F16-101/102	2 A	250 V AC
	CIM33R	DIN 17.5 mm		EN 50155, Fire protection NF F16-101/102	5 A	30 V DC
RIC	RIC20	DIN 17.5 mm		EN 50155	20 A	400 V AC
	RIC25	DIN 35 mm		EN 50155	25 A	400 V AC
	RIC-AUX	DIN 8 mm		EN 50155	6 A	400 V AC

Relays



MRC

QRC

IRC

Product range

Releco offers a wide range of relay types and versions and associated sockets and accessories.

Standard (general-purpose) relay, MRC series

35 x 35 mm round plug-in relay, 8- or 11-terminals multipole connector according to IEC 67 with 2 or 3 contacts up to 10 A and different contact types and contact materials.

Standard relay 35 x 35 mm with flat blade connectors with up to 4 contacts and up to 16 A with 3 contacts.

Miniature industrial relay, QRC series

22.5 mm series with up to 4 contacts and up to 10 A with 1 or 2 contacts.

Interface relay, IRC series

Overall width 13 mm with up to 2 electro-mechanical contacts, or fully electronic switches.

Special relays, remanence relays

While "normal" relays are monostable, i.e. they return to the idle state when the excitation is switched off, remanence relays are bistable, i.e. the current switching state is retained irrespective of the excitation. Relays of this type are available in different versions.

Electronic relay, CSS

In the IRC series different electronic DC or AC relays up to 3 A are available. For AC relays a distinction is made between synchronously (zero crossing) and asynchronously switching versions. For switching transformer loads we recommended using asynchronously switching semiconductor switches. For incandescent lamp loads etc. synchronously switching switches are ideal for avoiding high switch-on currents.

Accessories

Suitable sockets are available for the different relay series for DIN rail mounting or panel mounting. In addition, retaining clips are available for the relays, some of which are included in the scope of supply. Suitable bridges for cost-saving wiring in series are also available.

* Special requirements

H = Orange button. No lockable function
N = Black button. No function
P = Printing board pins

E = Lap transparent cover

Z = Close transparent cover

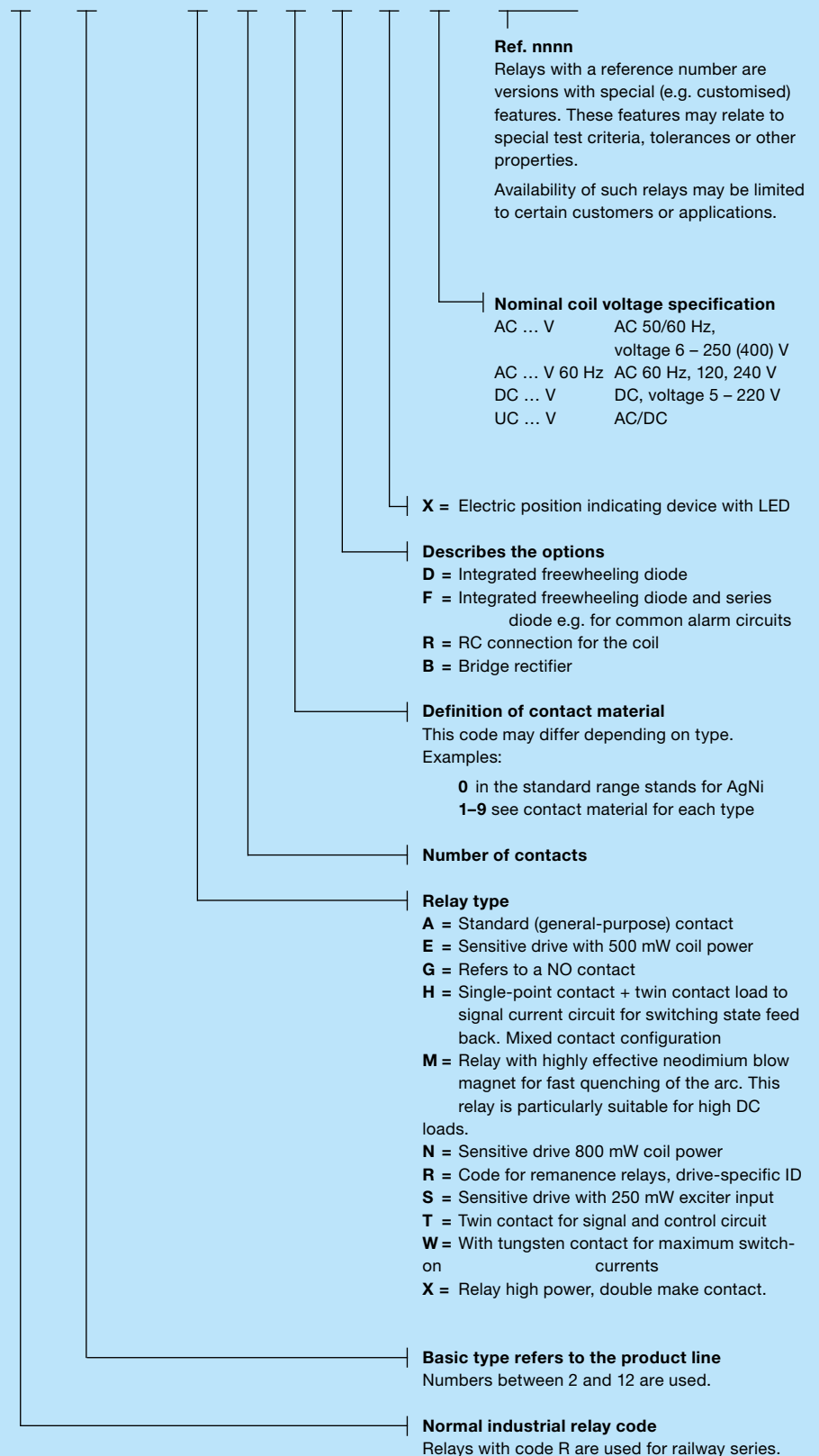
T = Close transparent cover (lamp)

M = Close transparent cover (lamp + button)

If other requirements, please consult.

Basic identification principle (type designation code electromechanical relays)

C **n(n)** - **T** **X** **y** **z(*)z** /...**V** **RF-nnnn**



MRC – QRC

Protection against transients

When the coil is disconnected from an electro-magnet, peaks of inverse voltage appear at the terminals which can reach very high values. These pulses can be transmitted down the line associated with the coil and could possibly affect other components.

In the case of a relay being operated by such devices as transistors, triacs, etc; it may be necessary to protect against transients.

Transients carried in the line

High voltage surges can be carried in the supply line to the relay coil. These may appear in the form of peaks or bursts and are generated by the connection and disconnection of electric motors, transformers, capacitors etc. Normally a relay is unaffected by these pulses, but if a diode is connected in association with the coil, it must be capable of withstanding an inverse voltage higher than those of the incoming peaks.

Protection circuits

A protection circuit must efficiently cope with pulses generated by the coil as well as incoming line surges (surges $U_{1,2/50\mu s}$). Releco relays are available with integrated protection circuits or with modules plugged into sockets S3-MP or S3-MS.

X LED indication with rectifier.
For DC and AC relays up to 250 V
Surges of 1000 V up to 24 V
Surges of 2000 V from 25 to 60 V
Surges of 4000 V from 61 to 250 V
Note: LED connected, in series with the coil @ 220 VDC in QRC types.

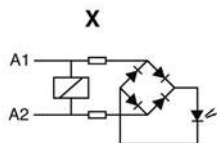
D Free-wheeling diode.
DX Free-wheeling diode + LED
Dampens transients caused by the relay coil on de-energisation.
Surges of 2000 V up to 60 VDC
Surges of 4000 V from 61 to 250 VDC (*)

F Polarity + free wheeling diode.
FX Polarity + free wheeling diode + LED
A diode in series with the coil protects the relay from reverse connection.
Surges of 1000 V up to 60 VDC
Surges of 4000 V from 61 to 250 VDC (*)

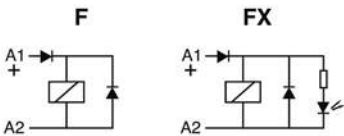
B Bridge rectifier incorporated
BX Bridge rectifier + LED indication
Allows the relay to operate in both AC or DC without any polarity inconvenience. Available only in voltages up to 60 V.
Surges of 1000 V

R Resistor and capacitor.
Suppressor for AC coils. Surges of 2000 V.
Available only in **MRC** types.

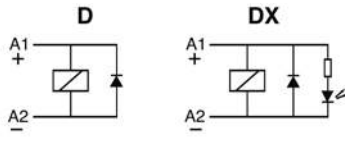
(*) Surges of 2000 V in **QRC** types.



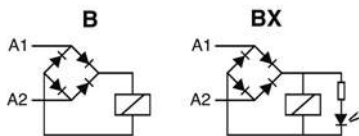
LED consumption: 1mA



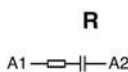
Increase release time approx. 4 times



Increases release time approx. 4 times



Increases release time approx. 3 times



IRC

LED and protection circuit connected to coil.

- X** LED with no polarity, (standard)
Coils ≤ 12 V CC y CA
LED rectifier bridge in parallel
- X** LED with no polarity, (standard)
Coils ≥ 24 V ... CC y CA
LED rectifier bridge in series
- FX** LED with polarity **A1+** (option)
Every DC coil voltage
Polarity and Free-wheeling diodes
- BX** LED with no polarity, (option)
Only 24 V and 48 V ADC coils
Rectifier bridge for AC/DC relays
- R** LED not available (option)
RC protection against pulses on AC

Protection against pulses

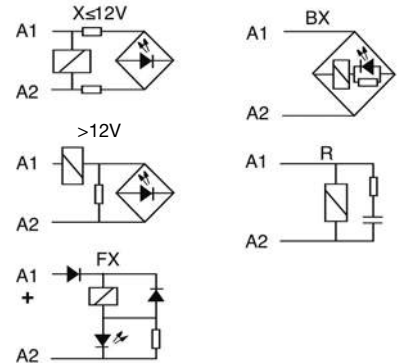
When a relay coil is disconnected, reverse voltage peaks may arise and reach very high values. Said peaks can transmit to the coil associated line and other relays or semiconductors can be affected.

If triac, transistor, etc. controls a relay, appropriate steps must be taken to avoid or decrease peaks down to a non risky level.

Both Polarity and Free-wheeling diodes (**FX**), must protect coils, to avoid malfunctions provided DC relays in battery are installed.

Making or breaking engines, transformers or contactors in an industrial environmental, may generate high voltage pulses, either isolated or burst, through the main line.

The voltage level of those pulse may be high enough to affect the isolation of the coil.



Contacts

There are different contact types. The main distinction is between single contacts and twin contacts. While single contacts are more suitable for higher loads, twin contacts are significantly more reliable at small loads, i.e. 24 V, <math>< 100\text{ mA}</math>.

Contact Material

There is no all-purpose contact! AgNi is used as standard material for a wide range of applications. AgNi contacts with hard gold plating (up to $10\text{ }\mu\text{m}$) are offered for applications in aggressive atmosphere. Relays with gold contacts are approved for relatively high currents (e.g. 6 A , 250 V), but in practice values of 200 mA , 30 V should not be exceeded for operation with intact gold plating. Relays with a tungsten pre-contact are available for very high switch-on currents (up to 500 A , 2.5 ms). For some applications AgNi contacts with gold flashing ($0.2\text{ }\mu\text{m}$) are available. The purpose is corrosion protection during storage. There is no other purpose. Tin oxide is specially appropriated for load with high-inrush current.

Minimum load

The minimum load value is a recommended value under normal conditions such as regular switching, no special ambient conditions, etc. Under these conditions reliable switching behaviour can be expected.

Contact resistance

Initial values of resistance of contact can vary with the use, load and others conditions. Typical values when the relay is new is about $50\text{ m}\Omega$.

Contact spacing

Normally all contacts have an air gap between $0,5 \dots 1,5\text{ mm}$ when they are open. They are referred to as μ contacts. According to the Low-Voltage Directive and the associated standards these contacts are not suitable for safe disconnection. For switching of DC loads large contact clearances are beneficial for quenching the arc. See special relays: series connections with a gap of 3 mm .

Switching capacity

The contact switching capacity is the product of switching voltage and switching current. For AC the permitted switching capacity is generally high enough to handle the max. continuous AC1 current over the whole voltage range. For DC the load limit curve must never be exceeded, because this would lead to a remaining switch-off arc and immediate destruction of the relay. The order of magnitude of the DC switching capacity is a few 100 W (DC 1).

Drive (coil)

The drive of a relay refers to the coil plus connections. The coil has special characteristics, depending on the rated voltage and the type of current.

Coil design

The coil consists of a plastic former (resistant up to about $130\text{ }^\circ\text{C}$) and doubly insulated high-purity copper wire, temperature class F. The winding must withstand threshold voltages (EN 61000-4-5) of more than 2000 V . This is ensured through forced separation of the start and end of the winding.

Coil resistance and other properties

Each coil has an ohmic coil resistance that can be verified with an ohmmeter. The specified coil resistance applies to a temperature of $20\text{ }^\circ\text{C}$. The tolerance is $\pm 10\%$. For AC operation the coil current will not match the ohmic value, because self-inductance plays a dominant role. At 230 V this may reach more than 90 H . When a relay is switched off, self-inductance results in a self-induced voltage that may affect the switching source (destruction of transistors, EMC problems).

Drive voltages

A distinction is made between the standardised voltages according to EN 60947 as guaranteed values, and typical values that can be expected with a high degree of probability.

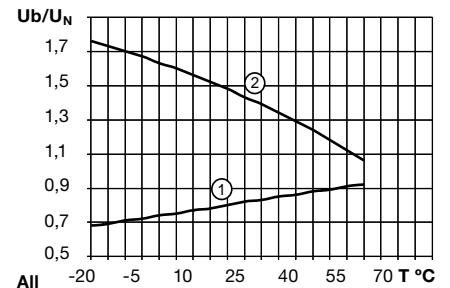
Pick-up voltage, Release voltage

The pick-up voltage is the voltage at which the relay engages safely. For DC the typical trip voltage is approx. 65% of U_{nom} , for AC approx. 75% . The release voltage, on the other hand, is approx. 25% or 60% respectively. For DC these voltages are strongly temperature-dependent, according to the temperature coefficient of Cu. This is not the case for AC, where the inductive resistance is the controlling factor, which is practically constant over a wide temperature range. With AC, in a certain undervoltage range the relay may hum, and the armature may flutter. This voltage range must be avoided.

Operating voltage range

Unless specified otherwise, the following characteristic curve applies for the operating voltage range. The upper limit of the coil voltage is determined by self-heating and the ambient temperature. Self-heating through contacts under high load must not be underestimated. It may be higher than the power dissipation in the drive.

During intermittent operation significantly higher overvoltages temporary may occur for short periods. If in doubt please consult our specialists.



General design

RELECO relays are made from high-quality, carefully selected materials. They comply with the latest environmental regulations such as RohS. Their meticulous design makes them particularly suitable for industrial applications and installation engineering. They are particularly service-friendly through robust terminals, mechanical position indicating device a standard, manual operation, dynamic, permanent characteristics. Colour coding for manual operation as a function of the coil voltage is another useful feature. Further options such as different coil connections, freewheeling diode, LED display, bridge rectifier for AC/DC drives etc., and short-term availability of special versions for practically any drive voltage up to DC 220 V / AC 400 V leave nothing to be desired. Apart from a few special versions, the standard RELECO industrial relays feature manual operation (push/pull) and a mechanical position indicating device. For safety reasons, manual operation may be replaced with a black button, if required.

Coil connections

Different coil connections can be integrated in the relay as an option. For DC a cost-effective freewheeling diode is available. Please note that the stated release times are generally specified without the coil connection. While an additional LED status indicator has practically no effect, a freewheeling diode (D) will lead to an increase in release time by a factor 2 to 5, or 0 ms to 30 ms . For AC VDRs or RC elements may be used. In this case resonance effects may have to be considered. VDRs and common RC elements may increase release times by $< 5\text{ ms}$.

Standards, conformities

While CE marking of relays/sockets is controversial, since relays are sometimes regarded as components to which the marking requirement does not apply, all RELECO relays feature the CE mark to indicate that CE standards may also be applied to the relays, e.g. 2 kV surge resistance according to EN 61000-4-5.

A significant and not generally available characteristic is that the coils and in particular the connections are able to withstand the voltage spikes that may occur in practice. In addition, the relays feature various technical approvals depending on the respective relay code, and they comply with further standards and guidelines. The main technical approvals include cURus, CSA, and CCC.

The associated information is provided in the respective data sheets.

Switching classes

EN 60947 defines different switching classes that specify the suitability of contacts for different load types.

Examples:

AC1 = Ohmic AC load

AC5b = AC incandescent lamp loads

AC15 = Power contactors, solenoid valves, solenoids






DC1 = Ohmic DC load

DC6 = DC incandescent lamps

DC13 = DC contactors, solenoids

UL508 contains different technical approval criteria such as general purpose, control application etc. Switching classes are defined based on the electrical switching capacity, e.g. B600 etc.

Main technical approvals and standards

Country	Technical approval
China	 Authority: CQC Specification GB14048.5-2001 A003850
Canada	 Authority: CSA Specification C 22,2; UL 508
Russia	 Authority: KORPORATSIA STANDART Specification GOST R 50030.5.1
USA	 Authority: UL Specification C 22,2; UL 508
United Kingdom	 Authority: GB Lloyd's Register of Shipping

Utilisation categories according to

EN 60947-4-1/-5-1

Pollution category

Cat. 1

Dry, non-conductive contamination without further effect

Cat. 2

Occasional conductive contamination, short duration due to moisture condensation

Cat. 3

Dry, non-conductive and conductive contamination with moisture condensation

Cat. 4

Contamination with persistent conductivity through conductive dust, rain

Protection class IP according to DIN 40050

and other standards. Industrial relays and their sockets can be classified as follows:

Socket IP20: Contact safety

Relay IP40/IP50: not watertight, but protected against ingress of coarse contaminants.

Further information and tips

The main operational criteria for relays such as number of cycles, switching frequency, ambient conditions, reliability requirements, load type, switch-on current, load switch-off energy must be clarified in order to ensure reliable operation and long service life.

Example

If the number of cycles is expected to exceed several 100,000 operations per year (e.g. clock generators, fast running machines), an electronic solution is no doubt more appropriate, although we also offer solutions for this type of application. In AC applications crosstalk caused by long control leads is often problem and can result in constant humming of the relay or even inadvertent triggering due to interference. Here, too, we offer solutions.

Various, apparently harmless loads may lead to very high switch-on currents or switch-off energy values, resulting in an unacceptable reduction in service life.

Particularly tricky are DC loads, particularly if they are inductive.

Circuits with relays and their connections often require a level of developer skill that is frequently no longer offered during standard education and training.

Your supplier will be very happy to provide expert advice

Characteristics of various loads:

Heating circuits

No higher switch-on currents, no higher switch-off loads.

Incandescent lamps, halogen lamps

Switch-on currents during a few ms in the range 10 ... 18 x rated. Switch-off at rated load.

Low-energy lamps

Very high, but very short switch-on currents due to built-in decoupling capacitors.

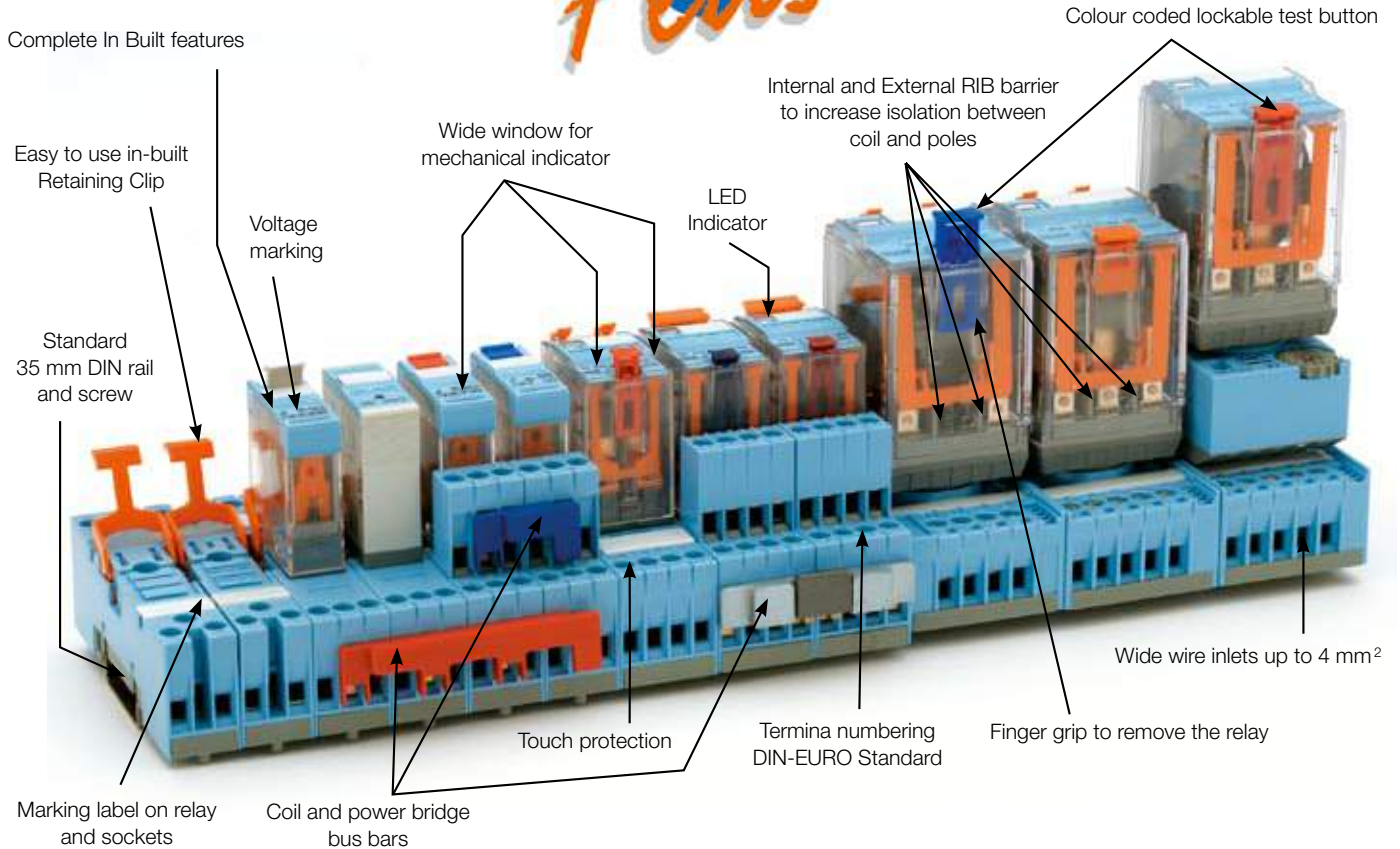
Contacts have a tendency to fuse.

Transformers, AC contactors





Switching on during zero-transition may lead to switch-on currents of 8 ... 15 x rated.

High inductive switch-off energy is possible. The load must be connected, not least due to EMC problems.

Full Features System



Five colours for an easier identification of coil voltage

-  **AC** red: 230 VAC (North America 120 VAC)
-  **AC** dark red: others VAC
-  **AU** grey: VAC/DC
-  **DC** blue: 24 VDC
-  **DC** dark blue: others VDC

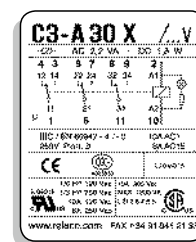
If you don't want to have the lockable function, you can use the orange "orange - push button". SO - OP for MRC - C and S9 - OP for QRC (5 pieces bag)

 Orange - push button






A black blanking plug is available if you don't want a test button. S= - NP for MR - C and S9 - NP for QRC (5 pieces bag)

 Blanking plug

Comprehensive technical label



Part number
Coil details
Additional circuit diagram for coil
Electric diagram showing all additions to the coil
Wiring diagram with sequential and DIN numbers
Maximum switching capacity according to EN 60947 (IEC 947)
Approvals

Country	Approval	Country	Approval
Canada	 Authority: CSA Specification: C 22,2: UL 508	United Kingdom	 Authority: Lloyd's Register of Shipping
China	 Authority: CQC Specification: GB14048.5-2001	USA	 Authority: UL Specification: C 22,2; UL 508
Russia	 Authority: KORPORATSIA STANDART Specification: GOST R 50030.5.1		

1.1 Plug-in Relays

1.1.1 Industrial Relays

MRC Series



Application	Types	Pins	Contacts	AC ratings	DC ratings	Socket
C2 Series						
General purpose	C2-A2x			10 A / 250 V	0.5 A / 110 V	S2
Low switching load	C2-T2x			6 A / 250 V	6 A / 30 V	S2
DC load switching	C2-G2x		1.7mm 	10 A / 250 V	1.2 A / 110 V	S2
C3 Series						
General purpose	C3-A3x			10 A / 250 V	0.5 A / 110 V	S3
Low switching load	C3-T3x			6 A / 250 V	6 A / 30 V	S3
DC load switching	C3-G3x		1.7mm 	10 A / 250 V	1.2 A / 110 V	S3
DC load switching with magnetic blow out	C3-M1x		>3mm 	10 A / 250 V	10 A / 220 V	S3
DC load switching double make	C3-X1x		>3mm 	10 A / 250V	7 A / 110 V	S3
Latching relay	C3-R2x		 Rem.	10 A / 250 V	0.5 A / 110 V	S3
Sensitive Coil 250mW ... 300mW	C3-S1x			6 A / 250 V	6 A / 30 V	S3
Sensitive Coil 500mW ... 800mW	C3-E2x			6 A / 250	6 A / 30 V	S3
Sensitive Coil 500mW ... 800mW	C3-N3x			6 A / 250	6 A / 30 V	S3
Railway application	R3-N3x			6 A / 250	6 A / 30 V	S3
C4 Series						
General purpose	C4-A4x			10 A / 250 V	0.5 A / 110 V	S4
DC load switching double make	C4-X2x		2x >3mm 	10 A / 250 V	7 A / 110 V	S4
Latching relay	C4-R3x		 Rem.	10 A / 250 V	0.5 A / 110 V	S4
C5 Series						
Power relay	C5-A2x			16 A / 400 V	0.5 A / 110 V	S5
Power relay	C5-A3x			16 A / 400 V	0.5 A / 110 V	S5
DC load switching	C5-G3x		1.7mm 	16 A / 400 V	1.2 A / 110 V	S5
DC load switching double make	C5-X1x		>3mm 	16 A / 400 V	7 A / 110 V	S5
DC load switching with magnetic blow out	C5-M1x		>3mm 	16 A / 400 V	10 A / 220 V	S5
DC load switching with magnetic blow out	C5-M2x		>3mm 	16 A / 250 V	7 A / 110 V	S5
Latching relay	C5-R2x		 Rem.	10 A / 400 V	10 A / 30 V	S5

Type	C2-A2x/ ... V Standard relay, 2 change-over contacts		
Maximum contact load	10 A/250 V AC1	0,5 A/110 V DC1	
	10 A/30 V DC1	0,2 A/220 V DC1	
Recommended minimum contact load	10 mA/10 V Code 0, 9 5 mA/5 V Code 8		

Contacts			
Material	Standard	Code 0	AgNi
	Optional	Code 8	AgNi + 10 μ Au
	Optional	Code 9	AgNi + 0,2 μ Au
Max. switching current	10 A		
Max. peak inrush current (20 ms.)	30 A		
Max. switching voltage	250 V		
Max. AC load (Fig 1 1)	2,5 kVA		
Max. DC load	See Fig 2		

Coils			
Coil resistance	see table; tolerance ± 10 %		
Pull-in voltage	≤ 0,8 x U _N		
Pull-in voltage	≥ 0,1 x U _N		
Nominal power	2,2 VA (AC)/1,3 W (DC)		

Table	VAC	Ω	mA	VDC	Ω	mA
	24	67	92	24	443	54
	48	296	46	48	1K8	27
	115	1K7	19	110	9K2	12
	230	7K1	9,5	220	36K1	6

Insulation	Volt rms, 1 min
Open contact	1000 V
Between adjacent poles	2,5 kV
Between contacts and coil	2,5 kV
Insulation resistance at 500 V	≥ 1 GΩ
Insulation, IEC 61810-1	2,5 kV/3

Specifications	
Ambient temperature operation/storage	-40 (no ice)...60 °C /-40 ... 80 °C
Pick-up time + bounce time	16 ms/≤ 3 ms
Release time + bounce time	8 ms/≤ 1 ms
Mechanical life ops	AC: 10 Mill./DC: 20 Mill.
DC voltage endurance at rated load	≥ 100000 ops. switching cycles
Operating frequency at nominal load	≤ 1200/ops/h
Protection degree	IP40
Weight	90 g

Standard types			
VAC 50 Hz/60 Hz: 24, 48, 115 (120), 230 (240)	C2-A20/AC ... V	C2-A28/AC ... V	C2-A29AC ... V
LED	C2-A20X/AC ... V	C2-A28X/AC ... V	C2-A29X/AC ... V
RC Suppressor	C2-A20R/AC ... V	C2-A28R/AC ... V	C2-A29R/AC ... V
VDC 24, 48, 110, 220	C2-A20/DC ... V	C2-A28/DC ... V	C2-A29/DC ... V
LED	C2-A20X/DC ... V	C2-A28X/DC ... V	C2-A29X/DC ... V
Free wheeling diode	C2-A20DX/DC ... V	C2-A28DX/DC ... V	C2-A29DX/DC ... V
Polarity and free wheeling diode	C2-A20FX/DC ... V	C2-A28FX/DC ... V	C2-A29FX/DC ... V
AC/DC bridge rectifier 24 V, 48 V, 60 V	C2-A20BX/UC ... V	C2-A28BX/UC ... V	C2-A29BX/UC ... V

"..." Enter the voltage for full type designation

Accessories	
Socket:	S2-B, S2-S, S2-L, S2-P, S2-P0
Optional accessories (blanking plug):	SO-NP, SO-OP



Connection diagram

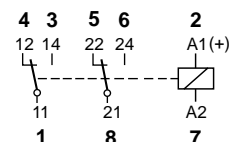


Fig. 1 AC voltage endurance

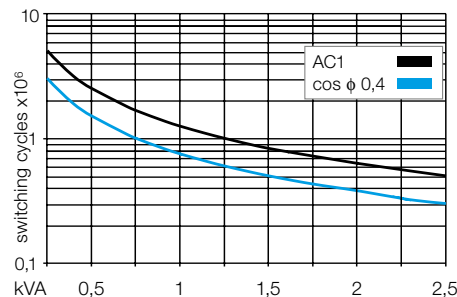
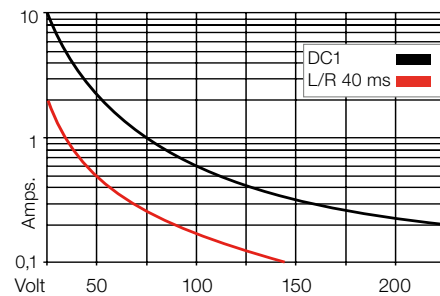
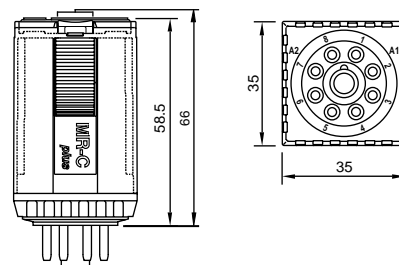


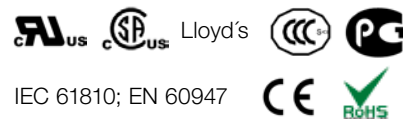
Fig. 2 DC load limit curve



Dimensions [mm]



Technical approvals, conformities



Type	C2-T2x/ ... V Standard relay for low level 2 Change-over contacts			
Maximum contact load	6 A/250 V	AC1	6 A/30 V	DC1
Recommended minimum contact load	5 mA/5 V	Code 1		
	1 mA/5 V	Code 2		

Contacts			
Material	Standard	Code 1	AgNi + 0,2 μ Au
	Optional	Code 2	AgNi + 10 μ Au
Rated current	6 A		
Switch-on current max. (20 ms)	15 A		
Switching voltage max.	250 V		
AC load (Fig 1)	1,2 kVA		
DC load	see Fig. 2		

Coil			
Coil resistance	see table; tolerance ± 10 %		
Pick-up voltage	≤ 0,8 × U _N		
Release voltage	≥ 0,1 × U _N		
Nominal power	2,2 VA (AC)/1,3 W (DC)		

Coil table					
VAC	Ω	mA	VDC	Ω	mA
24	67	92	24	443	54
48	296	46	48	1K8	27
115	1K7	19	110	9K2	12
230	7K1	9,5	220	36K1	6

Insulation		Volt rms, 1 min
Contact open	1000 V	
Contact/contact	2,5 kV	
Contact/coil	2,5 kV	
Insulation resistance at 500 V	≥ 1 GΩ	
Insulation, IEC 61810-1	2,5 kV/3	

Specifications	
Ambient temperature operation/storage	-40 (no ice)...60 °C / -40 ... 80 °C
Pick-up time/bounce time	16 ms/≤ 3 ms
Release time/bounce time	8 ms/≤ 1 ms
Mechanical life ops	AC: 10 Mill./DC: 20 Mill.
DC voltage endurance at rated load	≥ 100000 switching cycles
Switching frequency at rated load	≤ 1200/ops/h
Protection class	IP40
Weight	90 g

Standard types		
VAC 50 Hz/60 Hz: 24, 48, 115 (120), 230 (240)	C2-T21/AC ... V	C2-T22/AC ... V
LED	C2-T21X/AC ... V	C2-T22X/AC ... V
RC Suppressor	C2-T21R/AC ... V	C2-T22R/AC ... V
VDC 24, 48, 110, 220	C2-T21/DC ... V	C2-T22/DC ... V
LED	C2-T21X/DC ... V	C2-T22X/DC ... V
Free wheeling diode	C2-T21DX/DC ... V	C2-T22DX/DC ... V
Polarity and free wheeling diode	C2-T21FX/DC ... V	C2-T22FX/DC ... V
AC/DC bridge rectifier 24 V, 48 V, 60 V	C2-T21BX/UC ... V	C2-T22BX/UC ... V

"..." Enter the voltage for full type designation

Accessories	
Socket:	S2-B, S2-S, S2-L, S2-P, S2-P0
Optional accessories (blanking plug):	SO-NP, SO-OP



Connection diagram

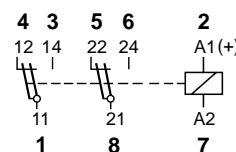


Fig. 1 AC voltage endurance

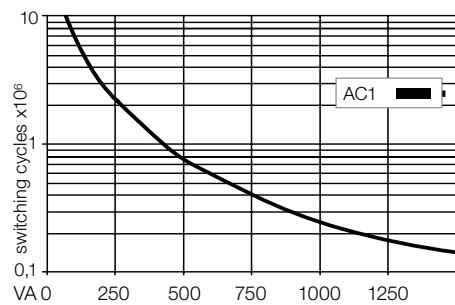
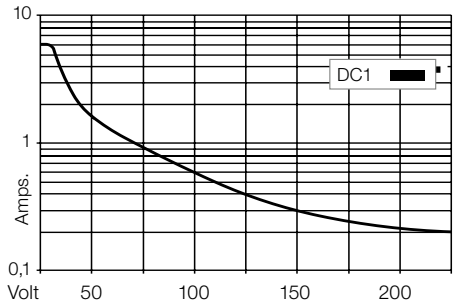
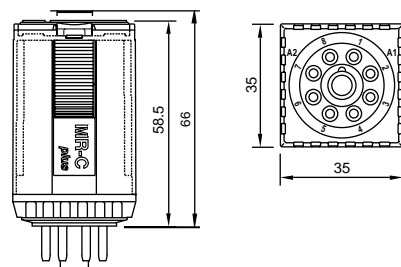


Fig. 2 DC load limit curve



Dimensions [mm]



Technical approvals, conformities



IEC 61810; EN 60947



Type	C2-G2x/ ... V Standard relays, DC application 2 open contacts		
-------------	--	--	--

Maximum contact load	10 A/250 V AC1	1,2 A/110 V DC1
	10 A/30 V DC1	0,4 A/220 V DC1

Contacts			
Material	Standard	Code 0	AgNi
Rated current			10 A
Switch-on current max. (20 ms)			30 A
Switching voltage max.			250 V
AC load (Fig 1)			2,5 kVA
DC load			see Fig. 2

Coil	
Coil resistance	see table; tolerance $\pm 10\%$
Pick-up voltage	$\leq 0,8 \times U_N$
Release voltage	$\geq 0,1 \times U_N$
Nominal power	2,4 VA (AC)/1,6 W (DC)

Coil table	VAC	Ω	mA	VDC	Ω	mA
	24	65	100	24	360	66
	48	286	50	48	1K4	34
	115	1K7	21	110	7K6	15
	230	6K8	10	220	30K3	7,5

Insulation	Volt rms, 1 min
Contact open	2000 V
Contact/contact	2,5 kV
Contact/coil	2,5 kV
Insulation resistance at 500 V	$\geq 1 \text{ G}\Omega$
Insulation, EN 61810-1	2,5 kV/3

Specifications	
Ambient temperature operation/storage	-40 (no ice)...60 °C /-40 ... 80 °C
Pick-up time/bounce time	20 ms/ $\leq 3 \text{ ms}$
Release time/bounce time	8 ms/ $\leq 1 \text{ ms}$
Mechanical life ops	AC: 10 Mill./DC: 20 Mill.
DC voltage endurance at rated load	≥ 100000 switching cycles
Switching frequency at rated load	≤ 1200 /ops/h
Protection class	IP40
Weight	90 g

Standard types	C2-G20/AC ... V
VAC 50 Hz/60 Hz: 24, 48, 115 (120), 230 (240)	C2-G20X/AC ... V
LED	C2-G20R/AC ... V
RC Suppressor	
VDC 24, 48, 110, 220	C2-G20/DC ... V
LED	C2-G20X/DC ... V
Free wheeling diode	C2-G20DX/DC ... V
Polarity and free wheeling diode	C2-G20FX/DC ... V
AC/DC bridge rectifier 24 V, 48 V, 60 V	C2-G20BX/UC ... V

"..." Enter the voltage for full type designation

Accessories	
Socket:	S2-B, S2-S, S2-L, S2-P, S2-P0
Optional accessories (blanking plug):	SO-NP, SO-OP

Connection diagram

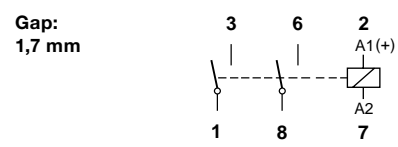


Fig. 1 AC voltage endurance

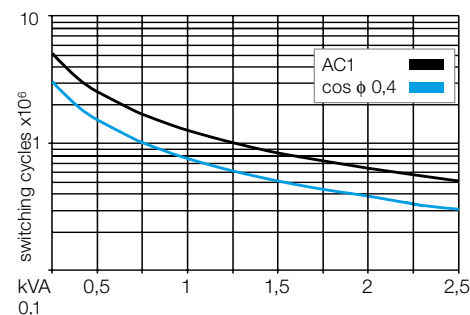
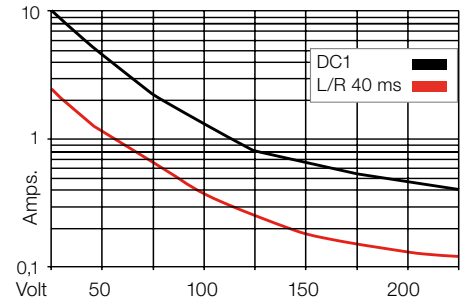
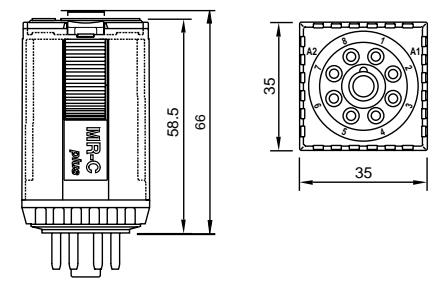


Fig. 2 DC load limit curve



Dimensions [mm]



Technical approvals, conformities



IEC 61810; EN 60947

Type	C3-A3x/ ... V Standard relays, 3 change-over contacts		
Maximum contact load	10 A/250 ACI	0,5 A/110 V DC1	
	10 A/30 DCI	0,2 A/220 V DC1	
Recommended minimum contact load	10 mA/10 V Code 0, 9		
	5 mA/5 V Code 8		

Contacts			
Material	Standard	Code 0	AgNi
	Optional	Code 8	AgNi + 10 μ Au
	Optional	Code 9	AgNi + 0,2 μ Au
Rated current	10 A		
Switch-on current max. (20 ms)	30 A		
Switching voltage max.	250 V		
AC load (Fig 1)	2,5 kVA		
DC load	see Fig. 2		

Coil	
Coil resistance	see table; tolerance ± 10 %
Pick-up voltage	≤ 0,8 × U _N
Release voltage	≥ 0,1 × U _N
Nominal power	2,2 VA (AC)/1,3 W (DC)

Coil table						
	VAC	Ω	mA	VDC		mA
	24	67	92	24	443	54
	48	296	46	48	1K8	27
	115	1K7	19	110	9K2	12
	230	7K1	9,5	220	36K1	6

Insulation	Volt rms, 1 min
Contact open	1000 V
Contact/contact	2,5 kV
Contact/coil	2,5 kV
Insulation resistance at 500 V	≥ 1 GΩ
Insulation, IEC 61810-1	2,5 kV/3

Specifications	
Ambient temperature operation/storage	-40 (no ice)...60 °C /-40 ... 80 °C
Pick-up time/bounce time	16 ms/≤ 3 ms
Release time/bounce time	8 ms/≤ 1 ms
Mechanical life ops	AC: 10 Mill./DC: 20 Mill.
DC voltage endurance at rated load	≥ 100000 switching cycles
Switching frequency at rated load	≤ 1200/ops/h
Protection class	IP40
Weight	90 g

Standard types			
VAC 50 Hz/60 Hz: 24, 48, 115 (120), 230 (240)	C3-A30/AC ... V	C3-A38/AC ... V	C3-A39/AC ... V
LED	C3-A30X/AC ... V	C3-A38X/AC ... V	C3-A39X/AC ... V
RC Suppressor	C3-A30R/AC ... V	C3-A38R/AC... V	C3-A39R/AC... V
VDC 24, 48, 110, 220	C3-A30/DC ... V	C3-A38/DC ... V	C3-A39/DC ... V
LED	C3-A30X/DC ... V	C3-A38X/DC ... V	C3-A39X/DC ... V
Free wheeling diode	C3-A30DX/DC ... V	C3-A38DX/DC ... V	C3-A39DX/DC ... V
Polarity and free wheeling diode	C3-A30FX/DC ... V	C3-A38FX/DC ... V	C3-A39FX/DC ... V
AC/DC bridge rectifier 24 V, 48 V, 60 V	C3-A30BX/UC ... V	C3-A38BX/UC ... V	C3-A39BX/UC ... V

"..." Enter the voltage for full type designation

Accessories	
Socket:	S3-B, S3-S, S3-L, S3-P, S3-P0, S3-MP, S3-MS
Optional accessories (blanking plug):	SO-NP, SO-OP



Connection diagram

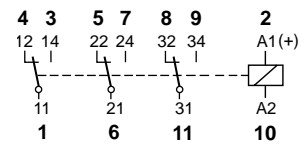


Fig. 1 AC voltage endurance

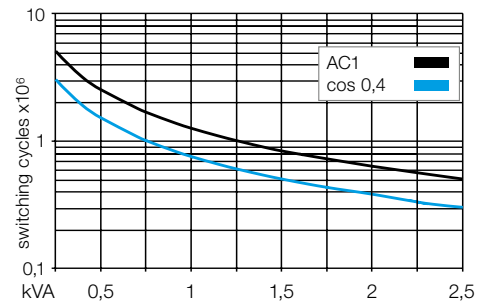
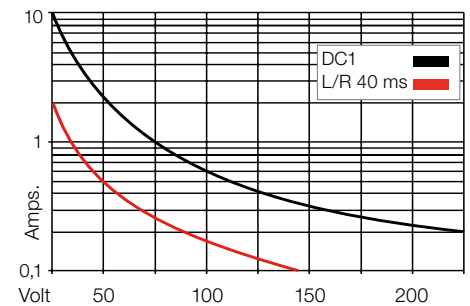
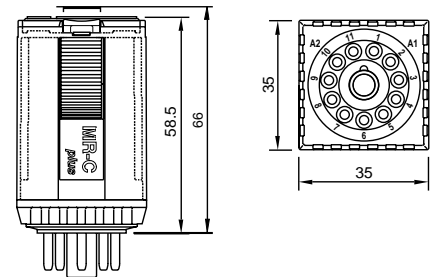


Fig. 2 DC load limit curve



Dimensions [mm]



Technical approvals, conformities



C3-T3x

11-pin standard relay, 3-pole, twin contact, plug-in according to IEC 67-I-18a

Type	C3-T3x/ ... V Standard relays for low level 3 change-over twin contacts			
Maximum contact load	6 A/250 V	AC 1	6 A/30 V	DC1
Recommended minimum contact load	5 mA/5 V	Code 1		
	1 mA/5 V	Code 2		

Contacts				
Material	Standard	Code 1	AgNi + 0,2 μ Au	
	Optional	Code 2	AgNi + 10 μ Au	
Rated current	6 A			
Switch-on current max. (20 ms)	15 A			
Switching voltage max.	250 V			
AC load (Fig 1)	1,2 kVA			
DC load	see Fig. 2			

Coil				
Coil resistance	see table; tolerance ± 10 %			
Pick-up voltage	≤ 0,8 × U _N			
Release voltage	≥ 0,1 × U _N			
Nominal power	2,2 VA (AC)/1,3 W (DC)			

Coil table					
VAC	Ω	mA	VDC	Ω	mA
24	67	92	24	443	54
48	296	46	48	1K8	27
115	1K7	19	110	9K2	12
230	7K1	9,5	220	36K1	6

Insulation		Volt rms, 1 min
Contact open		1000 V
Contact/contact		2,5 kV
Contact/coil		2,5 kV
Insulation resistance at 500 V		≥ 1 GΩ
Insulation, EN 61810-1		2,5 kV/3

Specifications	
Ambient temperature operation/storage	-40 (no ice)...60 °C /-40 ... 80 °C
Pick-up time/bounce time	16 ms/≤ 3 ms
Release time/bounce time	8 ms/≤ 1 ms
Mechanical life ops	AC: 10 Mill./DC: 20 Mill.
DC voltage endurance at rated load	≥ 100000 switching cycles
Switching frequency at rated load	≤ 1200/ops/h
Protection class	IP40
Weight	90 g

Standard types		
VAC 50 Hz/60 Hz: 24, 48, 115 (120), 230 (240)	C3-T31/AC ... V	C3-T32/AC ... V
LED	C3-T31X/AC ... V	C3-T32X/AC ... V
RC Suppressor	C3-T31R/AC ... V	C3-T32R/AC ... V
VDC 24, 48, 110, 220	C3-T31/DC ... V	C3-T32/DC ... V
LED	C3-T31X/DC ... V	C3-T32X/DC ... V
Free wheeling diode	C3-T31DX/DC ... V	C3-T32DX/DC ... V
Polarity and free wheeling diode	C3-T31FX/DC ... V	C3-T32FX/DC ... V
AC/DC bridge rectifier 24 V, 48 V, 60 V	C3-T31BX/UC ... V	C3-T32BX/UC ... V

"..." Enter the voltage for full type designation

Accessories	
Socket:	S3-B, S3-S, S3-L, S3-P, S3-P0, S3-MP, S3-MS
Optional accessories (blanking plug):	SO-NP, SO-OP



Connection diagram

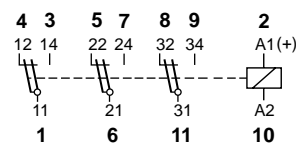


Fig. 1 AC voltage endurance

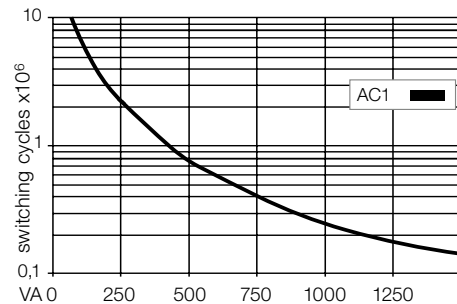
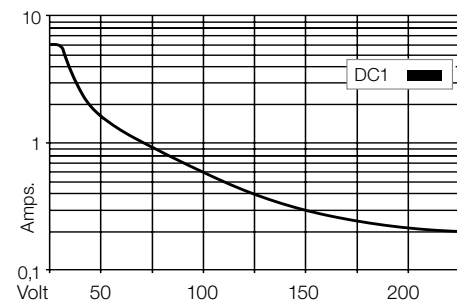
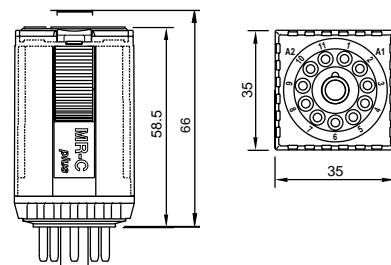


Fig. 2 DC load limit curve



Dimensions [mm]



Technical approvals, conformities



IEC 61810; EN 60947

Type	C3-G3x/ ... V Standard relays, DC application 3 open contacts		
-------------	--	--	--

Maximum contact load	10 A 250 V AC 1	1,2 A/110 V DC1
	10 A 30 V DC 1	0,4 A/220 V DC1

Contacts			
Material	Standard	Code 0	AgNi
Rated current			10 A
Switch-on current max. (20 ms)			30 A
Switching voltage max.			250 V
AC load (Fig 1)			2,5 kVA
DC load			see Fig. 2

Coil	
Coil resistance	see table; tolerance ± 10 %
Pick-up voltage	≤ 0,8 x U _N
Release voltage	≥ 0,1 x U _N
Nominal power	2,4 VA (AC)/1,6 W (DC)

Coil table	VAC	Ω	mA	VDC	Ω	mA
	24	65	100	24	360	66
	48	286	50	48	1K4	34
	115	1K7	21	110	7K6	15
	230	6K8	10	220	30K3	7,5

Insulation	Volt rms, 1 min
Contact open	2000 V
Contact/contact	2,5 kV
Contact/coil	2,5 kV
Insulation resistance at 500 V	≥1 GΩ
Insulation, IEC 61810-1	2,5 kV/3

Specifications	
Ambient temperature operation/storage	-40 (no ice)...60 °C /-40 ... 80 °C
Pick-up time/bounce time	20 ms/≤ 3 ms
Release time/bounce time	8 ms/≤ 1 ms
Mechanical life ops	AC: 10 Mill./DC: 20 Mill.
DC voltage endurance at rated load	≥100000 switching cycles
Switching frequency at rated load	≤ 1200/ops/ h
Protection class	IP40
Weight	90 g

Standard types	
VAC 50 Hz/60 Hz: 24, 48, 115 (120), 230 (240)	C3-G30/AC ... V
LED	C3-G30X/AC ... V
RC Suppressor	C3-G30R/AC ... V
VDC 24, 48, 110, 220	C3-G30/DC ... V
LED	C3-G30X/DC ... V
Free wheeling diode	C3-G30DX/DC... V
Polarity and free wheeling diode	C3-G30FX/DC ... V
AC/DC bridge rectifier 24 V, 48 V, 60 V	C3-G30BX/UC ... V

"..." Enter the voltage for full type designation

Accessories	
Socket:	S3-B, S3-S, S3-L, S3-P, S3-P0, S3-MP, S3-MS
Optional accessories (blanking plug):	SO-NP, SO-OP



Connection diagram

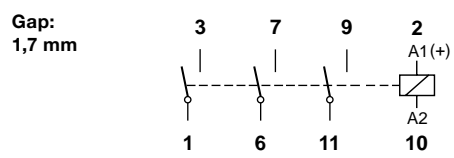


Fig. 1 AC voltage endurance

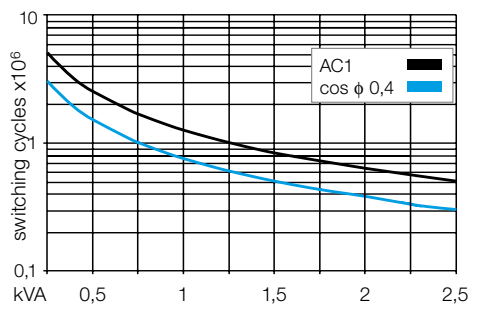
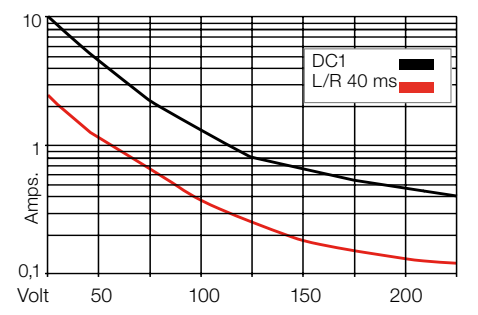
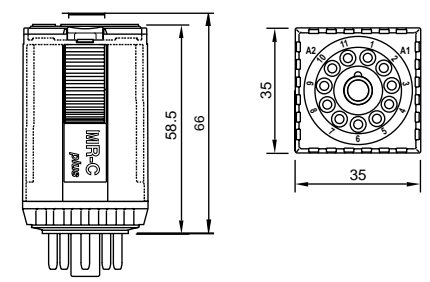


Fig. 2 DC load limit curve



Dimensions [mm]



Technical approvals, conformities



IEC 61810; EN 60947

Type	C3-M1x/ ... V Power relays, DC, application 1 pole, magnetic blow out
-------------	--

Maximum contact load	10 A 250 V AC1 10 A 220 V DC1 3,6 A 110 V L/R 40ms 2 A 220 V L/R 40ms
-----------------------------	--

Contacts			
Material	Standard	Code 0	AgNi
Rated current			10 A
Switch-on current max. (20 ms)			30 A
Switching voltage max.			250 V
AC load (Fig 1)			2,5 kVA
DC load			see Fig. 2

Coil	
Coil resistance	see table; tolerance ± 10 %
Pick-up voltage	≤ 0,8 × U _N
Release voltage	≥ 0,1 × U _N
Nominal power	2,4 VA (AC) / 1,3 W (DC)

Coil table																															
	<table border="1"> <thead> <tr> <th>VAC</th> <th>Ω</th> <th>mA</th> <th>VDC</th> <th>Ω</th> <th>mA</th> </tr> </thead> <tbody> <tr> <td>24</td> <td>65</td> <td>100</td> <td>24</td> <td>443</td> <td>54</td> </tr> <tr> <td>48</td> <td>286</td> <td>50</td> <td>48</td> <td>1K7</td> <td>27</td> </tr> <tr> <td>115</td> <td>1K7</td> <td>21</td> <td>110</td> <td>9K2</td> <td>12</td> </tr> <tr> <td>230</td> <td>6K8</td> <td>10</td> <td>220</td> <td>36K1</td> <td>6</td> </tr> </tbody> </table>	VAC	Ω	mA	VDC	Ω	mA	24	65	100	24	443	54	48	286	50	48	1K7	27	115	1K7	21	110	9K2	12	230	6K8	10	220	36K1	6
VAC	Ω	mA	VDC	Ω	mA																										
24	65	100	24	443	54																										
48	286	50	48	1K7	27																										
115	1K7	21	110	9K2	12																										
230	6K8	10	220	36K1	6																										

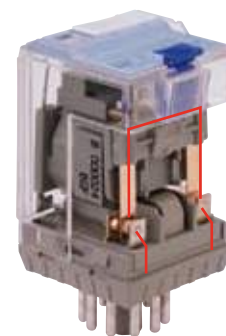
Insulation	Volt rms, 1 min
Contact open	2500 V
Contact/contact	2,5 kV
Contact/coil	2,5 kV
Insulation resistance at 500 V	≥ 1 G.Ω
Insulation, IEC 61810-1:	2,5 KV / 3

Specifications	
Ambient temperature operation/storage	-40 (no ice)...60 °C / -40 ... 80 °C
Nominal coil power	2,4 VA (AC), 1,3 W (DC)
Pick-up time/bounce time	20 ms/≤ 3 ms
Release time/bounce time	10 ms/≤ 1 ms
Isolation: EN 60947, pollution rate 3, Gr C	250 V
Dielectric strength, Contact/Coil	2,5 KV

Standard types	
VAC 50 Hz/60 Hz: 24, 48, 115 (120), 230 (240)	C3-M10/AC ... V
LED	C3-M10X/AC ... V
RC Suppressor	C3-M10R/AC ... V
VDC 24, 48, 110, 220	C3-M10/DC ... V
LED	C3-M10X/DC ... V
Free wheeling diode	C3-M10DX/DC ... V
Polarity and free wheeling diode	C3-M10FX/DC ... V
AC/DC bridge rectifier 24 V, 48 V, 60 V	C3-M10BX/UC ... V

"..." Enter the voltage for full type designation

Accessories	
Socket:	S3-B, S3-S, S3-L, S3-P, S3-P0, S3-MP, S3-MS
Optional accessories (blanking plug):	SO-NP, SO-OP



Connection diagram

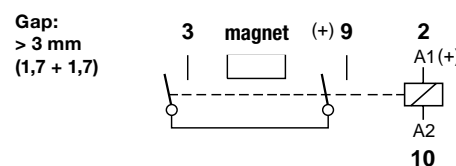


Fig. 1 AC voltage endurance

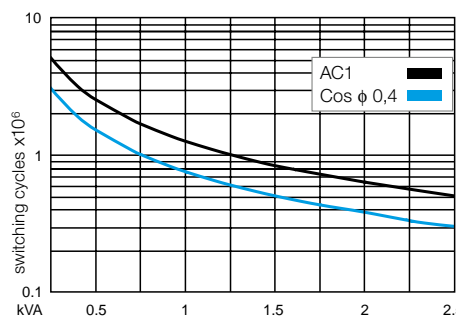
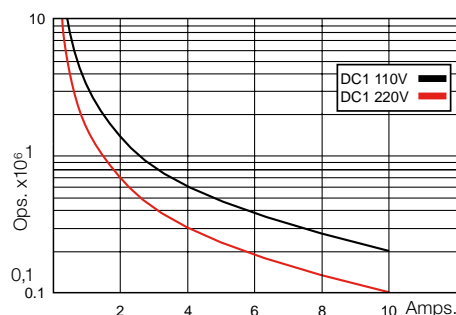
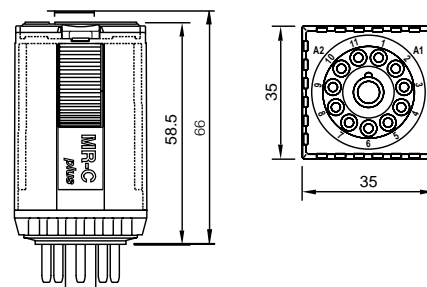


Fig. 2 DC voltage endurance



Dimensions [mm]



Technical approvals, conformities



IEC 61810; EN 60947

Type **C3-X1x/ ... V**
 Power relays for DC application
 1 pole, NO, double make

Maximum contact load	10 A/250 V AC 1	7 A/110 V DC1
	10 A/30 V DC 1	1,2 A/220 V DC1

Contacts

Material	Standard	Code 0	AgNi
Rated current			10 A
Switch-on current max. (20 ms)			30 A
Switching voltage max.			250 V
AC load (Fig 1)			2,5 kVA
DC load			see Fig. 2

Coil

Coil resistance	see table; tolerance ± 10 %
Pick-up voltage	≤ 0,8 x U _N
Release voltage	≥ 0,1 x U _N
Nominal power	2,4 VA (AC)/1,3 W (DC)

Coil table

VAC	Ω	mA	VDC	Ω	mA
24	65	100	24	443	54
48	286	50	48	1K7	27
115	1K7	21	110	9K2	12
230	6K8	10	220	36K1	6

Insulation

	Volt rms, 1 min
Contact open	2500 V
Contact/contact	2,5 kV
Contact/coil	2,5 kV
Insulation resistance at 500 V	≥ 1 GΩ
Insulation, IEC 61810-1	2,5 kV/3

Specifications

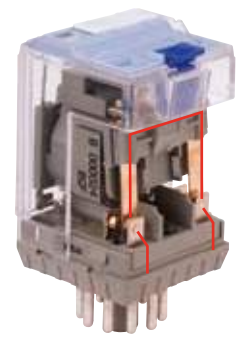
Ambient temperature operation/storage	-40 (no ice)...60 °C /-40 ... 80 °C
Pick-up time/bounce time	20 ms/≤ 3 ms
Release time/bounce time	10 ms/≤ 1 ms
Mechanical life ops	AC: 10 Mill./DC: 20 Mill.
DC voltage endurance at rated load	≥ 100000 switching cycles
Switching frequency at rated load	≤ 1200/ops/h
Protection class	IP40
Weight	90 g

Standard types	C3-X10/AC ... V
VAC 50 Hz/60 Hz: 24, 48, 115 (120), 230 (240)	C3-X10X/AC ... V
LED	C3-X10R/AC ... V
RC Suppressor	
VDC 24, 48, 110, 220	C3-X10/DC ... V
LED	C3-X10X/DC ... V
Free wheeling diode	C3-X10DX/DC ... V
Polarity and free wheeling diode	C3-X10FX/DC ... V
AC/DC bridge rectifier 24 V, 48 V, 60 V	C3-X10BX/UC ... V

"..." Enter the voltage for full type designation

Accessories

Socket:	S3-B, S3-S, S3-L, S3-P, S3-P0, S3-MP, S3-MS
Optional accessories (blanking plug):	SO-NP, SO-OP



Connection diagram

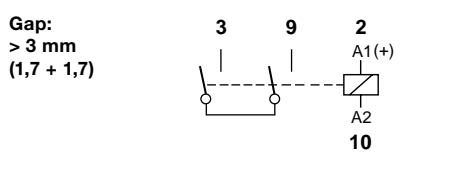


Fig. 1 AC voltage endurance

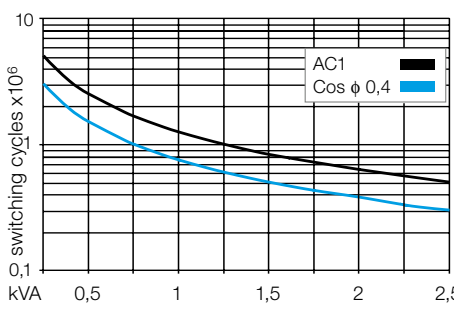
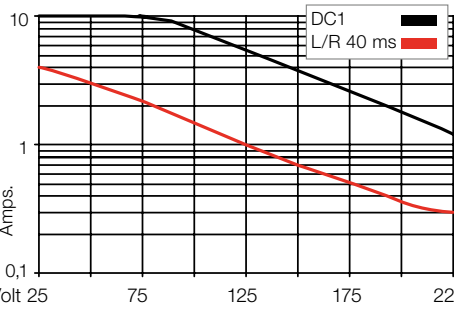
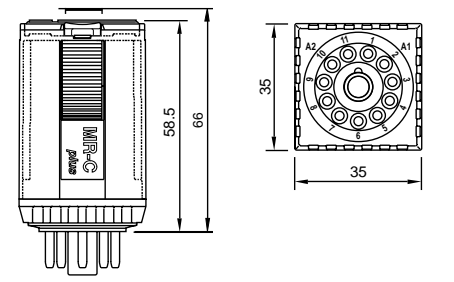


Fig. 2 DC load limit curve



Dimensions [mm]



Technical approvals, conformities



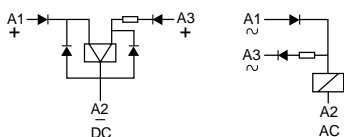
IEC 61810; EN 60947

Type	C3-R2x/ ... V Remanence plug-in relays, 2 change-over contacts		
Maximum contact load	10 A/250 V AC1	0,5 A/110 V DC1	
	10 A/30 V DC1	0,2 A/220 V DC1	
Recommended minimum contact load	10 mA/10 V Code 0, 9		
	5 mA/5 V Code 8		

Contacts			
Material	Standard	Code 0	AgNi
	Optional	Code 8	AgNi + 10 μ Au
	Optional	Code 9	AgNi + 0,2 μ Au
Rated current	10 A		
Switch-on current max. (20 ms)	30 A		
Switching voltage max.	250 V		
AC load (Fig 1)	2,5 kVA		
DC load	see Fig. 2		

Coil	
Coil resistance	see table; tolerance ± 10 %
ON pulse power	1,5 VA/W
OFF pulse power	0,5 VA/W
Pull-in ON/OFF	≤ 0,8 x U _N

Internal Diagram:



Coil table

VAC	mA ON	mA OFF	VDC	mA ON	mA OFF
24	75	12	12	125	41
48	38	6	24	63	21
115	16	2,5	48	31	10
230	8	1,3	110	14	4,5

Insulation	Volt rms, 1 min
Contact open	1000 V
Contact/contact	2,5 kV
Contact/coil	2,5 kV
Insulation resistance at 500 V	≥ 1 GΩ
Insulation, IEC 61810-1	2,5 kV/3

Specifications	
Ambient temperature operation/storage	-40 (no ice)...60 °C / -40 ... 80 °C
Minimum pulse length for ON/OFF	50 ms
Mechanical life ops	10 Mill.
DC voltage endurance at rated load	≥ 100000 switching cycles
Switching frequency at rated load	≤ 1200/ops/h
Protection class	IP40
Weight	95 g

Standard types			
VAC 50 Hz/60 Hz: 24, 48, 115 (120), 230 (240)	C3-R20/AC ... V	C3-R28/AC ... V	C3-R29/AC ... V
VDC 12, 24, 48, 110	C3-R20/DC ... V	C3-R28/DC ... V	C3-R29/DC ... V

"..." Enter the voltage for full type designation

Accessories	
Socket:	S3-B, S3-S, S3-L, S3-P, S3-P0, S3-MP, S3-MS
Optional accessories (blanking plug):	SO-NP, SO-OP



Connection diagram

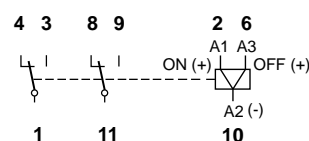


Fig. 1 AC voltage endurance

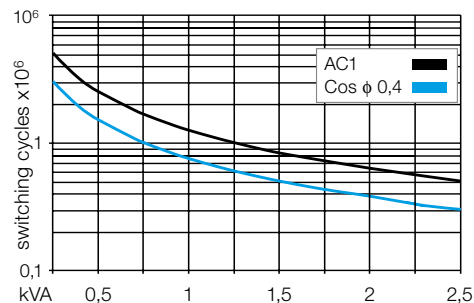
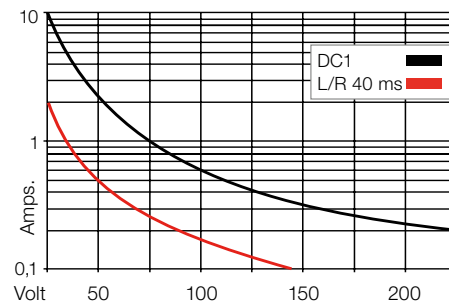
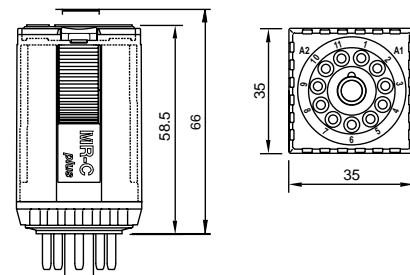


Fig. 2 DC load limit curve



Dimensions [mm]



Technical approvals, conformities



IEC 61810; EN 60947

Type	C3-S1x/ DC... V Sensitive relays, 250 mW, 1 change-over contacts		
Operating range	0,8 ... 2,5 x Un		
Maximum contact load	6 A/250 V AC1	6 A/30 V DC1	
Recommended minimum contact load	10 mA/10 V Code 4 5 mA/5 V Code 8		

Contacts			
Material	Standard, Code 4	Optional, Code 8	AgNi + 0,2 μ Au AgNi + 10 μ Au
Rated current	6 A		
Switch-on current max. (20 ms)	15 A		
Switching voltage max.	250 V		
AC load (Fig 1)	1,5 kVA		
DC load	see Fig. 2		

Coil	
Coil resistance	see table; tolerance ± 10 %
Pick-up voltage	≤ 0,8 x U _N
Release voltage	≥ 0,1 x U _N
Nominal power	250 mW

Coil table	VDC	Ω	mA
	6	140	43
	12	536	22
	24	2164	11
	48	8651	5,5

Insulation	Volt rms, 1 min
Contact open	1000 V
Contact/contact	2,5 kV
Contact/coil	2,5 kV
Insulation resistance at 500 V	≥1 GΩ
Insulation, IEC 61810-1	2,5 kV/3

Specifications	
Ambient temperature operation/storage	-40 (no ice)...60 °C / -40 ... 80 °C
Pick-up time/bounce time	18 ms/≤ 3 ms
Release time/bounce time	10 ms/≤ 1 ms
Mechanical life ops	DC: 20 Mill.
DC voltage endurance at rated load	≥100000 switching cycles
Switching frequency at rated load	≤ 1200/ops/h
Protection class	IP40
Weight	73 g

Standard types		
VDC 12, 24, 48	C3-S14/DC ... V	C3-S18/DC ... V
Free wheeling diode	C3-S14D/DC ... V	C3-S18D/DC ... V
Polarity and free wheeling diode	C3-S14F/DC ... V	C3-S18F/DC ... V

Connection of diodes to the coil will increase the release time.
LED available upon request.

"..." Enter the voltage for full type designation

Accessories	
Socket:	S3-B, S3-S, S3-L, S3-P, S3-P0, S3-MP, S3-MS
Optional accessories (blanking plug):	SO-NP, SO-OP



Connection diagram

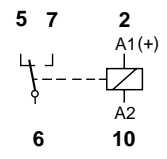


Fig. 1 AC voltage endurance

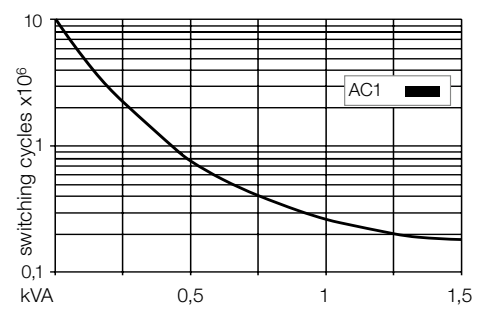
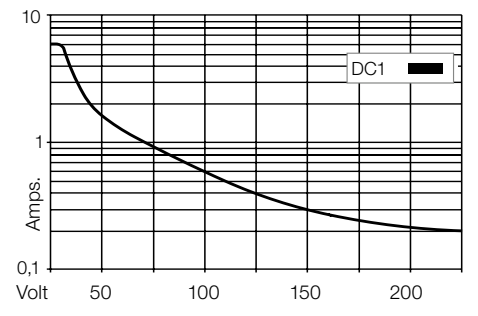
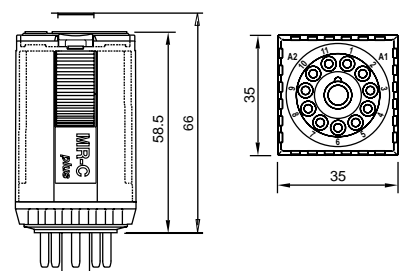


Fig. 2 DC load limit curve



Dimensions [mm]



Technical approvals, conformities



IEC 61810; EN 60947

Type	C3-E2x/ DC... V Sensitive relays, 500 mW, 2 change-over contacts			
Operating range	0,8 ... 1,7 x Un			
Maximum contact load	6 A/250 V	AC1	6 A/30 V	DC1
Recommended minimum contact load	10 mA/10 V	Code 4		
	5 mA/5 V	Code 8		

Contacts				
Material	Standard,	Code 4	AgNi + 0,2 μ Au	
	Optional,	Code 8	AgNi + 10 μ Au	
Rated current	6 A			
Switch-on current max. (20 ms)	15 A			
Switching voltage max.	250 V			
AC load (Fig 1)	1,5 kVA			
DC load	see Fig. 2			

Coil	
Coil resistance	see table; tolerance ± 10 %
Pick-up voltage	≤ 0,8 x U _N
Release voltage	≥ 0,1 x U _N
Nominal power	500 mW

Coil table																
	<table border="1"> <thead> <tr> <th>VDC</th> <th>Ω</th> <th>mA</th> </tr> </thead> <tbody> <tr> <td>24</td> <td>1K1</td> <td>21</td> </tr> <tr> <td>48</td> <td>4K6</td> <td>10</td> </tr> <tr> <td>60</td> <td>7K2</td> <td>8,3</td> </tr> <tr> <td>110</td> <td>24K2</td> <td>4,5</td> </tr> </tbody> </table>	VDC	Ω	mA	24	1K1	21	48	4K6	10	60	7K2	8,3	110	24K2	4,5
VDC	Ω	mA														
24	1K1	21														
48	4K6	10														
60	7K2	8,3														
110	24K2	4,5														

Insulation	Volt rms, 1 min
Contact open	1000 V
Contact/contact	2,5 kV
Contact/coil	2,5 kV
Insulation resistance at 500 V	≥ 1 GΩ
Insulation, IEC 61810-1	2,5 kV/3

Specifications	
Ambient temperature operation/storage	-40 (no ice)...60 °C /-40 ... 80 °C
Pick-up time/bounce time	18 ms/≤ 3 ms
Release time/bounce time	10 ms/≤ 1 ms
Mechanical life ops	DC: 20 Mill.
DC voltage endurance at rated load	≥ 100000 switching cycles
Switching frequency at rated load	≤ 1200/ops/h
Protection class	IP40
Weight	90 g

Standard types

VDC 24, 48, 60, 110	C3-E24/DC ... V	C3-E28/DC ... V
Free wheeling diode	C3-E24D/DC ... V	C3-E28D/DC ... V
Polarity and free wheeling diode	C3-E24F/DC ... V	C3-E28F/DC ... V

Connection of diodes to the coil will increase the release time.
LED available upon request.

"..." Enter the voltage for full type designation

Accessories

Socket:	S3-B, S3-S, S3-L, S3-P, S3-P0, S3-MP, S3-MS
Optional accessories (blanking plug):	SO-NP, SO-OP



Connection diagram

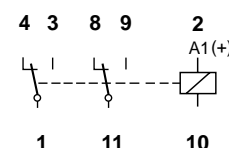


Fig. 1 AC voltage endurance

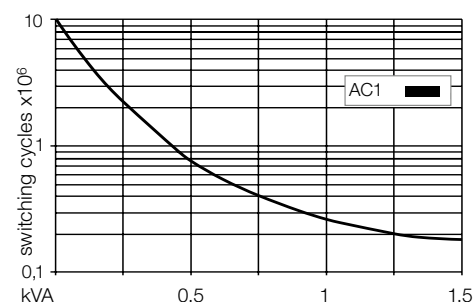
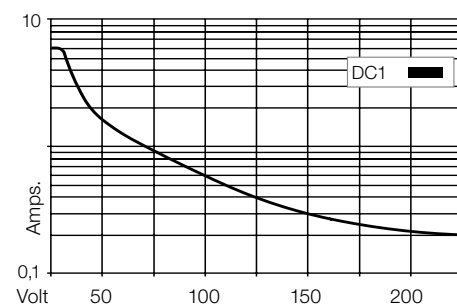
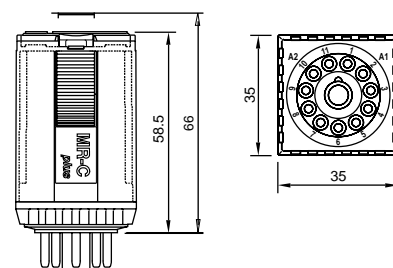


Fig. 2 DC load limit curve



Dimensions [mm]



Technical approvals, conformities



IEC 61810; EN 60947

Type	C3-N3x/DC ... V Sensitive relays, 800 mw 3 change-over contacts		
Operating range	0,8 ... 1,4 x Un		
Maximum contact load	6 A/250 V AC 1	6 A/30 V DC1	
Recommended minimum contact load	10 mA/10 V Code 4	5 mA/ 5 V Code 8	

Contacts			
Material	Standard	Code 4	AgNi + 0,2 μ Au
	Optional	Code 8	AgNi + 10 μ Au
Rated current	6 A		
Switch-on current max. (20 ms)	15 A		
Switching voltage max.	250 V		
AC load (Fig 1)	1,5 kVA		
DC load	see Fig. 2		

Coil	
Coil resistance	see table; tolerance ± 10 %
Pick-up voltage	≤ 0,8 x U _N
Release voltage	≥ 0,1 x U _N
Nominal power	800 mW

Coil table																
	<table border="1"> <thead> <tr> <th>VDC</th> <th>Ω</th> <th>mA</th> </tr> </thead> <tbody> <tr> <td>24</td> <td>720</td> <td>33</td> </tr> <tr> <td>48</td> <td>2K8</td> <td>17</td> </tr> <tr> <td>60</td> <td>4K5</td> <td>13</td> </tr> <tr> <td>110</td> <td>15K</td> <td>7</td> </tr> </tbody> </table>	VDC	Ω	mA	24	720	33	48	2K8	17	60	4K5	13	110	15K	7
VDC	Ω	mA														
24	720	33														
48	2K8	17														
60	4K5	13														
110	15K	7														

Insulation	Volt rms, 1 min
Contact open	1000 V
Contact/contact	2,5 kV
Contact/coil	2,5 kV
Insulation resistance at 500 V	≥1 GΩ
Insulation, IEC 61810-5	2,5 kV/3

Specifications	
Ambient temperature operation/storage	-40 (no ice)...60 °C /-40 ... 80 °C
Pick-up time/bounce time	18 ms/≤ 3 ms
Release time/bounce time	10 ms/≤ 1 ms
Mechanical life ops	DC: 20 Mill.
DC voltage endurance at rated load	≥100000 switching cycles
Switching frequency at rated load	≤ 1200/ops/h
Protection class	IP40
Weight	90 g

Standard types	
VDC 24, 48, 60, 110	
Free wheeling diode	C3-N34/DC ... V C3-N38/DC ... V
Polarity and free wheeling diode	C3-N34D/DC ... V C3-N38D/DC ... V
	C3-N34F/DC ... V C3-N38F/DC ... V

Connection of diodes to the coil will increase the release time.
LED available upon request.

"..." Enter the voltage for full type designation

Accessories	
Socket:	S3-B, S3-S, S3-L, S3-P, S3-P0, S3-MP, S3-MS
Optional accessories (blanking plug):	SO-NP, SO-OP



Connection diagram

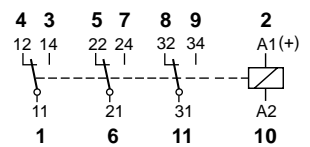


Fig. 1 AC voltage endurance

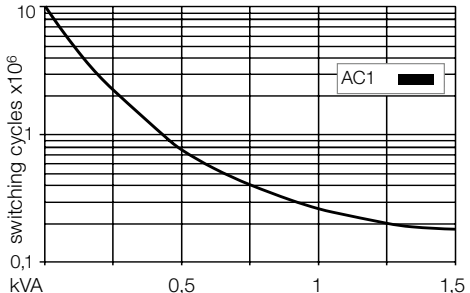
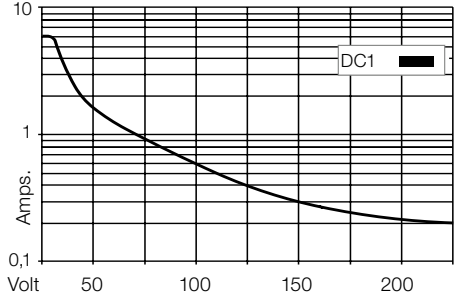
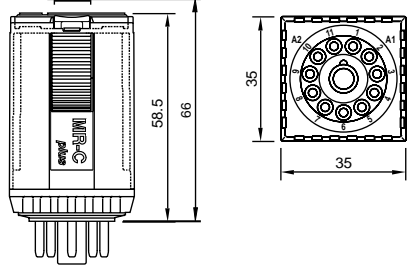


Fig. 2 DC load limit curve



Dimensions [mm]



Technical approvals, conformities



IEC 61810; EN 60947

R3-N3xD

11-pin, special relay, 3-pole, according to IEC 67-I-18a
 Relay approval: EN 60077-1-2/99 - EN 61373/99 for Railway application

Type	R3-NxD/ ... V Relays for Railway application 3 change-over contacts special wide range voltage
-------------	--

Maximum contact load	6 A 250 V AC1	6 A 30 V DC1
Recommended minimum contact load	10 mA/10 V Code 0, 4 5 mA/5 V Code 8	

Contacts

Material	Standard	Code 0	AgNi
	Optional	Code 4	AgNi + 0,2µ Au
	Optional	Code 8	AgNi + 10µ Au
Rated current	6 A		
Switch-on current max. (20 ms)	15 A		
Switching voltage max.	250 V		
Max. AC load	see Fig. 1		
DC load	see Fig. 2		

Coil

Coil resistance	see table; tolerance ± 10 %
Operation range	0,7 U _N ... 1,25 U _N
Nominal power	1,07 W

Coil table

VDC	Ω	mA
24	525	46
48	2133	22
72	4844	15
110	12900	9

Insulation

Pollution grade	PD3
With pulse (1,2 / 50 µs)/Dielectric strength (1Minute/V rms)	
Contact/coil	4 kV / 2220 V
Contact/contact	4 kV / 2220 V
Between contact and the same pole	1550 kV / 850 V

Specifications

Ambient temperature operation/storage	-25 (no ice)...70 °C / -40 ... 80 °C
Number of mechanical operations	≥ 10 millions
Thermic class	B (130 °C)
Vibration : category / class	1 / B Body mounted
	5 - 150 Hz (3 axes)
Shock	5 g (3 axes)
Pick-up time/bounce time	18 ms/≤ 3 ms
Release time/bounce time (D version)	35 ms/≤ 1 ms
Weight	95 g
Weight avg. Relay + Socket (S3-B)	150 g
Protection class	IP 40

Standard types

DC 24, 48, 72, 110

Free wheeling diode

LED

LED + free wheeling diode

R3-N30/DC ... V	R3-N34/DC ... V	R3-N38/DC ... V
R3-N30D/DC ... V	R3-N34D/DC ... V	R3-N38D/DC ... V
R3-N30X/DC ... V	R3-N34X/DC ... V	R3-N38X/DC ... V
R3-N30DX/DC ... V	R3-N34DX/DC ... V	R3-N38DX/DC ... V*

"..." Enter the voltage for full type designation

Accessories

Socket:	S3-B, S3-S, S3-L, S3-P, S3-P0, S3-MP, S3-MS
Optional accessories (blanking plug):	SO-NP, SO-OP



Connection diagram

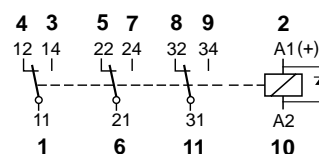


Fig. 1 AC voltage endurance

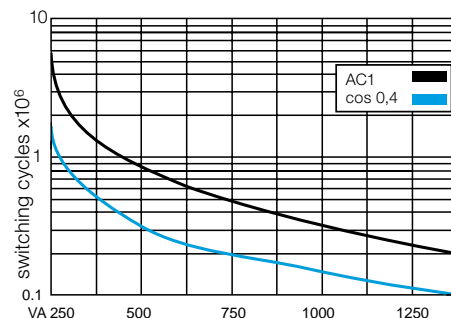
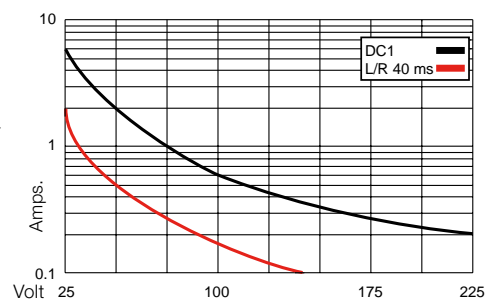
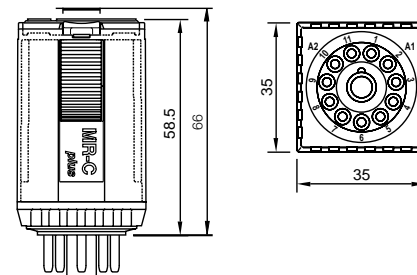


Fig. 2 DC load limit curve



Dimensions [mm]



Technical approvals, conformities



IEC 60077/EN60077-1-2/99; EN61373/99

C4-A4x

14-pin, **standard relay, 4-pole, plug-in, faston**

Type	C4-A4x/ ... V Standard relays, 4 change-over contacts			
Maximum contact load	10 A/250 V AC1	0,5 A/110 V DC1		
	10 A/30 V DC1	0,2 A/220 V DC1		
Recommended minimum contact load	10 mA/10 V Code 0, 9			
	5 mA/5 V Code 8			

Contacts			
Material	Standard	Code 0	AgNi
	Optional	Code 8	AgNi + 10 μ Au
	Optional	Code 9	AgNi + 0,2 μ Au
Rated current	10 A		
Switch-on current max. (20 ms)	30 A		
Switching voltage max.	250 V		
AC load (Fig 1)	2,5 kVA		
DC load	see Fig. 2		

Coil	
Coil resistance	see table; tolerance ± 10 %
Pick-up voltage	≤ 0,8 × U _N
Release voltage	≥ 0,1 × U _N
Nominal power	2,4 VA (AC)/1,4 W (DC)

Coil table					
VAC	Ω	mA	VDC	Ω	mA
24	65	100	24	414	58
48	286	50	48	1K6	30
115	1K7	21	110	8K1	13
230	6K8	10	220	35K7	6,2

Insulation	Volt rms, 1 min
Contact open	1000 V
Contact/contact	2,5 kV
Contact/coil	2,5 kV
Insulation resistance at 500 V	≥ 1 GΩ
Insulation, IEC 61810-1	2,5 kV/3

Specifications	
Ambient temperature operation/storage	-40 (no ice)...60 °C / -40 ... 80 °C
Pick-up time/bounce time	20 ms/≤ 3 ms
Release time/bounce time	8 ms/≤ 1 ms
Mechanical life ops	AC: 10 Mill./DC: 20 Mill.
DC voltage endurance at rated load	≥ 100000 switching cycles
Switching frequency at rated load	≤ 1200/ops/h
Protection class	IP40
Weight	90 g

Standard types		
VAC 50 Hz/60 Hz: 24, 48, 115, (120), 230, (240)	C4-A40/AC ... V	C4-A48/AC ... V
LED	C4-A40X/AC ... V	C4-A48X/AC ... V
RC suppressor	C4-A40R/AC ... V	C4-A48R/AC ... V
VDC 24, 48, 110, 220	C4-A40/DC ... V	C4-A48/DC ... V
LED	C4-A40X/DC ... V	C4-A48X/DC ... V
Free wheeling diode	C4-A40DX/DC ... V	C4-A48DX/DC ... V
Polarity and free wheeling diode	C4-A40FX/DC ... V	C4-A48FX/DC ... V
AC/DC bridge rectifier 24 V, 48 V, 60 V	C4-A40BX/UC ... V	C4-A48BX/UC ... V

"..." Enter the voltage for full type designation

Accessories	
Socket:	S4-J, S4-L, S4-P, S4-PO
Optional accessories (blanking plug):	SO-NP, SO-OP



Connection diagram

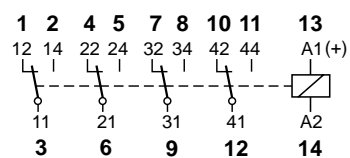


Fig. 1 AC voltage endurance

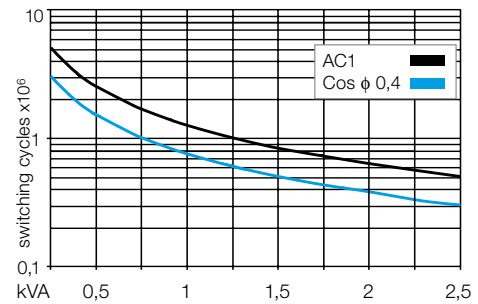
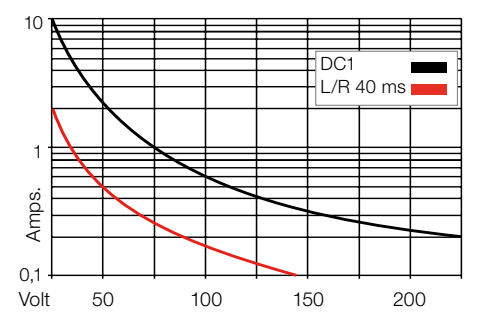
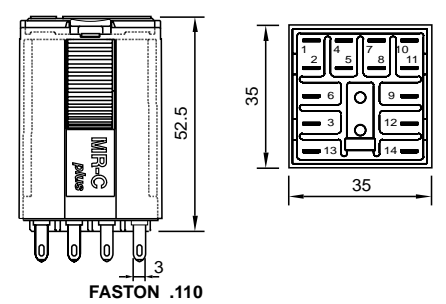


Fig. 2 DC load limit curve



Dimensions [mm]



Technical approvals, conformities



IEC 61810; EN 60947

Type	C4-X2x/ ... V Power relays, DC application 2-pole, NO, double make			
-------------	---	--	--	--

Maximum contact load	10 A/250 V AC 1	7 A/110 V DC 1
	10 A/30 V DC 1	1,2 A/220 V DC 1

Contacts

Material	Standard	Code 0	AgNi
Rated current			10 A
Switch-on current max. (20 ms)			30 A
Switching voltage max			250 V
AC load (Fig 1)			2,5 kVA
DC load			see Fig. 2

Coil

Coil resistance	see table; tolerance ± 10 %
Pick-up voltage	≤ 0,8 × U _N
Release voltage	≥ 0,1 × U _N
Nominal power	2,4 VA (AC)/1,3 W (DC)

Coil table

VAC	Ω	mA	VDC	Ω	mA
24	65	100	24	443	54
48	286	50	48	1K8	27
115	1K7	21	110	9K2	12
230	6k8	10	220	36K1	6

Insulation

	Volt rms, 1 min
Contact open	2500 V
Contact/contact	2,5 kV
Contact/coil	2,5 kV
Insulation resistance at 500 V	≥ 1 G.Ω
Insulation, IEC 61810-1	2,5 kV/3

Specifications

Ambient temperature operation/storage	-40 (no ice)...60 °C / -40 ... 80 °C
Pick-up time/bounce time	20 ms/≤ 3 ms
Release time/bounce time	8 ms/≤ 1 ms
Mechanical life ops	AC: 10 Mill./DC: 20 Mill.
DC voltage endurance at rated load	≥ 100000 switching cycles
Switching frequency at rated load	≤ 1200/ops/h
Protection class	IP40
Weight	90 g

Standard types

VAC 50 Hz/60 Hz: 24, 48, 115, (120), 230, (240)

LED

RC Suppressor

VDC 24, 48, 110, 220

LED

Free wheeling diode

Polarity and free wheeling diode

AC/DC bridge rectifier 24 V, 48 V, 60 V

C4-X20/AC ... V

C4-X20X/AC ... V

C4-X20R/AC ... V

C4-X20/DC ... V

C4-X20X/DC ... V

C4-X20DX/DC ... V

C4-X20FX/DC ... V

C4-X20BX/UC ... V

"..." Enter the voltage for full type designation

Accessories

Socket:	S4-S, S4-L, S4-P, S4-P0
Optional accessories (blanking plug):	SO-NP, SO-OP



Connection diagram

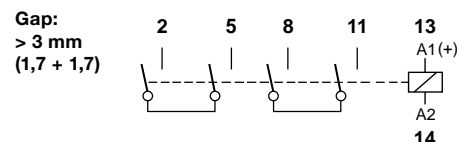


Fig. 1 AC voltage endurance

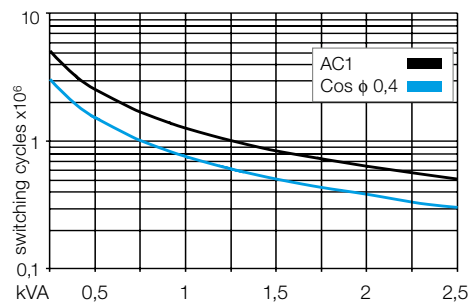
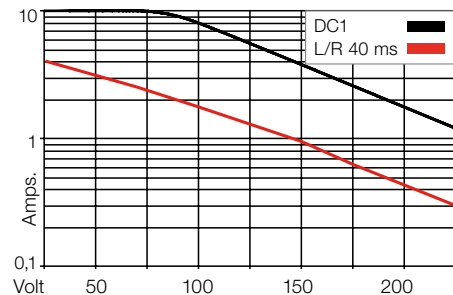
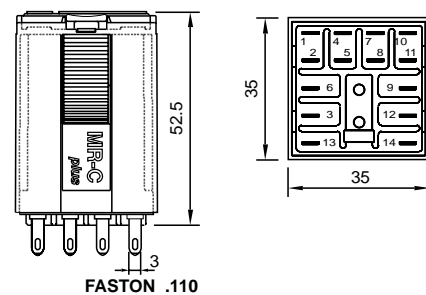


Fig. 2 DC load limit curve



Dimensions [mm]



Technical approvals, conformities



IEC 61810; EN 60947

C4-R3x

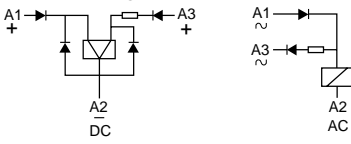
14-pin, remanence relay, 3-pole, faston

Type	C4-R3x/ ... V Magnetic remanence relay 3 change-over contact			
Maximum contact load	10 A/250 V AC 1	0,5 A/110 V DC1		
	10 A/10 V DC 1	0,2 A/220 V DC1		
Recommended minimum contact load	10 mA/10 V Code 0, 9			
	5 mA/5 V Code 8			

Contacts			
Material	Standard	Code 0	AgNi
	Optional	Code 8	AgNi + 10 μ Au
	Optional	Code 9	AgNi + 0,2 μ Au
Rated current	10 A		
Switch-on current max. (20 ms)	30 A		
Switching voltage max.	250 V		
AC load	2,5 kVA		
DC load	see Fig. 2		

Coil	
Coil resistance	see table; tolerance ± 10 %
ON pulse power	1,5 VA/W
OFF pulse power	0,5 VA/W
Pull-in ON/OFF	1 Winding for AC, 2 Windings for DC ≤ 0,8 x U _N

Internal Diagram:



Coil table

VAC	mA ON	mA OFF	VDC	mA ON	mA OFF
24	75	12	12	125	41
48	38	6	24	63	21
115	16	2,5	48	31	10
230	8	1,3	110	14	4,5

Insulation	
Contact open	Volt rms, 1 min 1000 V
Contact/contact	2,5 kV
Contact/coil	2,5 kV
Insulation resistance at 500 V	≥1 GΩ
Insulation, IEC 61810-1	2,5 kV/3

Specifications	
Ambient temperature operation/storage	-40 (no ice)...60 °C / -40 ... 80 °C
Minimum pulse length for ON/OFF	50 ms
Mechanical life ops	AC: 10 Mill./DC: 20 Mill. switching cycles
DC voltage endurance at rated load	≥100000 switching cycles
Switching frequency at rated load	≤ 1200/h
Protection class	IP40
Weight	95 g

Standard types
VAC 50 Hz/60 Hz: 24, 48, 115 (120), 230 (240)

VDC 12, 24, 48, 110

C4-R30/AC ... V	C4-R38/AC ... V	C4-R39/AC ... V
C4-R30/DC ... V	C4-R38/DC ... V	C4-R39/DC ... V

"..." Enter the voltage for full type designation

Accessories	
Socket:	S4-J, S4-L, S4-P, S4-P0
Optional accessories (blanking plug):	SO-NP, SO-OP



Connection diagram

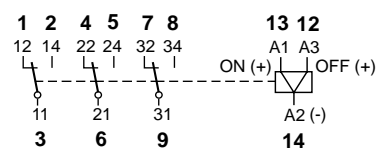


Fig. 1 AC voltage endurance

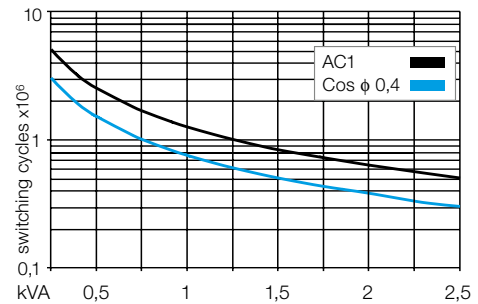
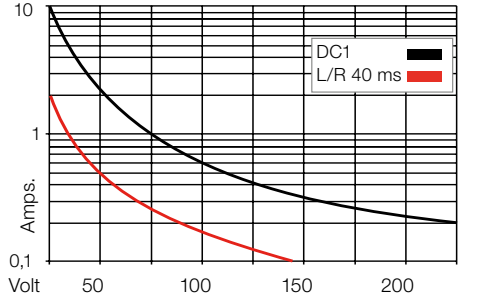
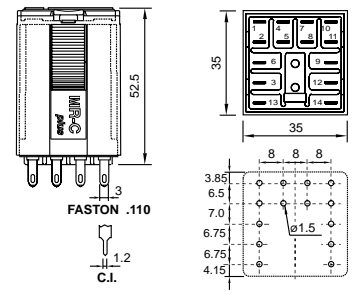


Fig. 2 DC load limit curve



Dimensions [mm]



Technical approvals, conformities



IEC 61810; EN 60947

Type	C5-A2x/ ... V Power relays, 2 change-over contacts		
Maximum contact load	16 A/400 V AC1 16 A/30 V DC1	0,5 A/110 V DC1	0,2 A/220 V DC1
Contacts	Material Standard Code 0 AgNi Rated current 16 A Switch-on current max. (20 ms) 40 A Switching voltage max. 400 V AC load (Fig 1) 4 kVA DC load see Fig. 2		

Coil	see table; tolerance ± 10 %
Coil resistance	≤ 0,8 × U _N
Pick-up voltage	≥ 0,1 × U _N
Release voltage	2,4 VA (AC)/1,4 W (DC)
Nominal power	

Coil table	VAC	Ω	mA	VDC	Ω	mA
	24	65	100	24	414	58
	48	286	50	48	1K6	30
	115	1K7	21	110	8K1	13
	230	6K8	10	220	35K6	6
	400	18K8	6			

Insulation	Volt rms, 1 min
Contact open	1000 V
Contact/contact	4 kV
Contact/coil	4 kV
Insulation resistance at 500 V	≥ 3 GΩ
Insulation, IEC 61810-1	4 kV/3

Specifications	
Ambient temperature operation/storage	-40 (no ice)...60 °C / -40 ... 80 °C
Pick-up time/bounce time	20 ms/≤ 3 ms
Release time/bounce time	10 ms/≤ 1 ms
Mechanical life ops	AC: 10 Mill./DC: 20 Mill.
DC voltage endurance at rated load	≥ 100000 switching cycles
Switching frequency at rated load	≤ 1200/ops/h
Protection class	IP40
Weight	90 g

Standard types	C5-A20/AC ... V
VAC 50 Hz/60 Hz: 24, 48, 115 (120), 230 (240)	C5-A20X/AC ... V
LED	C5-A20R/AC ... V
RC suppressor (max 250 V)	C5-A20/DC ... V
	C5-A20X/DC ... V
VDC 24, 48, 110, 220	C5-A20DX/DC ... V
LED	C5-A20FX/DC ... V
Free wheeling diode	C5-A20BX/UC ... V
Polarity and free wheeling diode	
AC/DC bridge rectifier 24 V, 48 V, 60 V	

"..." Enter the voltage for full type designation

Accessories	
Socket:	S5-S, S5-L, S5-P, S5-P0, S5-M
Optional accessories (blanking plug):	SO-NP, SO-OP



Connection diagram

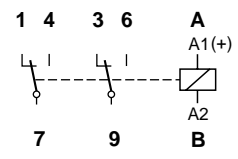


Fig. 1 AC voltage endurance

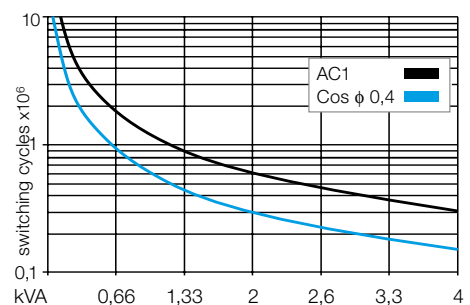
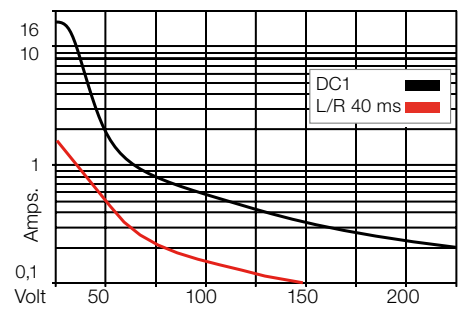
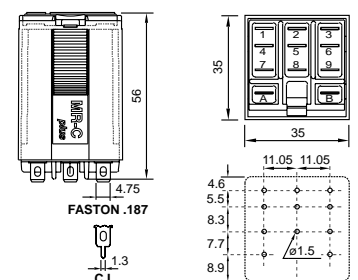


Fig. 2 DC load limit curve



Dimensions [mm]



Technical approvals, conformities



IEC 61810; EN 60947

C5-A3x

11-pin, **power relay, 3-pole, plug-in, faston**

Type	C5-A3x/ ... V Power relays, 3 change-over contacts		
Maximum contact load	16 A/400 V AC1	0,5 A/110 V DC1	
	16 A/30 V DC1	0,2 A/220 V DC1	
Contacts			
Material	Standard	Code 0	AgNi
Rated current	16 A		
Switch-on current max. (20 ms)	40 A		
Switching voltage max.	400 V		
AC load (Fig 1)	4 kVA		
DC load	see Fig. 2		

Coil			
Coil resistance	see table; tolerance $\pm 10\%$		
Pick-up voltage	$\leq 0,8 \times U_N$		
Release voltage	$\geq 0,1 \times U_N$		
Nominal power	2,4 VA (AC)/1,4 W (DC)		

Coil table	VAC	Ω	mA	VDC	Ω	mA
	24	65	100	24	414	58
	48	286	50	48	1K6	30
	115	1K7	21	110	8K1	13
	230	6K8	10	220	35K6	6,2
	400	18K8	6			

Insulation		Volt rms, 1 min
Contact open	1000 V	
Contact/contact	4 kV	
Contact/coil	4 kV	
Insulation resistance at 500 V	$\geq 3 \text{ G}\Omega$	
Insulation, IEC 61810-1	4 kV/3	

Specifications	
Ambient temperature operation/storage	-40 (no ice)...60 °C / -40 ... 80 °C
Pick-up time/bounce time	20 ms/ ≤ 3 ms
Release time/bounce time	10 ms/ ≤ 1 ms
Mechanical life ops	AC: 10 Mill./DC: 20 Mill.
DC voltage endurance at rated load	≥ 100000 switching cycles
Switching frequency at rated load	≤ 1200 /h
Protection class	IP40
Weight	95 g

Standard types	
VAC 50 Hz/60 Hz: 24, 48, 115, (120), 230, (240)	C5-A30/AC ... V
LED	C5-A30X/AC ... V
RC suppressor (max 250 V)	C5-A30R/AC ... V
VDC 24, 48, 110, 220	C5-A30/DC ... V
LED	C5-A30X/DC ... V
Free wheeling diode	C5-A30DX/DC ... V
Polarity and free wheeling diode	C5-A30FX/DC ... V
AC/DC bridge rectifier 24 V, 48 V, 60 V	C5-A30BX/UC ... V

"..." Enter the voltage for full type designation

Accessories	
Socket:	S5-S, S5-L, S5-P, S5-P0, S5-M
Optional accessories (blanking plug):	SO-NP, SO-OP



Connection diagram

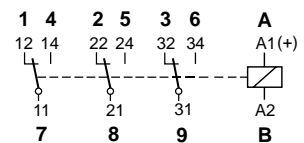


Fig. 1 AC voltage endurance

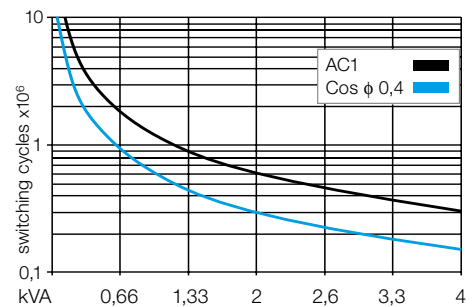
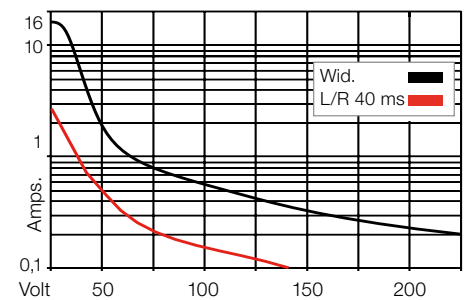
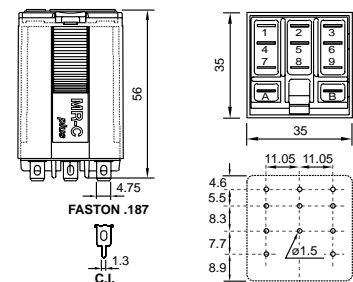


Fig. 2 DC load limit curve



Dimensions [mm]



Technical approvals, conformities



EN 60947; IEC 61810

Type	C5-G3x/ ... V Power relays, DC application. 3 open contacts		
-------------	--	--	--

Maximum contact load	16 A/400 V AC1	1,2 A/110 V DC1
	16 A/30 V DC1	0,4 A/220 V DC1

Contacts

Material	Standard	Code 0	AgNi
Rated current			16 A
Switch-on current max. (20 ms)			40 A
Switching voltage max.			400 V
AC load (Fig 1)			4 kVA
DC load			see Fig. 2

Coil

Coil resistance	see table; tolerance $\pm 10\%$
Pick-up voltage	$\leq 0,8 \times U_N$
Release voltage	$\geq 0,1 \times U_N$
Nominal power	2,4 VA (AC)/1,6 W (DC)

Coil table

VAC	Ω	mA	VDC	Ω	mA
24	65	100	12	90	133
48	286	50	24	373	66
115	1K7	21	48	1K4	34
230	6K8	10	110	7K6	15
400	18K8	6	220	30K3	7,5

Insulation

	Volt rms, 1 min
Contact open	2000 V
Contact/contact	4 kV
Contact/coil	4 kV
Insulation resistance at 500 V	$\geq 3 \text{ G}\Omega$
Insulation, IEC 61810-1	4 kV/3

Specifications

Ambient temperature operation/storage	-40 (no ice)...60 °C / -40 ... 80 °C
Pick-up time/bounce time	20 ms/ ≤ 3 ms
Release time/bounce time	10 ms/ ≤ 1 ms
Mechanical life ops	AC: 10 Mill./DC: 20 Mill.
DC voltage endurance at rated load	≥ 100000 switching cycles
Switching frequency at rated load	≤ 1200 /h
Protection class	IP40
Weight	95 g

Standard types

VAC 50 Hz/60 Hz: 24, 48, 115, (120), 230, (240)

LED

RC suppressor (max 250 V)

VDC 12, 24, 48, 110, 220

LED

Free wheeling diode

Polarity and free wheeling diode

AC/DC bridge rectifier 24 V, 48 V, 60 V

C5-G30/AC ... V

C5-G30X/AC ... V

C5-G30R/AC ... V

C5-G30/DC ... V

C5-G30X/DC ... V

C5-G30DX/DC ... V

C5-G30FX/DC ... V

C5-G30BX/UC ... V

"..." Enter the voltage for full type designation

Accessories

Socket:	S5-S, S5-L, S5-P, S5-P0, S5-M
Optional accessories (blanking plug):	SO-NP, SO-OP



Connection diagram

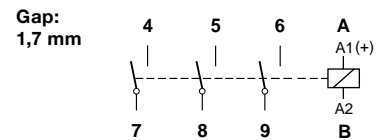


Fig. 1 AC voltage endurance

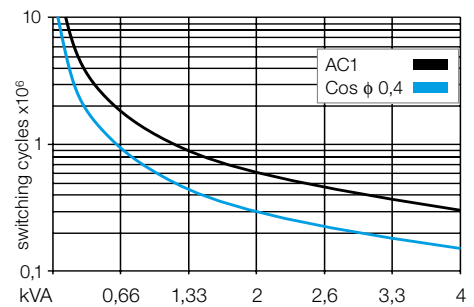
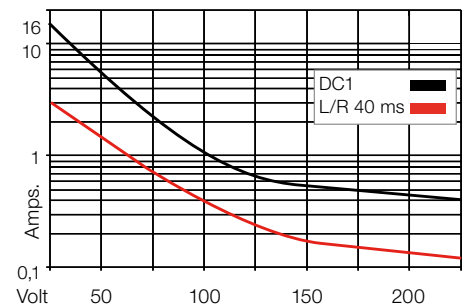
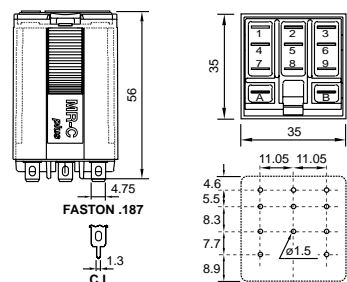


Fig. 2 DC load limit curve



Dimensions [mm]



Technical approvals, conformities



EN 60947; IEC 61810

C5-X1x

4-pin, power relay, 1-pole, double make, faston

Type	C5-X1x/ ... V Power relays, DC application 1 pole, NO, double make		
Maximum contact load	16 A/400 V AC1 16 A/30 V DC1		7 A/110 V DC1 1,2 A/220V DC13

Contacts			
Material	Standard	Code 0	AgNi
Rated current			16 A
Switch-on current max. (20 ms)			40 A
Switching voltage max.			400 V
AC load (Fig 1)			4 kVA
DC load			see Fig. 2

Coil	
Coil resistance	see table; tolerance ± 10 %
Pick-up voltage	≤ 0,8 × U _N
Release voltage	≥ 0,1 × U _N
Nominal power	2,4 VA (AC)/1,3 W (DC)

Coil table																																					
	<table border="1"> <thead> <tr> <th>VAC</th> <th>Ω</th> <th>mA</th> <th>VDC</th> <th>Ω</th> <th>mA</th> </tr> </thead> <tbody> <tr> <td>24</td> <td>65</td> <td>100</td> <td>12</td> <td>110</td> <td>108</td> </tr> <tr> <td>48</td> <td>286</td> <td>50</td> <td>24</td> <td>443</td> <td>54</td> </tr> <tr> <td>115</td> <td>1K7</td> <td>21</td> <td>48</td> <td>1K7</td> <td>27</td> </tr> <tr> <td>230</td> <td>6K8</td> <td>10</td> <td>110</td> <td>9K2</td> <td>12</td> </tr> <tr> <td>400</td> <td>18K8</td> <td>6</td> <td>220</td> <td>34K5</td> <td>6,2</td> </tr> </tbody> </table>	VAC	Ω	mA	VDC	Ω	mA	24	65	100	12	110	108	48	286	50	24	443	54	115	1K7	21	48	1K7	27	230	6K8	10	110	9K2	12	400	18K8	6	220	34K5	6,2
VAC	Ω	mA	VDC	Ω	mA																																
24	65	100	12	110	108																																
48	286	50	24	443	54																																
115	1K7	21	48	1K7	27																																
230	6K8	10	110	9K2	12																																
400	18K8	6	220	34K5	6,2																																

Insulation	Volt rms, 1 min
Contact open	4 kV
Contact/contact	4 kV
Contact/coil	4 kV
Insulation resistance at 500 V	≥ 3 GΩ
Insulation, IEC 61810-1	4 kV/3

Specifications	
Ambient temperature operation/storage	-40 (no ice)...60 °C /-40 ... 80 °C
Pick-up time/bounce time	20 ms/≤ 3 ms
Release time/bounce time	10 ms/≤ 1 ms
Mechanical life ops	AC: 10 Mill./DC: 20 Mill.
DC voltage endurance at rated load	≥100000 switching cycles
Switching frequency at rated load	≤ 1200/h
Protection class	IP40
Weight	90 g

Standard types	
VAC 50 Hz/60 Hz: 24, 48, 115 (120), 230 (240)	C5-X10/AC ... V
LED	C5-X10X/AC ... V
RC suppressor (max 250 V)	C5-X10R/AC ... V
VDC 12, 24, 48, 110, 220	C5-X10/DC ... V
LED	C5-X10X/DC ... V
Free wheeling diode	C5-X10DX/DC ... V
Polarity and free wheeling diode	C5-X10FX/DC ... V
AC/DC bridge rectifier 24 V, 48 V, 60 V	C5-X10BX/UC ... V

"..." Enter the voltage for full type designation

Accessories	
Socket:	S5-S, S5-L, S5-P, S5-P0, S5-M
Optional accessories (blanking plug):	SO-NP, SO-OP



Connection diagram

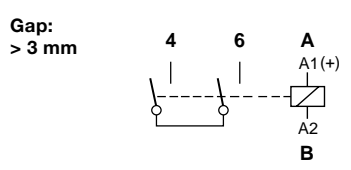


Fig. 1 AC voltage endurance

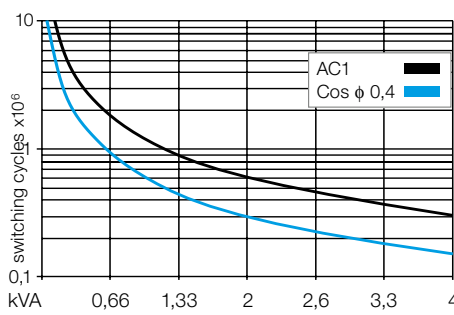
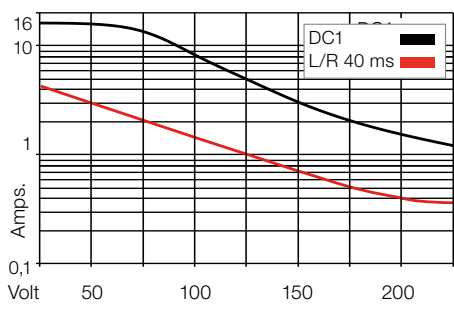
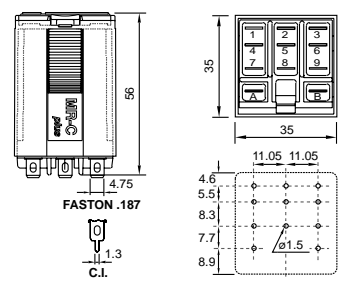


Fig. 2 DC load limit curve



Dimensions [mm]



Technical approvals, conformities



IEC 61810; EN 60947

Type	C5-M1x/ ... V Power relays, DC application 1 pole, NO, magnetic blow out
-------------	---

Maximum contact load	16 A/400 V AC1 10 A/220 V DC1 3,6 A/110 V DC13 2 A/220 V DC13
-----------------------------	--

Contacts			
Material	Standard	Code 0	AgNi
Rated current			16 A
Switch-on current max. (20 ms)			40 A
Switching voltage max.			400 V
AC load (Fig 1)			4 kVA
DC load			see Fig. 2

Coil	
Coil resistance	see table; tolerance ± 10 %
Pick-up voltage	≤ 0,8 × U _N
Release voltage	≥ 0,1 × U _N
Nominal power	2,4 VA (AC)/1,3 W (DC)

Coil table																																					
	<table border="1"> <thead> <tr> <th>VAC</th> <th>Ω</th> <th>mA</th> <th>VDC</th> <th>Ω</th> <th>mA</th> </tr> </thead> <tbody> <tr> <td>24</td> <td>65</td> <td>100</td> <td>12</td> <td>110</td> <td>108</td> </tr> <tr> <td>48</td> <td>286</td> <td>50</td> <td>24</td> <td>443</td> <td>54</td> </tr> <tr> <td>115</td> <td>1K7</td> <td>21</td> <td>48</td> <td>1K7</td> <td>27</td> </tr> <tr> <td>230</td> <td>6K8</td> <td>10</td> <td>110</td> <td>9K2</td> <td>12</td> </tr> <tr> <td>400</td> <td>18K8</td> <td>6</td> <td>220</td> <td>34K5</td> <td>6,2</td> </tr> </tbody> </table>	VAC	Ω	mA	VDC	Ω	mA	24	65	100	12	110	108	48	286	50	24	443	54	115	1K7	21	48	1K7	27	230	6K8	10	110	9K2	12	400	18K8	6	220	34K5	6,2
VAC	Ω	mA	VDC	Ω	mA																																
24	65	100	12	110	108																																
48	286	50	24	443	54																																
115	1K7	21	48	1K7	27																																
230	6K8	10	110	9K2	12																																
400	18K8	6	220	34K5	6,2																																

Insulation	Volt rms, 1 min
Contact open	4000 V
Contact/contact	4 kV
Contact/coil	4 kV
Insulation resistance at 500 V	≥ 3 GΩ
Insulation, IEC 61810-1	4 kV/3

Specifications	
Ambient temperature operation/storage	-40 (no ice)...60 °C /-40 ... 80 °C
Pick-up time/bounce time	20 ms/≤ 3 ms
Release time/bounce time	10 ms/≤ 1 ms
Mechanical life ops	AC: 10 Mill./DC: 20 Mill.
DC voltage endurance	see fig. 2
Switching frequency at rated load	≤ 1200/h
Protection class	IP40
Weight	90 g

- Standard types**
- VAC 50 Hz/60 Hz: 24, 48, 115 (120), 230 (240)**
- LED**
- RC suppressor (max 250 V)**

- VDC 12, 24, 48, 110, 220**
- LED**
- Free wheeling diode**
- Polarity and free wheeling diode**

- AC/DC bridge rectifier 24 V, 48 V, 60 V**

- C5-M10/AC ... V**
- C5-M10X/AC ... V**
- C5-M10R/AC ... V**

- C5-M10/DC ... V**
- C5-M10X/DC ... V**
- C5-M10DX/DC ... V**
- C5-M10FX/DC ... V**

- C5-M10BX/UC ... V**

"..." Enter the voltage for full type designation

Accessories	
Socket:	S5-S, S5-L, S5-P, S5-P0, S5-M
Optional accessories (blanking plug):	SO-NP, SO-OP



Connection diagram

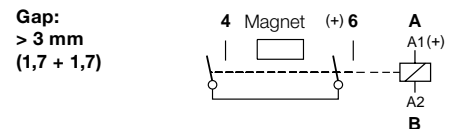


Fig. 1 AC voltage endurance

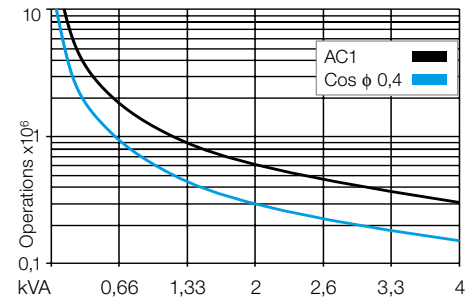
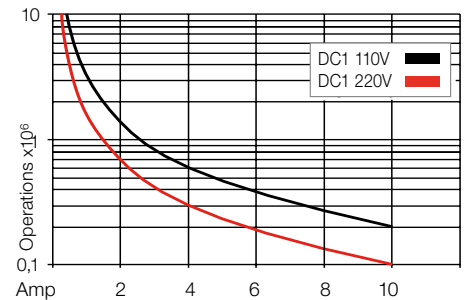
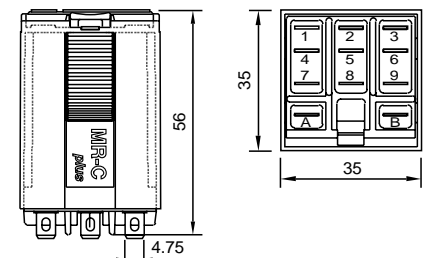


Fig. 2 DC voltage endurance



Dimensions [mm]



Technical approvals, conformities



IEC 61810; EN 60947

C5-M2x

6-pin, power relay, 2-pole normally open, magnetic blow out, faston

Type **C5-M2x/ ... V**
 Power relays, DC application
 double pole, NO, magnetic blow out

Maximum contact load **16 A @ 250 V AC1** **7 A @ 110 V DC1**
3 A @ 220 V DC1

Contacts
 Material Standard Code 0 AgNi
 Rated current 16 A
 Switch-on current max. (20 ms) 40 A
 Switching voltage max. 250 V
 AC load (Fig 1) 4 kVA
 DC load see Fig. 2

Coil
 Coil resistance see table; tolerance ± 10 %
 Pick-up voltage ≥ 0,8 x U_N
 Release voltage ≥ 0,1 x U_N
 Nominal power 2,4 VA (AC) / 1,6 W (DC)

Coil table

VAC	Ω	mA	VDC	Ω	mA
24	65	100	12	90	133
48	286	50	24	373	66
115	1K7	21	48	1K4	33
230	6K8	10.4	110	7K6	15

Insulation Volt rms, 1 min
 Contact open 2 kV
 Contact/contact 4 kV
 Contact/coil 3 kV
 Insulation resistance at 500 V ≥ 3 GΩ
 Insulation, EN 60947/IEC 61810-1: 4 KV/3

Specifications
 Ambient temperature operation/storage -40 (no ice)...60 °C / -40 ... 80 °C
 Pick-up time/bounce time 20 ms/≤ 3 ms
 Release time/bounce time 10 ms/≤ 1 ms
 Mechanical life ops AC: 10 Mill./DC: 20 Mill. switching cycles
 DC Rated load ≥ 75.000 switching cycles
 Switching frequency at rated load ≤ 1200/h
 Protection class IP40
 Weight 90 g

Standard types
VAC 50 Hz/60 Hz: 24, 48, 115 (120), 230 (240)
LED
RC suppresor (max 250 V)

VDC 12, 24, 48, 110, 220
LED
Free wheeling diode
Polarity and free wheeling diode

AC/DC bridge rectifier 24 V, 48 V, 60 V

- C5-M20/AC ... V
- C5-M20X/AC ... V
- C5-M20R/AC ... V
- C5-M20/DC ... V
- C5-M20X/DC ... V
- C5-M20DX/DC ... V
- C5-M20FX/DC ... V
- C5-M20BX/UC ... V

"..." Enter the voltage for full type designation

Accessories
 Socket: **S5-S, S5-L, S5-P, S5-P0, S5-M**
 Optional accessories (blanking plug): **SO-NP, SO-OP**



Connection diagram

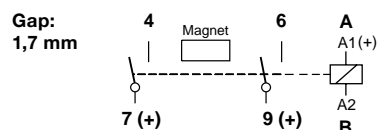


Fig. 1 AC voltage endurance

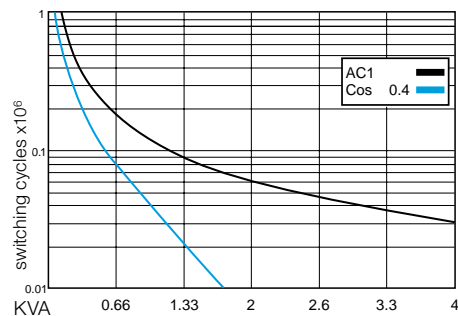
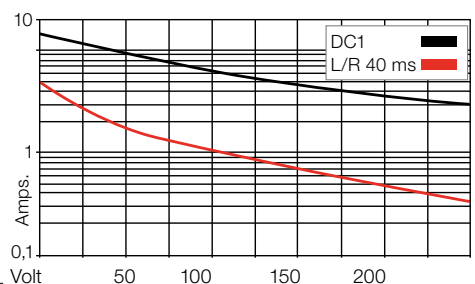
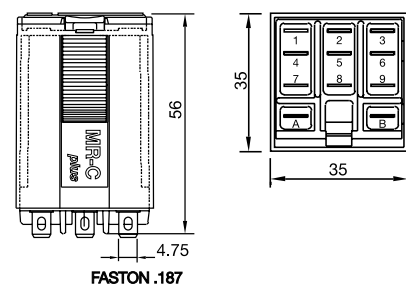


Fig. 2 DC load limit curve



Dimensions [mm]



Technical approvals, conformities



IEC 61810; EN 60947

Type **C5-R2x/ ... V**
 Magnetic latching – Remanence relays
 2 change-over contact, 10A

Maximum contact load **10 A/400 V AC1** **10 A/30 V DC1**
0,2 A/250 V DC1 **0,5 A/110 V DC1**

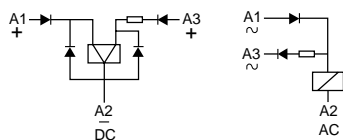
Contacts

Material Standard Code 0 AgNi
 Rated current 10 A
 Switch-on current max. (20 ms) 30 A
 Switching voltage max. 400 V
 AC load (Fig 1) 4 kVA
 DC load see Fig. 2

Coil

Coil resistance see table; tolerance ± 10 %
 ON pulse power 1,5 VA/W
 OFF pulse power 0,5 VA/W
 1 winding for AC, 2 winding for DC
 Pull-in ON/OFF < 0,8 x U_N

Internal Diagram:



Coil table

VAC	mA ON	mA OFF	VDC	mA ON	mA OFF
24	75	12	12	125	41
48	38	6	24	63	21
115	16	2,5	48	31	10
230	8	1,3	110	14	4,5

Insulation

Volt rms, 1 min
 Contact open 1000 V
 Contact/contact 4 kV
 Contact/coil 4 kV
 Insulation resistance at 500 V ≥3 GΩ
 Insulation, EN 60947/IEC 61810-1 4 kV/3

Specifications

Ambient temperature operation/storage -40 (no ice)...60 °C /-40 ... 80 °C
 Minimum pulse ON/OFF 50 ms
 Mechanical life ops AC: 10 Mill./DC: 20 Mill.
 DC voltage endurance at rated load ≥100000 switching cycles
 Switching frequency at rated load ≤ 1200/h
 Protection class IP40
 Weight 95 g

Standard types

VAC 50 Hz/60 Hz: 24, 48, 115 (120), 230 (240)

C5-R20/AC ... V

VDC : 12, 24, 48, 110,

C5-R20/DC ... V

"..." Enter the voltage for full type designation

Accessories

Socket: **S5-S, S5-L, S5-P, S5-P0, S5-M**
 Optional accessories (blanking plug): **SO-NP, SO-OP**



Connection diagram

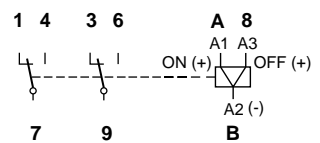


Fig. 1 AC voltage endurance

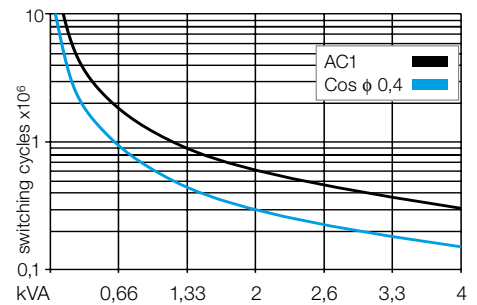
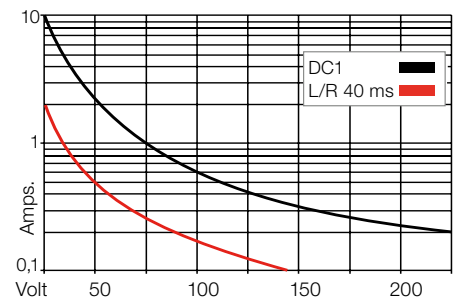
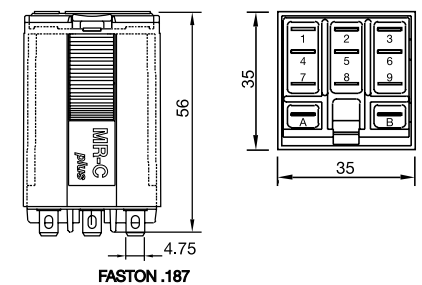


Fig. 2 DC load limit curves



Dimensions [mm]



Technical approvals, conformities



IEC 61810, EN 60947

1.1.2 Miniature Industrial Relays

QRC Series



Application	Types	Pins	Contacts	AC ratings	DC ratings	Socket
C7 Series						
Miniature power relay	C7-A1x			16 A / 250 V	0.5 A / 110 V	S7
General purpose	C7-A2x			10 A / 250 V	0.5 A / 110 V	S7
Low switching load	C7-T2x			6 A / 250 V	6 A / 30 V	S7
DC load switching	C7-G2x			10 A / 250 V	0.8 A / 110 V	S7
DC load switching double make	C7-X1x			10 A / 250 V	6 A / 110 V	S7
1 power and 1 signal contact	C7-H23			10 A / 250 V	6 A / 30 V	S7
Power relay for high inrush current	C7-W1x			10 A / 250 V 500 A / 2.5 ms inrush		S7
Railway application	R7-A2x			10 A / 250 V	10 A / 30 V	S7
Railway application	R7-T2x			6 A / 250 V	6 A / 30 V	S7
C9 Series						
Miniature relay	C9-A4x			5 A / 250 V	5 A / 30 V	S9
Sensitive Coil 500mW ... 800mW	C9-E2x			5 A / 250 V	5 mA / 30 V	S9
Latching relay	C9-R2x			5 A / 120 V	5 A / 30 V	S9

Type	C7-A1x/ ... V Standard relay 1 change-over contact
-------------	---

Maximum contact load	16 A/250 V AC1	0,5 A/110 V DC1
	16 A/30 V DC1	0,2 A/220 V DC1

Contacts			
Material	Standard	Code 0	AgNi
Rated current			16 A
Switch-on current max. (20 ms)			40 A
Switching voltage max.			250 V
AC load (Fig 1)			4 kVA
DC load			see Fig. 2
Relay compatible with socket S7-16			

Coil	
Coil resistance	see table; tolerance $\pm 10\%$
Pick-up voltage	$\leq 0,8 \times U_N$
Release voltage	$\geq 0,1 \times U_N$
Nominal power	1,2 VA (AC)/1,3 W (DC)

Coil table	VAC	Ω	mA	VDC	Ω	mA
	24	174	50	12	111	108
	48	686	25	24	432	55
	115	4K3	10,4	48	1K7	28
	230	18K6	5,2	110	9K2	12

Insulation	
Contact open	Volt rms, 1 min 1000 V
Contact/coil	2,5 kV
Insulation resistance at 500 V	$\geq 1 \text{ G}\Omega$
Insulation, IEC 61810-1	2,5 kV/3

Specifications	
Ambient temperature operation/storage	-40 (no ice)...60 °C / -40 ... 80 °C
Pick-up time/bounce time	16 ms/ ≤ 3 ms
Release time/bounce time	8 ms/ ≤ 1 ms
Mechanical life ops	AC: 10 Mill./DC: 20 Mill.
DC voltage endurance at rated load	≥ 100000 switching cycles
Switching frequency at rated load	$\leq 1200/\text{h}$
Protection class	IP40
Weight	43 g

Standard types	C7-A10/AC ... V C7-A10X/AC ... V
VAC 50 Hz/60 Hz: 24, 48, 115 (120), 230 (240) LED	
VDC 12, 24, 48, 110 LED	C7-A10/DC ... V C7-A10X/DC ... V
Free wheeling diode	C7-A10DX/DC ... V C7-A10FX/DC ... V
Polarity and free wheeling diode	
AC/DC bridge rectifier 24 V, 48 V, 60 V	C7-A10BX/UC ... V

"..." Enter the voltage for full type designation

Accessories	
Socket:	S7-16



Connection diagram

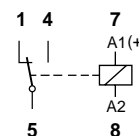


Fig. 1 AC voltage endurance

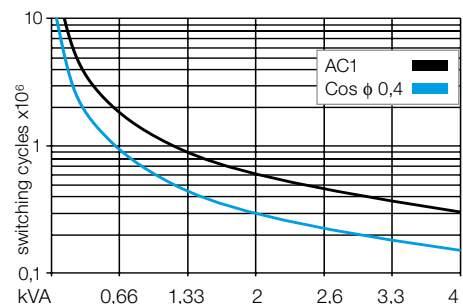
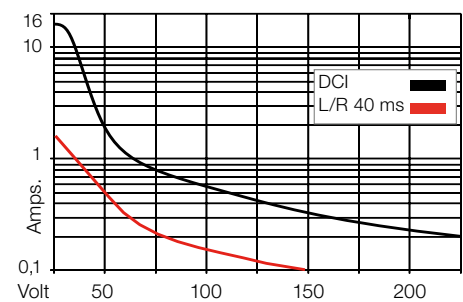
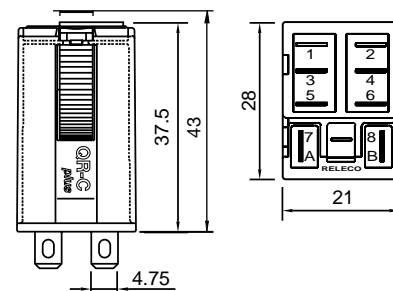


Fig. 2 DC load limit curve



Dimensions [mm]



Technical approvals, conformities



IEC 61810; EN 60947

Type	C7-A2x/ ... V Standard relay 2 change-over contact		
Maximum contact load	10 A/250 V AC1	0,5 A/110 V DC1	
	10 A/30 V DC1	0,2 A/220 V DC1	
Recommended minimum contact load	10 mA/10 V Code 0, 9		
	5 mA/5 V Code 8		

Contacts			
Material	Standard	Code 0	AgNi
	Optional	Code 8	AgNi + 10 μ Au
	Optional	Code 9	AgNi + 0,2 μ Au
Rated current	10 A		
Switch-on current max. (20 ms)	30 A		
Switching voltage max.	250 V		
AC load (Fig 1)	2,5 kVA		
DC load	see Fig. 2		

Coil			
Coil resistance	see table; tolerance ± 10 %		
Pick-up voltage	≤ 0,8 × U _N		
Release voltage	≥ 0,1 × U _N		
Nominal power	1,2 VA (AC)/1 W (DC)		

Coil table					
VAC	Ω	mA	VDC	Ω	mA
24	174	50	12	148	85
48	686	25	24	594	43
115	4K3	10,4	48	2K3	21
230	18K6	5,2	110	11K4	10

Insulation	Volt rms, 1 min
Contact open	1000 V
Contact/contact	2,5 kV
Contact/coil	2,5 kV
Insulation resistance at 500 V	≥ 1 G.Ω
Insulation, IEC 61810-1	2,5 kV/3

Specifications	
Ambient temperature operation/storage	-40 (no ice)...60 °C /-40 ... 80 °C
Pick-up time/bounce time	16 ms/≤ 3 ms
Release time/bounce time	8 ms/≤ 1 ms
Mechanical life ops	AC: 10 Mill./DC: 20 Mill.
DC voltage endurance at rated load	≥ 100000 switching cycles
Switching frequency at rated load	≤ 1200/h
Protection class	IP40
Weight	43 g

Standard types			
VAC 50 Hz/60 Hz: 24, 48, 115 (120), 230 (240)	C7-A20/AC ... V	C7-A28/AC ... V	C7-A29/AC ... V
LED	C7-A20X/AC ... V	C7-A28X/AC ... V	C7-A29X/AC ... V
VDC 12, 24, 48, 110	C7-A20/DC ... V	C7-A28/DC ... V	C7-A29/DC ... V
LED	C7-A20X/DC ... V	C7-A28X/DC ... V	C7-A29X/DC ... V
Free wheeling diode	C7-A20DX/DC ... V	C7-A28DX/DC ... V	C7-A29DX/DC ... V
Polarity and free wheeling diode	C7-A20FX/DC ... V	C7-A28FX/DC ... V	C7-A29FX/DC ... V
AC/DC bridge rectifier 24 V, 48 V, 60 V	C7-A20BX/UC ... V	C7-A28BX/UC ... V	C7-A29BX/UC ... V

"..." Enter the voltage for full type designation

Accessories	
Socket:	S7-M, S7-I/O, S7-L, S7-P, S7-P0



Connection diagram

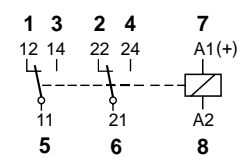


Fig. 1 AC voltage endurance

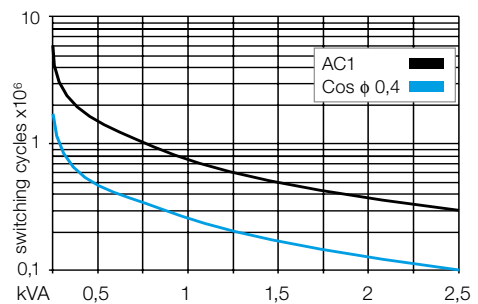
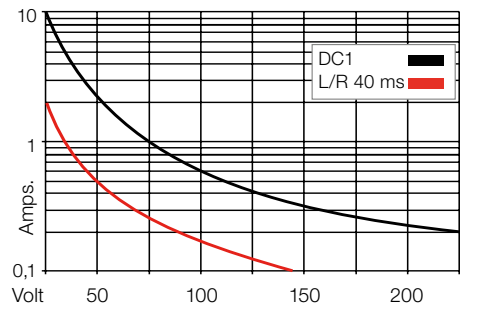
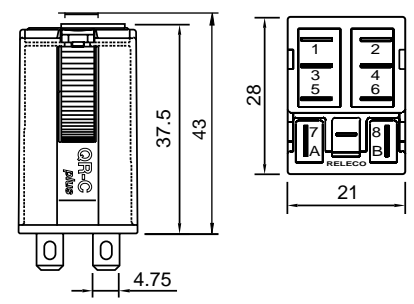


Fig. 2 DC load limit curve



Dimensions [mm]



Technical approvals, conformities



Type	C7-T2x/ ... V Standard relays for low level 2 change-over bifurcated contacts			
Maximum contact load	6 A/250 V	AC1	6 A/30 V	DC1
Recommended minimum contact load	5 mA/5 V	Code 1		
	1 mA/5 V	Code 2		

Contacts			
Material	Standard	Code 1	AgNi + 0,2 μ Au
	Optional	Code 2	AgNi + 10 μ Au
Rated current	6 A		
Switch-on current max. (20 ms)	15 A		
Switching voltage max.	250 V		
AC load (Fig 1)	1,2 kVA		
DC load	see fig. 2		

Coil			
Coil resistance	see table; tolerance ± 10 %		
Pick-up voltage	≤ 0,8 × U _N		
Release voltage	≥ 0,1 × U _N		
Nominal power	1,2 VA (AC)/1 W (DC)		

Coil table						
	VAC	Ω	mA	VDC	Ω	mA
	24	174	50	12	148	85
	48	686	25	24	594	43
	115	4K3	10,4	48	2K3	21
	230	18K6	5,2	110	11K4	10

Insulation	Volt rms, 1 min
Contact open	1000 V
Contact/contact	2,5 kV
Contact/coil	2,5 kV
Insulation resistance at 500 V	≥ 1 GΩ
Insulation, IEC 61810-1	2,5 kV/3

Specifications	
Ambient temperature operation/storage	-40 (no ice)...60 °C /-40 ... 80 °C
Pick-up time/bounce time	16 ms/≤ 3 ms
Release time/bounce time	8 ms/≤ 1 ms
Mechanical life ops	AC: 10 Mill./DC: 20 Mill.
DC voltage endurance at rated load	≥ 100000 switching cycles
Switching frequency at rated load	≤ 1200/h
Protection class	IP40
Weight	43 g

Standard types		
VAC 50 Hz/60 Hz: 24, 48, 115 (120), 230 (240) LED	C7-T21/AC ... V C7-T21X/AC ... V	C7-T22/AC ... V C7-T22X/AC ... V
VDC 12, 24, 48, 110 LED	C7-T21/DC ... V C7-T21X/DC ... V	C7-T22/DC ... V C7-T22X/DC ... V
Free wheeling diode	C7-T21DX/DC ... V	C7-T22DX/DC ... V
Polarity and free wheeling diode	C7-T21FX/DC ... V	C7-T22FX/DC ... V
AC/DC bridge rectifier 24 V, 48 V, 60 V	C7-T21BX/UC ... V	C7-T22BX/UC ... V

"..." Enter the voltage for full type designation

Accessories	
Socket:	S7-M, S7-I/O, S7-L, S7-P, S7-P0



Connection diagram

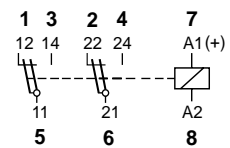


Fig. 1 AC voltage endurance

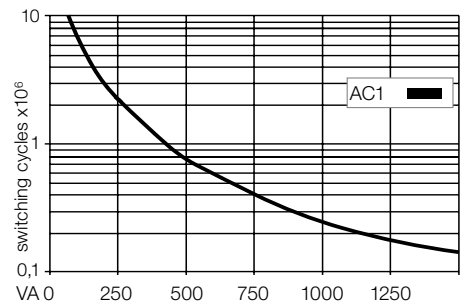
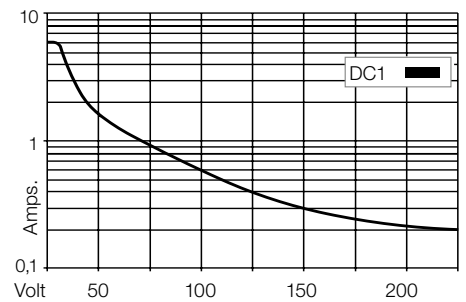
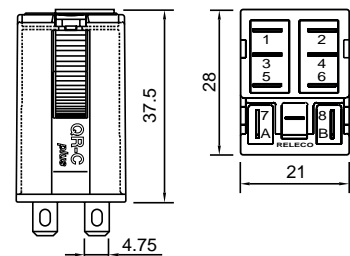


Fig. 2 DC load limit curve



Dimensions [mm]



Technical approvals, conformities



IEC 61810; EN 60947



Type	C7-G2x/ ... V Power relay, DC application 2 open contacts, gap 1,5mm		
-------------	---	--	--

Maximum contact load	10 A/250 V AC1	0,8 A/110 V DC1
	10 A/30 V DC1	0,4 A/220 V DC1

Contacts			
Material	Standard	Code 0	AgNi
Rated current			10 A
Switch-on current max. (20 ms)			30 A
Switching voltage max			250 V
AC load (Fig 1)			2,5 kVA
DC load			see fig. 2

Coil	
Coil resistance	see table; tolerance $\pm 10\%$
Pick-up voltage	$\leq 0,8 \times U_N$
Release voltage	$\geq 0,1 \times U_N$
Nominal power	1,5 VA (AC)/1,5 W (DC)

Coil table					
VAC	Ω	mA	VDC	Ω	mA
24	153	62	12	99	121
48	611	31	24	388	61
115	3K6	13	48	1K5	32
230	14K6	6,5	110	8K	14

Insulation	
	Volt rms, 1 min
Contact open	2000 V
Contact/contact	2,5 kV
Contact/coil	2,5 kV
Insulation resistance at 500 V	$\geq 1 \text{ G}\Omega$
Insulation, IEC 61810-1	2,5 kV/3

Specifications	
Ambient temperature operation/storage	-40 (no ice)...60 °C / -40 ... 80 °C
Pick-up time/bounce time	20 ms/ ≤ 3 ms
Release time/bounce time	10 ms/ ≤ 1 ms
Mechanical life ops	AC: 10 Mill./DC: 20 Mill.
DC voltage endurance at rated load	≥ 100000 switching cycles
Switching frequency at rated load	≤ 1200 /h
Protection class	IP40
Weight	43 g

Standard types	
VAC 50 Hz/60 Hz: 24, 48, 115 (120), 230 (240) LED	C7-G20/AC ... V C7-G20X/AC ... V
VDC 12, 24, 48, 110 LED	C7-G20/DC ... V C7-G20X/DC ... V
Free wheeling diode	C7-G20DX/DC ... V C7-G20FX/DC ... V
Polarity and free wheeling diode	
AC/DC bridge rectifier 24 V, 48 V, 60 V	C7-G20BX/UC ... V

"..." Enter the voltage for full type designation

Accessories	
Socket:	S7-M, S7-I/O, S7-L, S7-P, S7-P0

Connection diagram

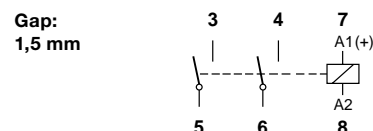


Fig. 1 AC voltage endurance

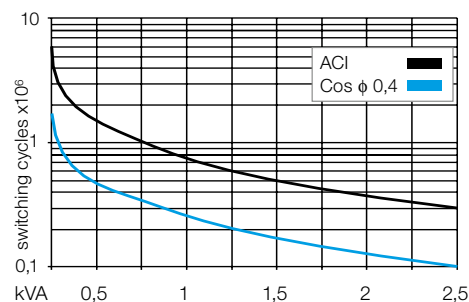
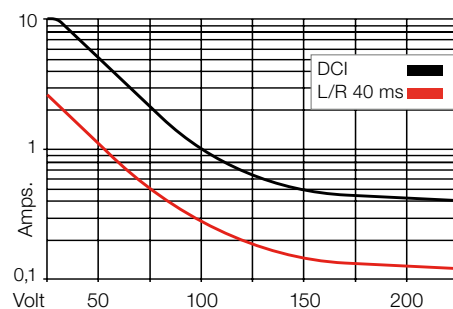
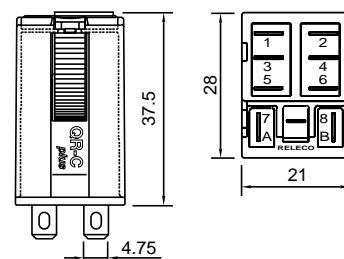


Fig. 2 DC load limit curve



Dimensions [mm]



Technical approvals, conformities



IEC 61810; EN 60947

Type **C7-X1x/ ... V**
 Power relay, DC application
 1 pole, NO, double make

Maximum contact load	10 A/250 V AC1	6 A/110 V DC1
	10 A/30 V DC1	1 A/220 V DC1

Contacts

Material	Standard	Code 0	AgNi
Rated current			10 A
Switch-on current max. (20 ms)			30 A
Switching voltage max.			250 V
AC load			2,5 kVA
DC load			see Fig. 2

Coil

Coil resistance	see table; tolerance ± 10 %
Pick-up voltage	≤ 0,8 × U _N
Release voltage	≥ 0,1 × U _N
Nominal power	1,5 VA (AC)/1,3 W (DC)

Coil table

VAC	Ω	mA	VDC	Ω	mA
24	153	62	12	111	108
48	611	31	24	432	55
115	3K6	13	48	1K7	27
230	14K6	6,5	110	9K2	12

Insulation Volt rms, 1 min

Contact open	2,5 kV
Contact/coil	2,5 kV
Insulation resistance at 500 V	≥ 1 GΩ
Insulation, IEC 61810-1	2,5 kV/3

Specifications

Ambient temperature operation/storage	-40 (no ice)...60 °C / -40 ... 80 °C
Pick-up time/bounce time	20 ms/≤ 3 ms
Release time/bounce time	10 ms/≤ 1 ms
Mechanical life ops	AC: 10 Mill./DC: 20 Mill.
DC voltage endurance at rated load	≥ 100000 switching cycles
Switching frequency at rated load	≤ 1200/h
Protection class	IP40
Weight	43 g

Standard types
VAC 50 Hz/60 Hz: 24, 48, 115 (120), 230 (240)
LED

VDC 12, 24, 48, 110
LED
Free wheeling diode
Polarity and free wheeling diode

AC/DC bridge rectifier 24 V, 48 V, 60 V

- C7-X10/AC ... V
- C7-X10X/AC ... V
- C7-X10/DC ... V
- C7-X10X/DC ... V
- C7-X10DX/DC ... V
- C7-X10FX/DC ... V
- C7-X10BX/UC ... V

"..." Enter the voltage for full type designation

Accessories
 Socket: **S7-M, S7-I/O, S7-L, S7-P, S7-P0**



Connection diagram

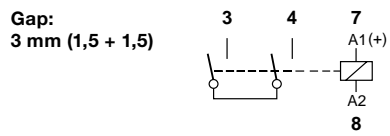


Fig. 1 AC voltage endurance

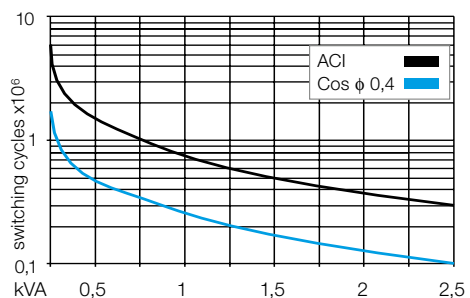
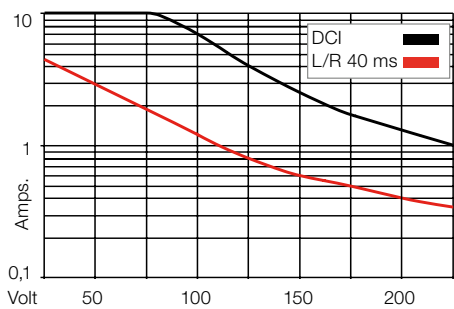
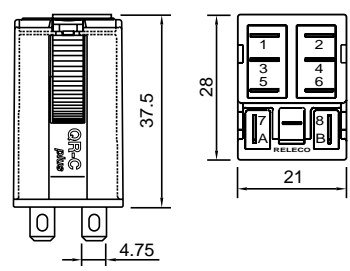


Fig. 2 DC load limit curve



Dimensions [mm]



Technical approvals, conformities



IEC 61810; EN 60947

Type	C7-H23/ ... V Special relays 1 x CO power contact 1 x CO twin contact
Maximum contact load	10 A 250 V AC1 6 A 250 V AC1 10 A 30 V DC1 6 A 30 V DC1
Recommended minimum contact load	10 mA/10 V (Power contacts) 5 mA/5V (twin contacts)

Contacts	
Power contact	
Standard material	AgNi
Rated current	10 A
Switch-on current max. (20 ms)	30 A
Switching voltage max.	2,5 kV
AC load (Fig 1)	2,5 kVA
DC load	see fig. 2

Twin contact	
Standard material	AgNi + 0,2 μ Au
Rated current	6 A
Switch-on current max. (20 ms)	15 A
Switching voltage max.	250 V

Coil	
Coil resistance	see table; tolerance ± 10 %
Pick-up voltage	≤ 0,8 x U _N
Release voltage	≥ 0,1 x U _N
Nominal power	1,2 VA (AC) / 1 W (DC)

Coil table	VAC Ω ± 10% mA	VDC Ω ± 10% mA
	24 174 50	12 148 81
	48 686 25	24 594 40
	115 4K3 10.4	48 2K3 21
	230 18K6 5.2	110 11K4 10

Insulation	Volt rms, 1 min
Contact open	1000 V
Contact/contact	2,5 kV
Contact/coil	2,5 kV
Insulation, IEC 61810-1:	2,5 kV/3

Specifications	
Ambient temperature operation/storage	40 (no ice)...60 °C / -40 ... 80 °C
Mechanical life ops	AC: 10 Mill./DC: 20 Mill.
Protection class	IP40
Weight	43 g

Standard types	C7-H23/AC ... V C7-H23X/AC ... V
VAC 50 Hz/60 Hz: 24, 48, 115 (120), 230 (240) LED	C7-H23/DC ... V C7-H23X/DC ... V C7-H23DX/DC ... V C7-H23FX/DC ... V
VDC 12,24, 48, 110 LED	C7-H23BX/UC ... V
Free wheeling diode	
Polarity and free wheeling diode	
UC 24 V, 48 V, 60 V	

"..." Enter the voltage for full type designation

Accessories	
Socket:	S7-M, S7-I/O, S7-L, S7-P, S7-P0



Connection diagram

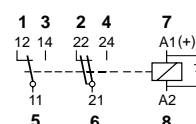


Fig. 1 AC voltage endurance

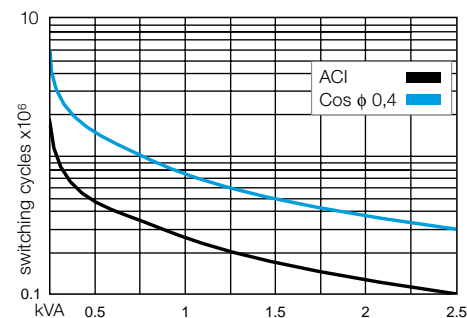
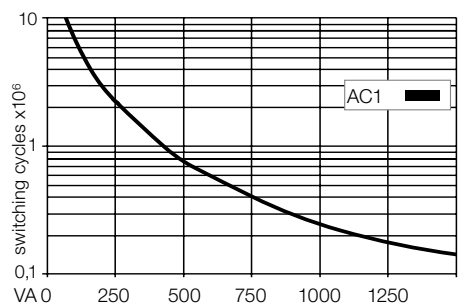
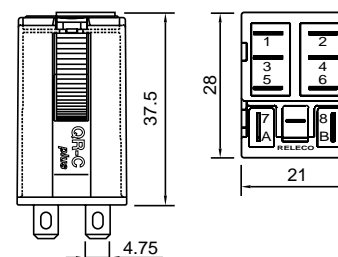


Fig. 2 AC voltage endurance



Dimensions [mm]



Technical approvals, conformities



IEC 61810; EN 60947

Type: **C7-W1x/ ... V**
 Power relay for high inrush current
 1 pole normally open

Maximum contact load: **10 A/250 V AC** **6 A/250 V AC5a/b**
Recommended minimum contact load: **10 mA/10 V**

Contacts

Material	Standard	Code 0	AgNi/W
Rated current			10 A
Switch-on current max. (2,5 ms)			500 A
Switching voltage max.			250 V
AC load (Fig 1)			2,5 kVA
DC load			see fig. 2

Coil

Coil resistance	see table; tolerance ± 10 %
Pick-up voltage	≤ 0,8 × U _N
Release voltage	≥ 0,1 × U _N
Nominal power	1,5 VA (AC)/1,5 W (DC)

Coil table

VAC	Ω	mA	VDC	Ω	mA
24	153	62	12	99	121
48	611	31	24	388	61
115	3K6	13	48	1K5	32
230	14K5	6,5	110	8K	14

Insulation

	Volt rms, 1 min
Contact open	1000 V
Contact/coil	2,5 kV
Insulation resistance at 500 V	≥ 1 GΩ
Insulation, IEC 61810-1	2,5 kV

Specifications

Ambient temperature operation/storage	-40 (no ice)...60 °C / -40 ... 80 °C
Pick-up time/bounce time	20 ms/≤ 3 ms
Release time/bounce time	10 ms/≤ 1 ms
Mechanical life ops	AC: 10 Mill./DC: 20 Mill.
DC voltage endurance at rated load	≥ 100000 switching cycles
Switching frequency at rated load	≤ 1200/h
Protection class	IP40
Weight	43 g

Standard types

VAC 50 Hz/60 Hz: **24, 48, 115 (120), 230 (240) LED**

VDC **12, 24, 48, 110 LED**

Free wheeling diode

Polarity and free wheeling diode

AC/DC bridge rectifier 24 V, 48 V, 60 V

C7-W10/AC ... V
C7-W10X/AC ... V

C7-W10/DC ... V
C7-W10X/DC ... V
C7-W10DX/DC ... V
C7-W10FX/DC ... V

C7-W10BX/UC ... V

"..." Enter the voltage for full type designation

Accessories

Socket: **S7-M, S7-I/O, S7-L, S7-P, S7-P0**
 Optional accessories (blanking plug): **S9-NP, S9-OP**



Connection diagram

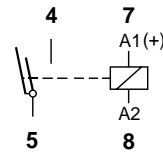


Fig. 1 AC voltage endurance

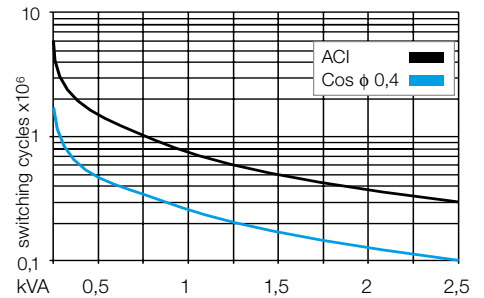
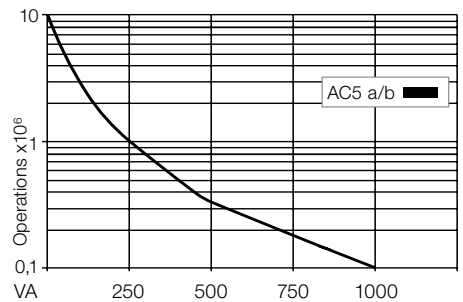
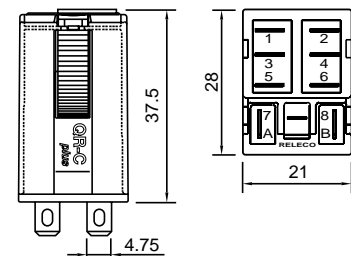


Fig. 2 AC voltage endurance



Dimensions [mm]



Technical approvals, conformities



IEC 61810; EN 60947

R7-A2x

8-pin, miniature standard relay, 2-pole, plug-in

Relay approval: EN 60077-1-2/99 - EN 61373/99 for Railway application

Type	R7-A2x/DC ... V Railway application Sensitive, 2 change-over contacts
-------------	--

Maximum contact load:	10 A/250 V AC1 10A/30V DC1
Recommended minimum contact load	10 mA/10 V Code 0, 4 5 mA/5 V Code 8

Contacts

Material	Standard	Code 0	AgNi
	Optional	Code 4	AgNi + 0,2µ Au
	Optional	Code 8	AgNi + 10µ Au
Rated current	10 A		
Switch-on current max. (20 ms)	30 A		
Switching voltage max.	250 V		
AC load	see fig. 1		
DC load	see fig. 2		

Coil

Coil resistance	see table; tolerance ± 10 %
Pick-up voltage	0,7 U _N ... 1,25 U _N
Release voltage	≥ 0,1 x U _N
Nominal power	1,07 W

Coil table

Voltage	Ω ± 10%	mA
24	535	45
48	2004	24
72	4750	15
110	11337	10

Insulation	Volt rms, 1 min
Pollution grade	PD3
Pulse (1,2 /50µs) Dielectric strenght (1Minute/V rms)	
Contact/coil	4KV / 2200V
Between different poles	4KV / 2200V
Between contact and the same pole	1550 / 850V

Specifications

Ambient temperature operation/storage	-25 (no ice)...70 °C / -40 ... 80 °C
Number of mechanical operations	>20millions
Thermic class	B (130° C)
Vibration : category / class	1 / B Body mounted
Vibration	5-150Hz (3 axes)
Shock	5g (3 axes)
Operation (UN) / release time	10 ms/ 15 ms
Weight	35 g
Weight avg. Relay + Socket (S7-M)	75g
Protection class	IP40

Standard types

VDC 24, 48, 72, 110	R7-A20/DC ... V	R7-A24/DC ... V	R7-A28/DC ... V
LED	R7-A20X/DC ... V	R7-A24X/DC ... V	R7-A28X/DC ... V
Free wheeling diode	R7-A20D/DC ... V	R7-A24D/DC ... V	R7-A28D/DC ... V
LED + free wheeling diode	R7-A20DX/DC ... V	R7-A24DX/DC ... V	R7-A28DX/DC ... V

"..." Enter the voltage for full type designation

Accessories

Socket:	S7-M, S7-I/O, S7-L, S7-P, S7-P0
---------	--



Connection diagram

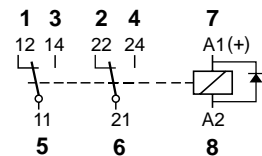


Fig. 1 AC voltage endurance

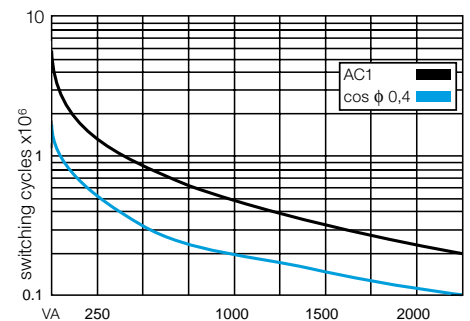
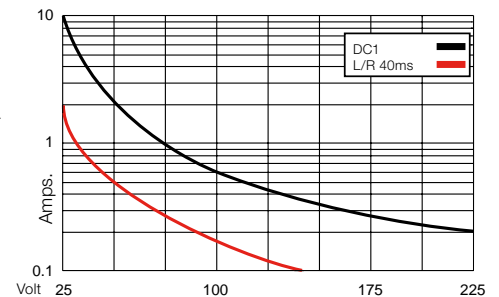
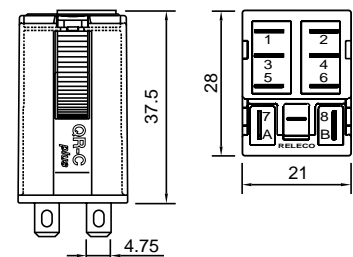


Fig. 2 DC load limit curve



Dimensions [mm]



Technical approvals, conformities



EN 60077-1-2/99; EN 61373/99

R7-T2x

8-pin, miniature industrial relay, 2-pole, change-over contact, faston
Relay approval: EN 60077-1-2/99 - EN 61373/99 for Railway application



Type	R7-T2x/DC ... V Railway application Sensitive, 2 change-over contact		
Maximum contact load	6 A 250 V AC1		6 A 30 V DC1
Recommended minimum contact load	5 mA/5 V Code 1		1 mA/5 V Code 2

Contacts			
Material	Standard	Code 1	AgNi + 0,2μ Au
	Optional	Code 2	AgNi + 10μ Au
Rated current	6 A		
Switch-on current max. (20 ms)	15 A		
Switching voltage max.	250 V		
AC load	see fig. 1		
DC load	see fig. 2		

Coil	
Coil resistance	see table; tolerance ± 10 %
Contact open	0,7 U _N ... 1,25 U _N
Operation range	≥ 0,1 x U _N
Nominal power	1,07 W

Coil table			
	Voltage	Ω ± 10%	mA
	24	535	45
	48	2004	24
	72	4750	15
	110	11337	10

Insulation	Volt rms, 1 min
Pollution grade	PD3
Pulse (1,2 /50hs) Dielectric strenght (1Minute/V rms)	
Contact/coil	4KV / 2200V
Between different poles	4KV / 2200V
Between contact and the same pole	1550 / 850V

Specifications	
Ambient temperature operation/storage	-25 (no ice)...70 °C / -40 ... 80 °C
Number of mechanical operations	≥ 20 millions
Thermic class	B (130° C)
Vibration : category / class	1 / B Body mounted
Vibration	5-150Hz (3 axes)
Shock	5g (3 axes)
Operation (UN) / release time	10 ms/ 15 ms
Weight	35 g
Weight avg. Relay + Socket (S7-M)	75g
Protection class	IP40

Standard types		
VDC 24, 48, 72, 110	R7-T21/DC ... V	R7-T22/DC ... V
LED	R7-T21X/DC ... V	R7-T22X/DC ... V
Free wheeling diode	R7-T21D/DC ... V	R7-T22D/DC ... V
LED + free wheeling diode	R7-T21DX/DC ... V	R7-T22DX/DC ... V

"..." Enter the voltage for full type designation

Accessories	
Socket:	S7-M, S7-I/O, S7-L, S7-P, S7-P0



Connection diagram

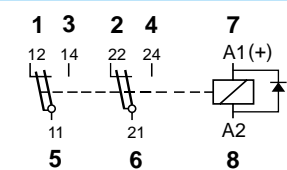


Fig. 1 AC voltage endurance

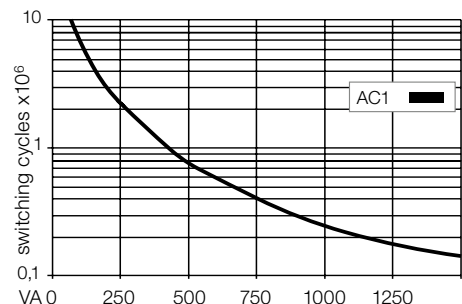
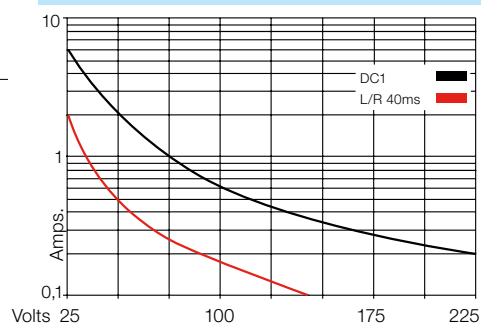
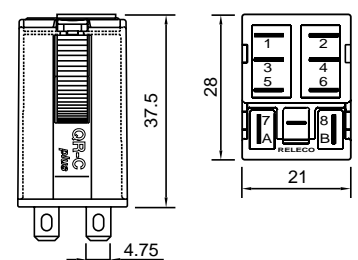


Fig. 2 DC load limit curve



Dimensions [mm]



Technical approvals, conformities



IEC 60077; EN 60077-1-2/99; EN 61373/99

Type	C9-A4x/ ... V Standard relays 4 change-over contacts			
Maximum contact load	5 A/250 V AC 1	5 A/30 V DC1		
Recommended minimum contact load	10 mA/10 V Code 1	5 mA/5 V Code 2		

Contacts				
Material	Standard	Code 1	AgNi + 0,2 μ Au	
	Optional	Code 2	AgNi + 10 μ Au	
Rated current	5 A			
Switch-on current max. (20 ms)	15 A			
Switching voltage max (same polarity)	250 V			
AC load (Fig 1)	1,250 kVA			
DC load	see Fig. 2			

Coil				
Coil resistance	see table; tolerance ± 10 %			
Pick-up voltage	≤ 0,8 × U _N			
Release voltage	≥ 0,1 × U _N			
Nominal power	1,2 VA (AC)/1 W (DC)			

Coil table					
VAC	Ω	mA	VDC	Ω	mA
24	174	50	12	148	81
48	686	25	24	594	40
115	4K3	10,4	48	2K3	21
230	18K6	5,2	110	11K4	11

Insulation		Volt rms, 1 min
Contact open		1000 V
Contact/contact		2 kV
Contact/coil		2,5 kV
Insulation resistance at 500 V		≥ 1 GΩ
Insulation, IEC 61810-1		2,5 kV/3

Specifications	
Ambient temperature operation/storage	-40 (no ice)...60 °C / -40 ... 80 °C
Pick-up time/bounce time	10 ms/≤ 3 ms
Release time/bounce time	6 ms/≤ 1 ms
Mechanical life ops	AC: 10 Mill./DC: 20 Mill.
DC voltage endurance at rated load	≥ 100000 switching cycles
Switching frequency at rated load	≤ 1200/h
Protection class	IP40
Weight	43 g

Standard types		
VAC 50 Hz/60 Hz: 24, 48, 115, 230 (240) LED	C9-A41/AC ... V C9-A41X/AC ... V	C9-A42/AC ... V C9-A42X/AC ... V
VDC 12, 24, 48, 110 LED	C9-A41/DC ... V C9-A41X/DC ... V	C9-A42/DC ... V C9-A42X/DC ... V
Free wheeling diode	C9-A41DX/DC ... V	C9-A42DX/DC ... V
Polarity and free wheeling diode	C9-A41FX/DC ... V	C9-A42FX/DC ... V
AC/DC bridge rectifier 24 V, 48 V, 60 V	C9-A41BX/UC ... V	C9-A42BX/UC ... V

"..." Enter the voltage for full type designation

Accessories	
Socket:	S9-M, S9-L, S9-P, S9-P0
Optional accessories (blanking plug):	S9-NP, S9-OP



Connection diagram

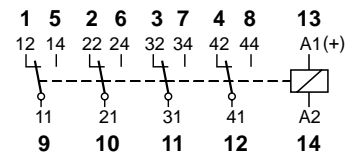


Fig. 1 AC voltage endurance

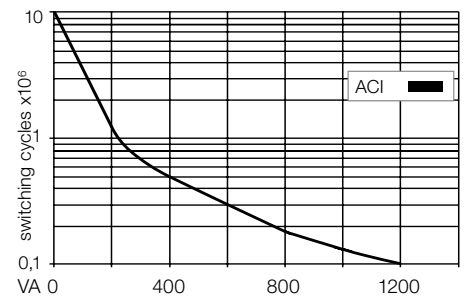
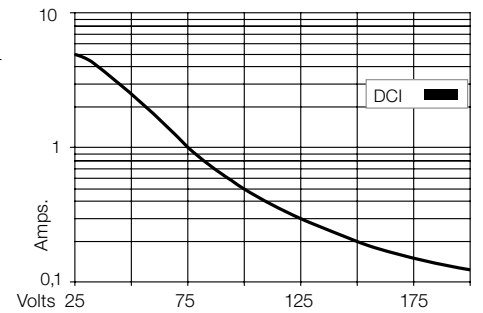
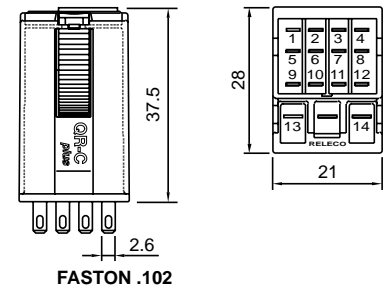


Fig. 2 DC load limit curve



Dimensions [mm]



Technical approvals, conformities



Type	C9-E2x/ ... V Sensitive relay, 500 mW 2 change-over contacts			
DC operating range	0,8 ... 1,7 x U_N			
Maximum contact load	5 A/250 V AC1	5 A/30 V	DC1	
Recommended minimum contact load	10 mA/10 V Code 1	5 mA/5 V Code 2		

Contacts			
Material	Standard	Code 1	AgNi + 0,2 μ Au
	Optional,	Code 2	AgNi + 10 μ Au
Rated current	5 A		
Switch-on current max. (20 ms)	15 A		
Switching voltage max.	250 V		
AC load (Fig 1)	1200 VA		
DC load	see fig. 2		

Coil			
Coil resistance	see table; tolerance ± 10 %		
Pick-up voltage	≤ 0,8 x U _N		
Release voltage	≥ 0,1 x U _N		
Nominal power	0,8 VA (AC)/0,5 W (DC)		

Coil table					
VAC	Ω	mA	VDC	Ω	mA
24	238	33	12	288	42
48	1K	17	24	1K1	21
115	5K9	7	48	4K6	10
230	23K9	3,5	110	24K2	4,5

Insulation	Volt rms, 1 min
Contact open	1000 V
Contact/contact	2,5 kV
Contact/coil	2,5 kV
Insulation resistance at 500 V	≥ 1 GΩ
Insulation, IEC 61810-1	2,5 kV/3

Specifications	
Ambient temperature operation/storage	-40 (no ice)...60 °C / -40 ... 80 °C
Pick-up time/bounce time	10 ms/≤ 3 ms
Release time/bounce time	6 ms/≤ 1 ms
Mechanical life	AC: 10 Mill./DC: 20 Mill.
DC voltage endurance at rated load	≥ 100000 switching cycles
Switching frequency at rated load	≤ 1200/h
Protection class	IP40
Weight	40 g

Standard types		
VAC 50 Hz/60 Hz: 24, 48, 115, 230 (240) LED	C9-E21/AC ... V C9-E21X/AC ... V	C9-E22/AC ... V C9-E22X/AC ... V
VDC 12, 24, 48, 110, 220 LED	C9-E21/DC ... V C9-E21X/DC ... V	C9-E22/DC ... V C9-E22X/DC ... V
Free wheeling diode	C9-E21DX/DC ... V	C9-E22DX/DC ... V
Polarity and free wheeling diode	C9-E21FX/DC ... V	C9-E22FX/DC ... V
AC/DC bridge rectifier 24 V, 48 V, 60 V	C9-E21BX/UC ... V	C9-E22BX/UC ... V

"..." Enter the voltage for full type designation

Accessories	
Socket:	S9-M, S9-L, S9-P, S9-P0
Optional accessories (blanking plug):	S9-NP, S9-OP



Connection diagram

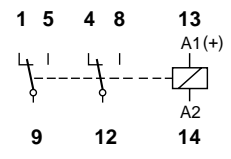


Fig. 1 AC voltage endurance

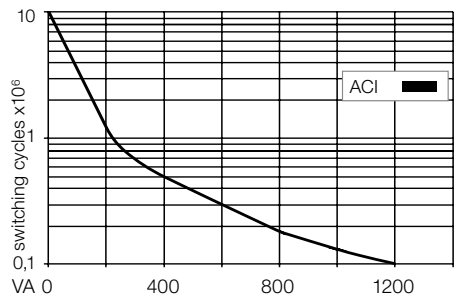
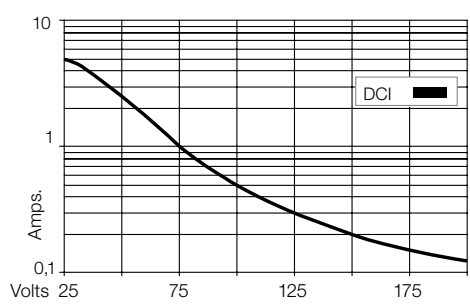
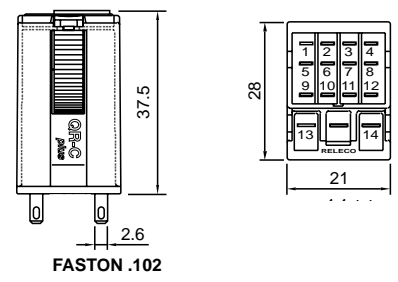


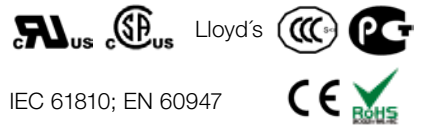
Fig. 2 DC load limit curve



Dimensions [mm]



Technical approvals, conformities



Type	C9-R2x/ ... V Magnetic latching relay 2 change-over contacts
-------------	---

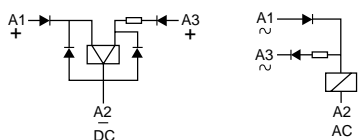
Maximum contact load	5 A/120V AC1 5 A/30 V DC1
-----------------------------	--

Recommended minimum contact load	10 mA/10 V
---	-------------------

Contacts			
Material	Standard	Code 1	AgNi + 0,2 μ Au
Rated current			5 A
Switch-on current max. (20 ms)			15 A
Switching voltage max.			120V
AC load			600 VA
DC load			see Fig. 2

Coil	
Coil resistance	see table; tolerance ± 10 %
ON pulse power	1,2 VA/W
OFF pulse power	0,3 VA/W
1 winding for AC, 2 winding for DC	

Internal Diagram:



Coil table

VAC	mA ON	mA OFF	VDC	mA ON	mA OFF
24	50	8	12	100	25
48	25	4	24	50	12
115	10	2	48	25	6
230	5	1	60	20	5

Insulation	Volt rms, 1 min
Contact open	1000 V
Contact/contact	2 kV
Contact/coil	2 kV
Insulation resistance at 500 V	≥1 GΩ
Insulation, IEC 61810-1	2,5 kV/2

Specifications	
Ambient temperature operation/storage	-40 (no ice)...60 °C / -40 ... 80 °C
Minimum pulse ON/OFF	50 ms
Mechanical life	AC: 10 Mill./DC: 20 Mill.
DC voltage endurance at rated load	≥100000 switching cycles
Switching frequency at rated load	≤ 1200/h
Protection class	IP40
Weight	43 g

Standard types	C9-R21/AC ... V
AC 50 Hz/60 Hz: 24, 48, 115, (120), 230	

DC 12, 24, 48, 60	C9-R21/DC ... V
--------------------------	------------------------

"..." Enter the voltage for full type designation

Accessories	
Socket:	S9-M, S9-L, S9-P, S9-P0
Optional accessories (blanking plug):	S9-NP, S9-OP



Connection diagram

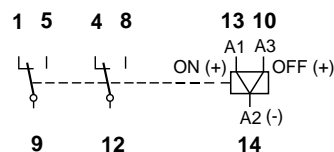


Fig. 1 AC voltage endurance

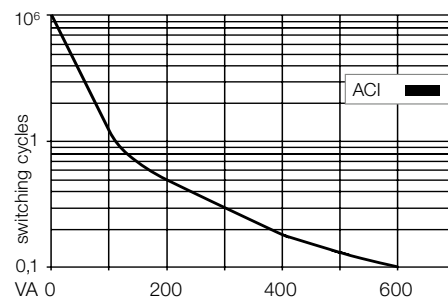
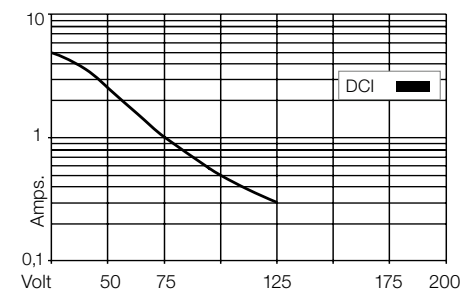
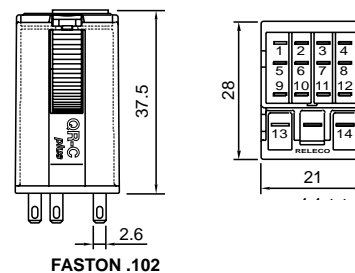


Fig. 2 DC load limit curve



Dimensions [mm]



Technical approvals, conformities



1.1.3 Interface Relays

IRC Series



Application	Types	Pins	Contacts	AC ratings	DC ratings	Socket
C10 Series						
Interface standard relay	C10-A1x			10 A / 250 V	10 A / 30 V	S10
DC load switching	C10-G1x			10 A / 250 V	10 A / 30 V	S10
Low switching load	C10-T1xx			6 A / 250 V	6 A / 30 V	S10
Low switching load	C10-GTxx			6 A / 250 V	6 A / 30 V	S10
C12 Series						
Interface relay	C12-A2x			5 A / 250 V	5 A / 30 V	S12
Interface DC relay	C12-G2x			5 A / 250 V	5 A / 30 V	S12

Type	C10-A1x/ ... V Standard relay, 1 change-over contact Contact Ag Sn O2 to high inrush		
Maximum contact load	10 A/250 V AC1	0,5 A/110 V DC1	
	10 A/30 V DC1	0,2 A/220 V DC1	
	13 A/250 V AC1	5A_{US}	
Recommended minimum contact load	10 mA/10 V Code 0,5		
	5 mA/5 V Code 8		

Contacts			
Material	Standard	Code 0	AgNi
	Optional	Code 8	AgNi+ 10 μ Au
	Optional	Code 5	Ag Sn O2
Rated current			10 A
Switch-on current max. (20 ms)			30 A (120 A for code 5)
Switching voltage max.			250 V
AC load (Fig 1)			2,5 kVA
DC load			see fig. 2

Coil			
Coil resistance			see table; tolerance ± 10 %
Pick-up voltage			≤ 0,8 × U _N
Release voltage			≥ 0,1 × U _N
Nominal power			1,1 VA (AC)/0,7 W (DC)

Coil table					
VAC	Ω	mA	VDC	Ω	mA
24	290	45	12	224	53
48	1200	23	24	742	32
115	7.300	9,5	48	3.500	13,7
230	28.800	4,7	110	19.900	5,5

Insulation		Volt rms, 1 min
Contact open		1000 V
Contact/coil		5 kV
Insulation resistance at 500 V		≥ 1 GΩ
Insulation, IEC 61810-1		4 kV/3

Specifications	
Ambient temperature operation/storage	-40 (no ice)...70 °C / -40 ... 80 °C
Pick-up time/bounce time	10 ms/ ≤ 1 ms
Release time/bounce time	5 ms/ ≤ 3 ms
Mechanical life ops	AC: 10 Mill./DC: 20 Mill.
DC voltage endurance at rated load	≥ 100000 switching cycles
Switching frequency at rated load	≤ 1200/h
Protection class	IP40
Weight	21 g

Standard types			
VAC 50 Hz/60 Hz: 24, 48, 115 (120), 230 (240)	C10-A10/AC...V	C10-A18/AC...V	C10-A15/AC...V
LED	C10-A10X/AC...V	C10-A18X/AC...V	C10-A15X/AC...V
RC suppressor	C10-A10R/AC...V	C10-A18R/AC...V	C10-A15R/AC...V
VDC 12, 24, 48, 110	C10-A10/DC...V	C10-A18/DC...V	C10-A15/DC...V
LED	C10-A10X/DC...V	C10-A18X/DC...V	C10-A15X/DC...V
Polarity and free wheeling diode	C10-A10FX/DC...V	C10-A18FX/DC...V	C10-A15FX/DC...V
VAC/DC bridge rectifier 24 V, 48 V	C10-A10BX/UC...V	C10-A18BX/UC...V	C10-A15BX/UC...V

"..." Enter the voltage for full type designation

Accessories	
Socket:	S10, S10-M, S10-P



Connection diagram

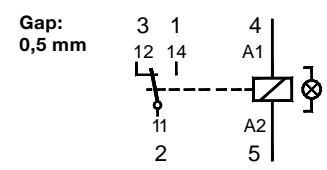


Fig. 1 AC voltage endurance

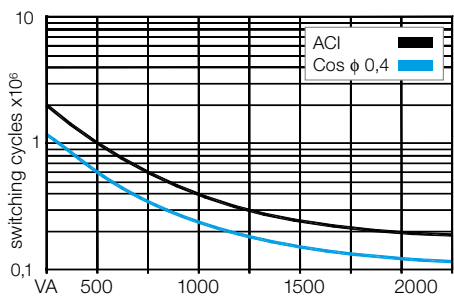
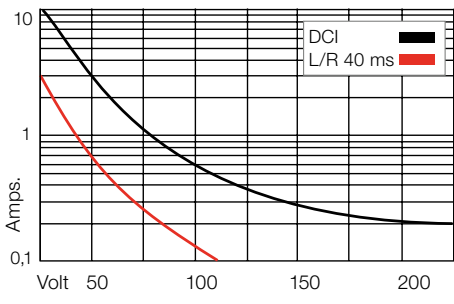
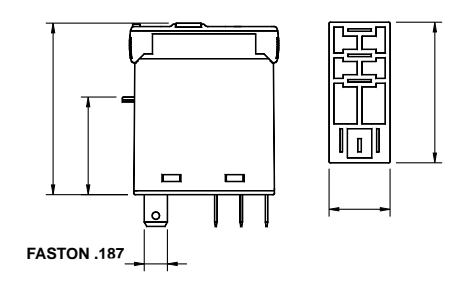


Fig. 2 DC load limit curve



Dimensions [mm]



Technical approvals, conformities



IEC 61810; EN 60947

Type	C10-G1X/ ... V Standard relay 1 open contact for high DC load Contact Ag Sn O2 to high inrush
-------------	---

Maximum contact load	10 A/250 V AC1 0,8 A/110 V DC1 10 A/30 V DC1 0,4 A/220 V DC1
Recommended minimum contact load	10 mA/10 V Code 0,5 5 mA/5 V Code 8

Contacts			
Material	Standard	Code 0	AgNi
	Optional	Code 8	AgNi +10 μ Au
	Optional	Code 5	Ag SnO2
Rated current	10 A		
Switch-on current max. (20 ms)	30 A (120 A for code 5)		
Switching voltage max.	250 V		
AC load (Fig 1)	2,5 kVA		
DC load	see Fig. 2		

Coil			
Coil resistance	see table; tolerance ± 10 %		
Pick-up voltage	≤ 0,8 x U _N		
Release voltage	≥ 0,1 x U _N		
Nominal power	1,1 VA (AC)/0,7 W (DC)		

Coil table					
VAC	Ω	mA	VDC	Ω	mA
24	290	45	12	224	53
48	1200	23	24	742	32
115	7.300	9,5	48	3.500	13,7
230	28.800	4,7	110	19.900	5,5

Insulation	Volt rms, 1 min
Contact open	2000 V
Contact/coil	5 kV
Insulation resistance at 500 V	≥ 1 GΩ
Insulation, IEC 61810-1	4 kV/3

Specifications	
Ambient temperature operation/storage	-40 (no ice)...70 °C /-40 ... 80 °C
Pick-up time/bounce time	10 ms/≤ 1 ms
Release time/bounce time	8 ms
Mechanical life ops	AC: 10 Mill./DC: 20 Mill.
DC voltage endurance at rated load	≥ 100000 switching cycles
Switching frequency at rated load	≤ 1200/h
Protection class	IP40
Weight	21 g

Standard types		
VAC 50 Hz/60 Hz: 24, 48, 115 (120), 230 (240)	C10-G10/AC ... V	C10-G15/AC ... V
LED	C10-G10X/AC ... V	C10-G15X/AC ... V
RC suppressor	C10-G10R/AC...V	C10-G15R/AC...V
VDC 12, 24, 48, 110	C10-G10/DC ... V	C10-G15/DC ... V
LED	C10-G10X/DC ... V	C10-G15X/DC ... V
Polarity and free wheeling diode	C10-G10FX/DC ... V	C10-G15FX/DC... V
AC/DC bridge rectifier 24 V, 48 V	C10-G10BX/DC ... V	C10-G15BX/UC... V

"..." Enter the voltage for full type designation

Accessories	
Socket:	S10, S10-M, S10-P



Connection diagram

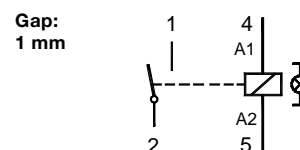


Fig. 1 AC voltage endurance

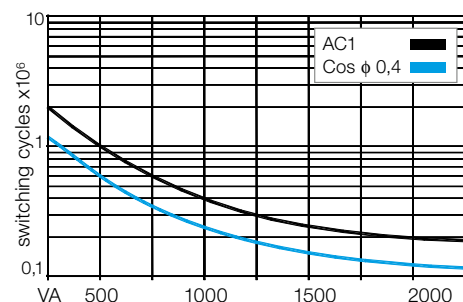
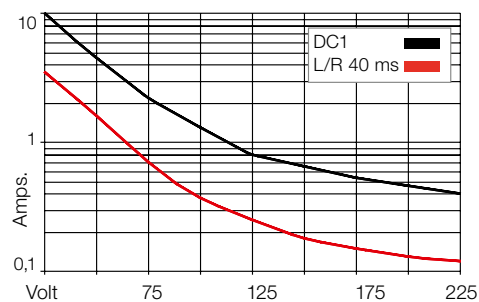
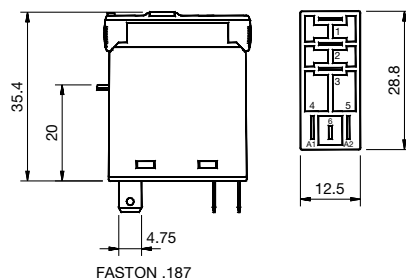


Fig. 2 DC load limit curve



Dimensions [mm]



Technical approvals, conformities



IEC 61810; EN 60947

Type	C10-T1x/ ... V Standard relay for low power application			
Maximum contact load	6 A/250 V	AC1	0,5 A/110 V	DC1
	6 A/30 V	DC1	0,2 A/220 V	DC1
Recommended minimum contact load	5 mA/5 V	Code 1		
	1 mA/5 V	Code 2		

Contacts			
Material	Standard	Code 1	AgNi + 0,2 μ Au
	Optional	Code 2	AgNi + 5 μ Au
Rated current	6 A		
Switch-on current max. (20 ms)	15 A		
Switching voltage max	250 V		
AC load (Fig 1)	1,5 kVA		
DC load	see fig. 2		

Coil			
Coil resistance	see table; tolerance ± 10 %		
Pick-up voltage	≤ 0,8 × U _N		
Release voltage	≥ 0,1 × U _N		
Nominal power	1,1 VA (AC)/0,7 W (DC)		

Coil table	VAC	Ω	mA	VDC	Ω	mA
	24	290	45	12	224	53
	48	1200	23	24	742	32
	115	7.300	9,5	48	3.500	13,7
	230	28.800	4,7	110	19.900	5,5

Insulation	Volt rms, 1 min
Contact open	1000 V
Contact/coil	5 kV
Insulation resistance at 500 V	≥ 1 GΩ
Insulation, IEC 61810-1	4 kV/3

Specifications	
Ambient temperature operation/storage	-40 (no ice)...70 °C /-40 ... 80 °C
Pick-up time/bounce time	10 ms/≤ 1 ms
Release time/bounce time	5 ms/≤ 3 ms
Mechanical life ops	AC: 10 Mill./DC: 20 Mill.
DC voltage endurance at rated load	≥ 100000 switching cycles
Switching frequency at rated load	1200/h
Protection class	IP40
Weight	21 g

Standard types		
VAC 50 Hz/60 Hz: 24, 48, 115 (120), 230 (240)	C10-T11/AC ... V	C10-T12/AC ... V
LED	C10-T11X/AC ... V	C10-T12X/AC ... V
RC suppresor	C10-T11R/AC...V	C10-T12R/AC...V
VDC12, 24, 48, 110	C10-T11/DC ... V	C10-T12/DC ... V
LED	C10-T11X/DC ... V	C10-T12X/DC ... V
Polarity and free wheeling diode	C10-T11FX/DC ... V	C10-T12FX/DC ... V
AC/DC bridge rectifier 24 V, 48 V	C10-T11BX/UC ... V	C10-T12BX/UC ... V

"..." Enter the voltage for full type designation

Accessories	
Socket:	S10, S10-P



Connection diagram

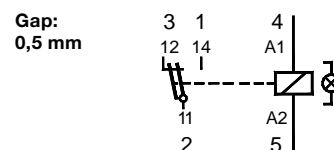


Fig. 1 AC voltage endurance

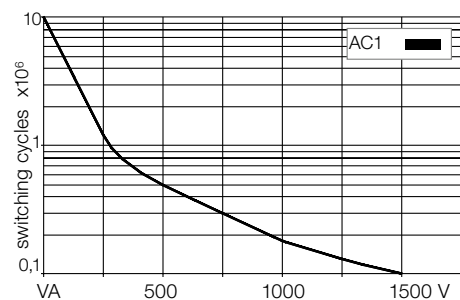
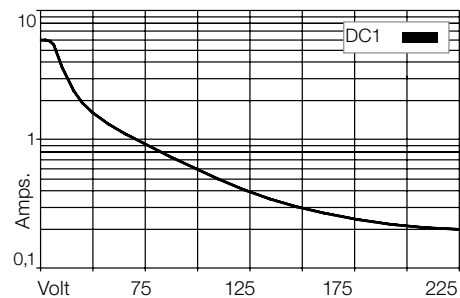
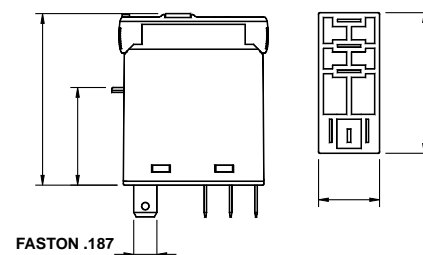


Fig. 2 DC load limit curve



Dimensions [mm]



Technical approvals, conformities



IEC 61810; EN 60947

IRC series
C10-GT1x

4-pin, **Interface relays, 1-pole, twin open contact, plug-in faston**

Type	C10-GT1x/ ... V Standard relay for low power application 1 open contact			
Maximum contact load	6 A/250 V AC1	0,8 A/110 V DC1		
Recommended minimum contact load	6 A/30 V DC1	0,4 A/220 V DC1		
	5 mA/5 V Code 3			
	1 mA/5 V Code 2			

Contacts				
Material	Standard	Code 3	AgNi + 3 μ	
	Optional	Code 2	AgNi + 10 μ Au	
Rated current	6 A			
Switch-on current max. (20 ms)	15 A			
Switching voltage max	250 V			
AC load (Fig 1)	1,5 kVA			
DC load	see Fig. 2			

Coil				
Coil resistance	see table; tolerance ± 10 %			
Pick-up voltage	≤ 0,8 x U _N			
Release voltage	≥ 0,1 x U _N			
Nominal power	1,1 VA (AC)/0,7 W (DC)			

Coil table					
VAC	Ω	mA	VDC	Ω	mA
24	290	45	12	224	53
48	1200	23	24	742	32
115	7.300	9,5	48	3.500	13,7
230	28.800	4,7	110	19.900	5,5

Insulation		Volt rms, 1 min
Contact open	2000 V	
Contact/coil	5 kV	
Insulation resistance at 500 V	≥ 1 GΩ	
Insulation, IEC 61810-1	4 kV/3	

Specifications	
Ambient temperature operation/storage	-40 (no ice)...70 °C /-40 ... 80 °C
Pick-up time/bounce time	10 ms/≤ 1 ms
Release time/bounce time	5 ms/≤ 3 ms
Mechanical life ops	AC: 10 Mill./DC: 20 Mill.
DC voltage endurance at rated load	≥ 100000 switching cycles
Switching frequency at rated load	≤ 1200/h
Protection class	IP40
Weight	21 g

Standard types		
VAC 50 Hz/60 Hz: 24, 48, 115, (120), 230, (240)	C10-GT13/AC ... V	C10-GT12/AC ... V
LED	C10-GT13X/AC ... V	C10-GT12X/AC ... V
RC suppresor	C10-GT13R/AC ... V	C10-GT12R/AC ... V
VDC 12, 24, 48, 110	C10-GT13/DC ... V	C10-GT12/DC ... V
LED	C10-GT13X/DC ... V	C10-GT12X/DC ... V
Polarity and free wheeling diode	C10-GT13FX/DC ... V	C10-GT12FX/DC ... V
AC/DC bridge rectifier 24 V, 48 V	C10-GT13BX/UC ... V	C10-GT12BX/UC ... V

"..." Enter the voltage for full type designation

Accessories	
Socket:	S10, S10-M, S10-P



Connection diagram

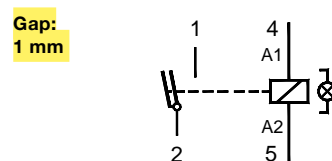


Fig. 1 AC voltage endurance

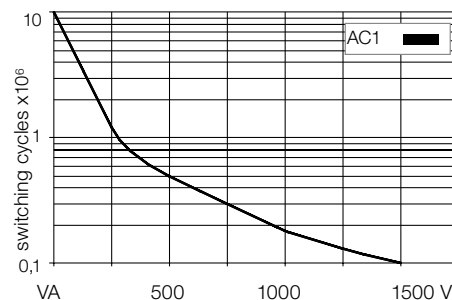
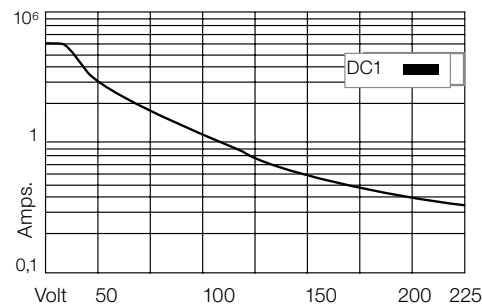
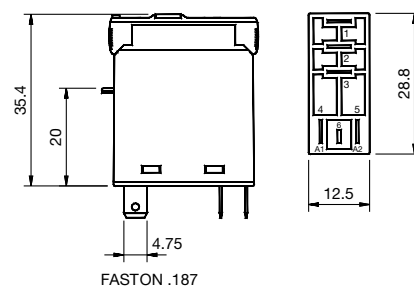


Fig. 2 DC load limit curve



Dimensions [mm]



Technical approvals, conformities



IEC 61810; EN 60947

Type	C12-A2x/ ... V Standard relay 2 change-over contact		
Maximum contact load	5 A/250 V AC1	0,5 A/110 V DC1	
	5 A/30 V DC1	0,2 A/220 V DC1	
Recommended minimum contact load	10 mA/10 V Code 1		
	5 mA/5 V Code 2		

Contacts			
Material	Standard	Code 1	AgNi + 0,2 μ Au
	Optional	Code 2	AgNi + 10 μ Au
Rated current	5 A		
Switch-on current max. (20 ms)	15 A		
Switching voltage max.	250 V		
AC load (Fig 1)	1,2 kVA		
DC load	see fig. 2		

Coil			
Coil resistance	see table; tolerance ± 10 %		
Pick-up voltage	≤ 0,8 × U _N		
Release voltage	≥ 0,1 × U _N		
Nominal power	1,1 VA (AC)/0,7 W (DC)		

Coil table					
VAC	Ω	mA	VDC	Ω	mA
24	290	45	12	224	53
48	1200	23	24	742	32
115	7.300	9,5	48	3.500	13,7
230	28.800	4,7	110	19.900	5,5

Insulation	Volt rms, 1 min
Contact open	1000 V
Contact/contact	3000 V
Contact/coil	5 kV
Insulation resistance at 500 V	≥1 GΩ
Insulation, IEC 61810-1	4 kV/3

Specifications	
Ambient temperature operation/storage	-40 (no ice)...60 °C /-40 ... 80 °C
Pick-up time/bounce time	10 ms/≤ 1 ms
Release time/bounce time	5 ms/≤ 3 ms
Mechanical life ops	AC: 10 Mill./DC: 20 Mill.
DC voltage endurance at rated load	≥100000 switching cycles
Switching frequency at rated load	≤ 1200/h
Protection class	IP40
Weight	21 g

Standard types		
VAC 50 Hz/60 Hz: 24, 48, 115 (120), 230 (240)	C12-A21/AC ... V	C12-A22/AC ... V
LED	C12-A21X/AC ... V	C12-A22X/AC ... V
RC suppressor	C12-A21R/AC ... V	C12-A22R/AC ... V
VDC 12, 24, 48, 110	C12-A21/DC ... V	C12-A22/DC ... V
LED	C12-A21X/DC ... V	C12-A22X/DC ... V
Polarity and free wheeling diode	C12-A21FX/DC ... V	C12-A22FX/DC ... V
AC/DC bridge rectifier 24 V, 48 V	C12-A21BX/UC ... V	C12-A22BX/UC ... V

"..." Enter the voltage for full type designation

Accessories	
Socket:	S12, S12-P



Connection diagram

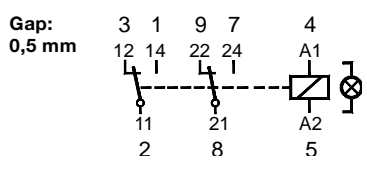


Fig. 1 AC voltage endurance

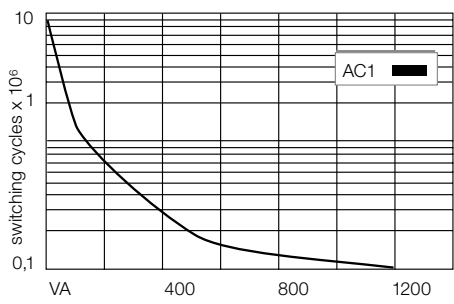
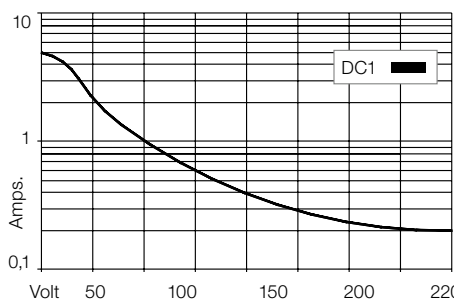
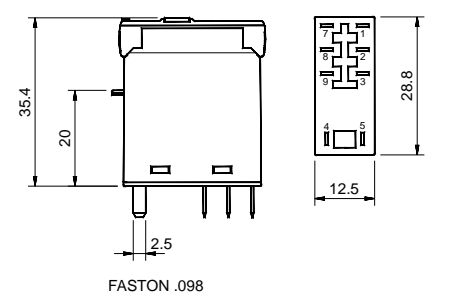


Fig. 2 DC load limit curve



Dimensions [mm]



Technical approvals, conformities

IEC 61810; EN 60947

Type	C12-G2x/ ... V Standard relay 2 open contacts			
Maximum contact load	5 A/250 V AC1	0,8 A/110 V DC1		
	5 A/30 V DC1	0,4 A/220 V DC1		
Recommended minimum contact load	10 mA/10 V Code 1 5 mA/5 V Code 2			

Contacts				
Material	Standard	Code 1	AgNi + 0,2 μ Au	
	Optional	Code 2	AgNi + 10 μ Au	
Rated current	5 A			
Switch-on current max. (20 ms)	15 A			
Switching voltage max.	250 V			
AC load (Fig 1)	1,2 kVA			
DC load	see Fig. 2			

Coil				
Coil resistance	see table; tolerance ± 10 %			
Pick-up voltage	≥ 0,8 x U _N			
Release voltage	≥ 0,1 x U _N			
Nominal power	1,1 VA (AC)/0,7 W (DC)			

Coil table					
VAC	Ω	mA	VDC	Ω	mA
24	290	45	12	224	53
48	1200	23	24	742	32
115	7.300	9,5	48	3.500	13,7
230	28.800	4,7	110	19.900	5,5

Insulation		Volt rms, 1 min
Contact open	2000 V	
Contact/contact	3000 V	
Contact/coil	5 kV	
Insulation resistance at 500 V	≥ 1 GΩ	
Insulation, IEC 61810-1	4 kV/3	

Specifications	
Ambient temperature operation/storage	-40 (no ice)...60 °C /-40 ... 80 °C
Pick-up time/bounce time	10 ms/≤ 1 ms
Release time/bounce time	5 ms/≤ 3 ms
Mechanical life ops	AC: 10 Mill./DC: 20 Mill.
DC voltage endurance at rated load	≥ 100000 switching cycles
Switching frequency at rated load	≤ 1200/h
Protection class	IP40
Weight	21 g

Standard types		
VAC 50 Hz/60 Hz: 24, 48, 115, (120), 230, (240)	C12-G21/AC ... V	C12-G22/AC ... V
LED	C12-G21X/AC ... V	C12-G22X/AC ... V
RC suppressor	C12-G21R/AC ... V	C12-G22R/AC ... V
VDC 12, 24, 48, 110	C12-G21/DC ... V	C12-G22/DC ... V
LED	C12G21X/DC ... V	C12-G22X/DC ... V
Polarity and free wheeling diode	C12-G21FX/DC ... V	C12-G22FX/DC ... V
AC/DC bridge rectifier 24 V, 48 V	C12-G21BX/UC ... V	C12-G22BX/UC ... V

"..." Enter the voltage for full type designation

Accessories	
Socket:	S12, S12-P



Connection diagram

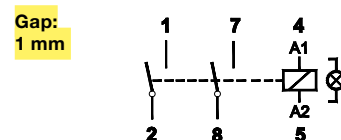


Fig. 1 AC voltage endurance

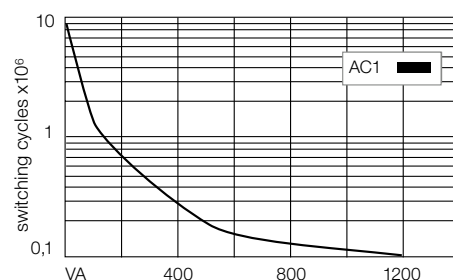
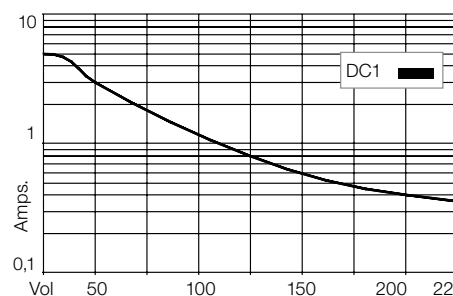
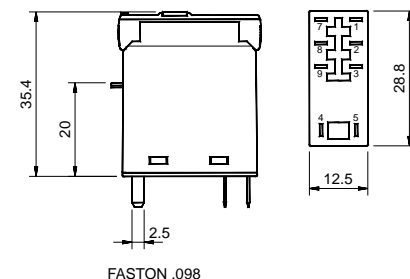


Fig. 2 DC load limit curve



Dimensions [mm]



Technical approvals, conformities



IEC 61810; EN 60947

1.1.4 Solid State Relays

CSS Series

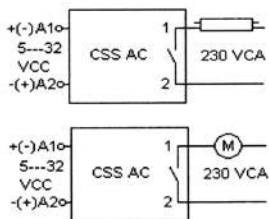


Application	Types	Pins	Contacts	AC ratings	DC ratings	Socket
CSS Series						
AC Solid state relay, Instantaneous switching	CSS-AC			3 A / 250 V		S10
AC Solid state relay synch. to zero crossing	CSS-AZ			3 A / 250 V		S10
NPN Solid state relay	CSS-DCN				2 A / 50 V	S10
PNP Solid state relay	CSS-DCP				2 A / 50 V	S10

Type	CSS-AC Solid state relay For switching resistive and inductive AC loads Instantaneous
Output	1 N/O contact
Operating range	3 A, 24 ... 250 VAC, 50/60 Hz
Minimum contact load	50 mA
Control circuit	
Input voltage range	5 ... 32 VDC
Release voltage	< 2,5 VDC
Input current	5 ... 15 mA
Stabilised current regulator	yes
Input voltage protection	IEC-1000-4-5 level 1
Output circuit	Instantaneous
Max. output current	3 A
Min. output current	50 mA
Output voltage range	24...250 VAC
Inrush current	30 A/10 ms
Max. release voltage	< 1,5 VAC
Residual current	≤ 0,55 mA
di / dt	≤ 50 A / μs
I ² t value	50 A ² s
Specifications	
Ambient temperature operation/storage	-25 ... 60 °C / -40 ... 80 °C
Test voltage between input/output	4 kV rms/1min
Pick-up time	max. 1/2 wave
Release time	2 ms + 1/2 wave
Weight	28 g

Applications

It is specially suitable to switch inductive loads up to 3A/250 VAC. For switching loads with a high inrush or overcurrent (max. Di/dt 50A/μs) as transformers, motors or fluorescents, the maximum output current will limit to 2 A.

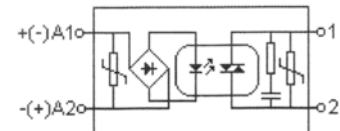


Accessories

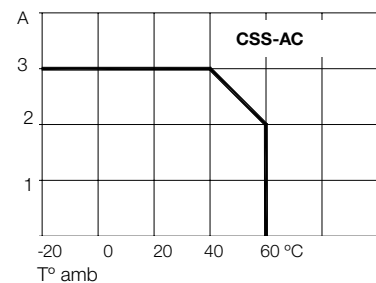
Socket: **S10, S10-M, S10-P**



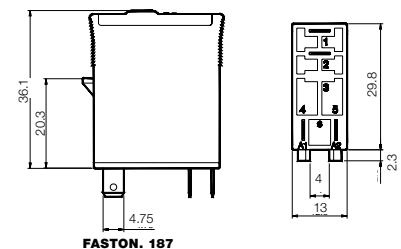
Fig. 1 CSS-AC diagram



Tab. 2 AC derating curve



Dimensions [mm]



Technical approvals, conformities

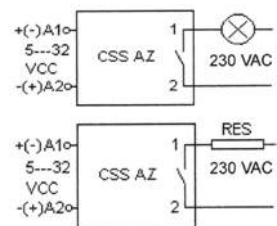


Type	CSS-AZ Solid state relay For switching resistive lamps and AC loads Synchronized to zero crossing
Output	1 N/O contact
Operating range	3 A, 24 ... 250 VAC, 50/60 Hz
Minimum contact load	50 mA
Control parameters	
Input voltage range	5 ... 32 VDC
Release voltage	< 2,5 VDC
Input current	5 ... 15 mA
Stabilised current regulator	yes
Input voltage protection	IEC-1000-4-5 Level 1

Output	Synchronized zero
Max. output current	3 A
Min. output current	50 mA
Output voltage range	24 ... 250 VAC
Inrush current	30 A/10 ms
Max. release voltage	< 1,5 VAC
Residual current	≤ 0,55 mA
di / dt	≤ 50 A / μs
I ² t value	50 A ² s

Specifications	
Ambient temperature operation/storage	-25...60 °C / -40 ... 80 °C
Test voltage between input/output	4 kV rms/1min
Pick-up time	max. 1/2 cycle
Release time	2 ms + 1/2 cycle
Weight	28 g

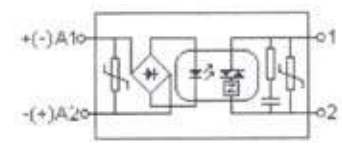
Applications
Switches ohmic AC loads up to 3 A/250 VAC in the zero-point of the tension and avoids any overcurrent peak in the connection.
Suitable for switching resistors, incandescent lamps, signalling equipment, etc. Not suitable for inductive loads



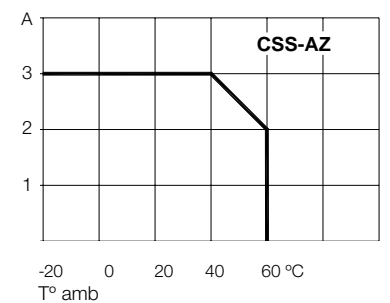
Accessories
Socket: **S10, S10-M, S10-P**



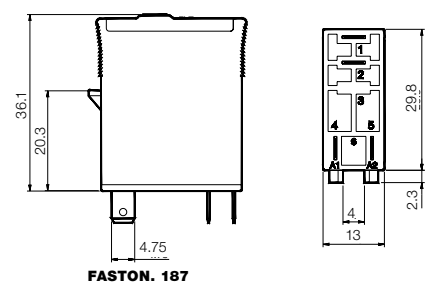
Fig. 1 CSS-AZ diagram



Tab. 2 AC derating curve



Dimensions [mm]



Technical approvals, conformities



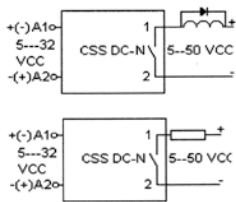
4-pin, **Interface solid state relay**, 1-pole, plug-in faston

Type	CSS-DCN NPN solid state relay Terminal commun 2 negative (S10 socket)
Output	1 N/O contact
Operating range	2 A, 5 ... 50 VDC
Minimum contact load	1 mA
Control parameters	
Input voltage range	5 ... 32 VDC
Release voltage	< 2,5 VDC
Input current	3 ± 1 mA
Stabilised current regulator	yes
Input voltage protection	IEC-1000-4-5 Level 1
Output	
Type	NPN
Max. output current	2 A
Output voltage range	5 ... 50 VDC
Switch-on current max.	5 A/ 350µs
Max. voltage drop	≤ 1,3 VDC
Residual current	< 100 µA/48 VDC
EMC protection	IEC-1000-4-5 Level 1
Inverse current	≤ 1 A
Specifications	
Ambient temperature operation/storage	-25 ... 60 °C/-40 ... 80 °C
Test voltage between input/output	4 kV rms/1 min.
Turn-on delay	1 ms
Release delay	≤ 2 ms
Weight	28 g

Applications

For switching heating elements, electro valves, motors, PLC input/output signals, solenoids, incandescent and fluorescent lamps, etc. (up to 50 VDC).

Inductive loads must be shunted with an antiparallel diode.

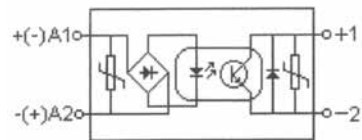


Accessories

Socket: **S10, S10-M, S10-P**

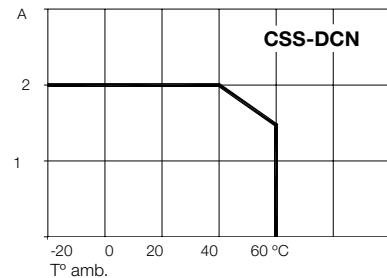


Fig. 1 CSS-DCN diagram

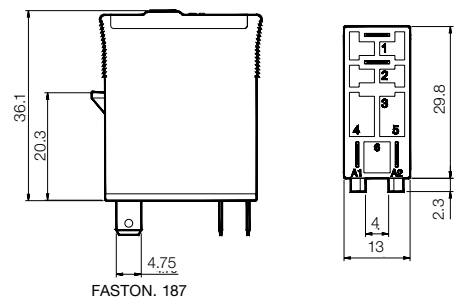


Negative common

Tab. 2 DC derating curve



Dimensions [mm]



Technical approvals, conformities



IRC series
CSS-DCP

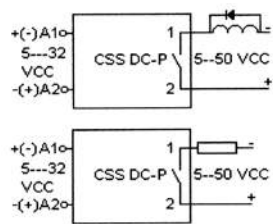
4-pin, **Interface solid state relay**, 1-pole, plug-in faston

Type	CSS-DCP PNP solid state relay Terminal commun 2 positive (S10 socket)
Output	1 N/O contact
Operating range	2 A, 5 ... 50 VDC
Minimum contact load	1 mA
Control parameters	
Input voltage range	5 ... 32 VDC
Release voltage	< 2,5 VDC
Input current	3 ± 1 mA
Stabilised current regulator	yes
Input voltage protection	IEC-1000-4-5 Level 1
Output	
Type	PNP
Max. output current	2 A
Output voltage range	5 ... 50 VDC
Max. switch-on current	5 A / 350µs
Max. voltage drop	≤ 1,3 VDC
Residual current	< 100 µA/48 VDC
EMC protection	IEC-1000-4-5 Level 1
Inverse current	≤ 1 A
Specifications	
Ambient temperature operation/storage	-25...60 °C / -40 ... 80 °C
Test voltage between input/output	4 kV rms/1 min.
Turn-on delay	1 ms
Release delay	≤ 2 ms
Weight	28 g

Applications

For switching heating elements, electro valves, motors, PLC input/output signals, solenoids, incandescent and fluorescent lamps, etc. (up to 50 VDC).

Inductive loads must be shunted with an antiparallel diode.

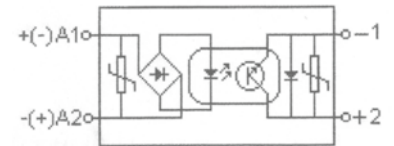


Accessories

Socket: **S10, S10-M, S10-P**

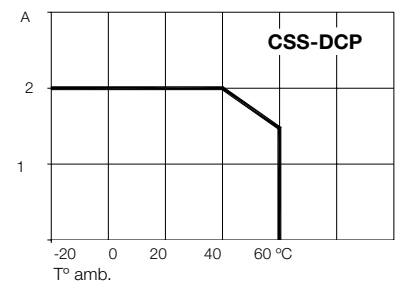


Fig. 1 CSS-DCP diagram

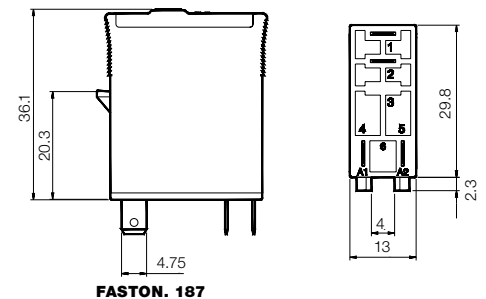


Positive common

Tab. 2 DC derating curve



Dimensions [mm]



FASTON. 187

Technical approvals, conformities



In combination with I/O sockets and the plug-in jumpers, the IRC relay series permits low-cost, clearly arranged and reliable realisation of interface circuits for the input and output ends of PLC and control systems.

S10-M and S12 sockets with one and two contacts, with inputs in series and identical arrangement of the contacts.

Identical order of coil and contacts on both sockets.

Coil terminal at level 1:

(A2, A2, A1)

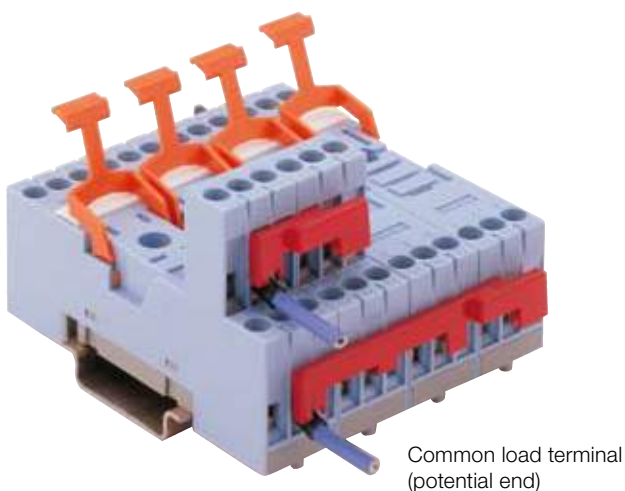
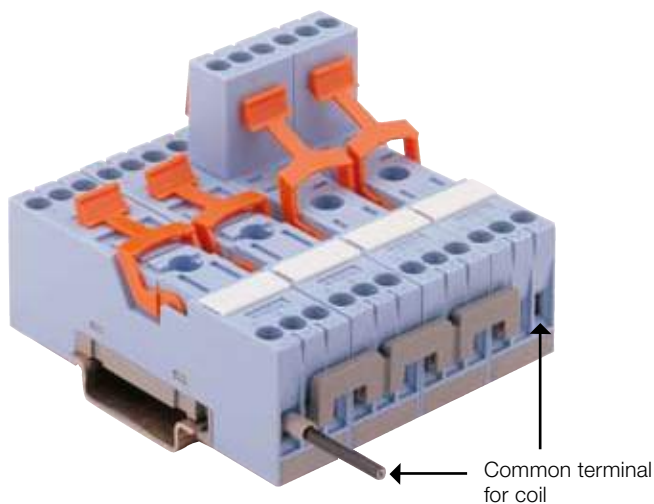
Power terminals at level 1:

(12, 11, 14)

Power terminals at level 2:

(22, 21, 24)

General



All plug-in jumpers are insulated. The plug-in jumpers at the drive end (coil) can be split manually to the required length, thus enabling the creation of any required interface groups.

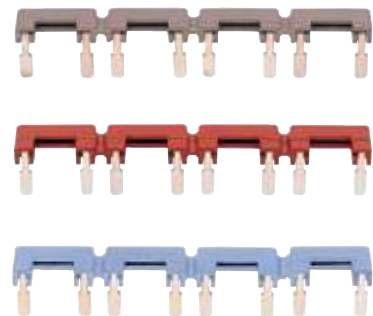
The jumpers are available in the colours grey, blue and red. .

Options:

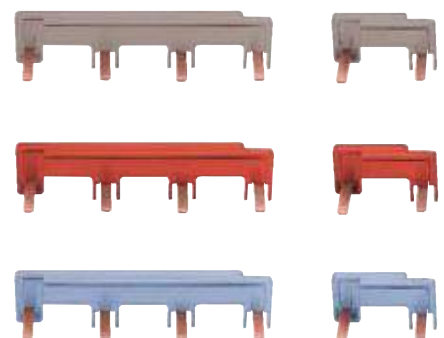
Colours used by RELECO in the relays' test buttons:

- Blue for DC circuits
- Red for AC circuits

B20 plug-in jumpers for the control end



V40 and V10 plug-in jumpers for the power end



V40, V10

Power bridge bars for sockets S10-M and S12

V40 bridges join four similar points in four aside adjacent sockets. They can join up either among themselves or to V10 units, to bridge an unlimited number of sockets S10-M and S12 in any combination.

V10 bridges are units to connect a single socket to the next one, so you bridge less or more than 4 sockets.

Made of copper with a current capacity of 40 A.

B20

Coil bridge bars for sockets S10-M and S12

B20 bridges points A2, internally connected, of every aside adjacent socket S10-M or S12.

Each element connects point 6 of the first socket to point 5 of the next one, always leaving free the point 5 of the first socket and the point 6 of the last one, to connect the common polarity cable.

V40-G



V10-G



B20-G



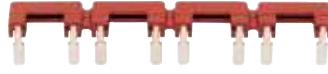
V40-R



V10-R



B20-R



V40-A



V10-A



B20-A



Jumper connection on S10-M and S12 sockets

The S10-M and S12 sockets and the new connection jumpers B20, V10 and V40 enable easy and fast wiring of rows of relays. The jumpers can be used in a mixed configuration of S10-M and S12 sockets.

Different jumper colours allow clear identification. This results in fewer errors, lower assembly costs and easier inspection and maintenance work. Available in grey (standard), red (AC) and blue (DC), in conformity with the colour coding used by RELECO for test buttons for relay identification.

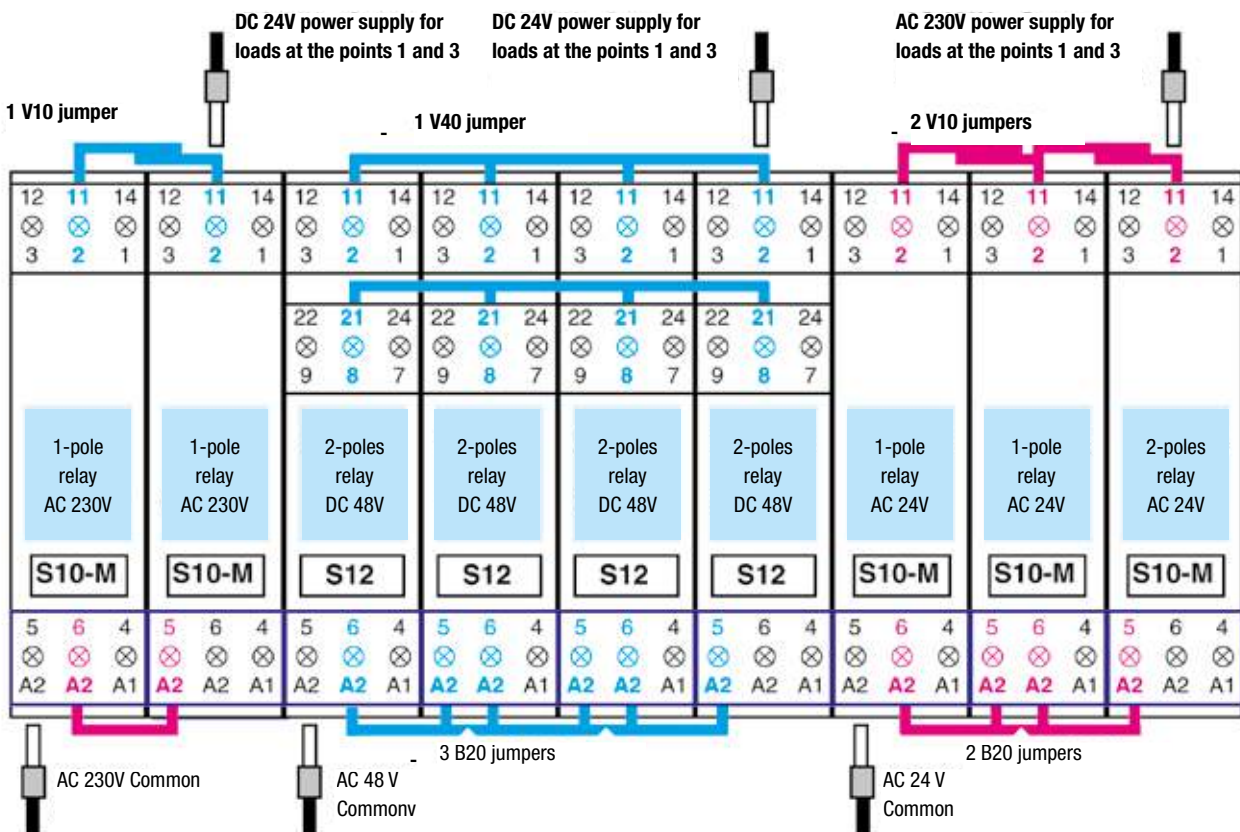
Attention needs to be paid only to the total current. At higher currents and also for safety reasons, a current supply at the start and end of a jumpered connection is recommended.

V40 plug-in jumpers for the power end

Contacts can be linked to the power ends with the aid of these jumpers. Normally, these are the changeover contacts, terminal 11 or 21. The jumpers can also be used to jumper NC or NO plug-in terminals. V40 jumpers link four identical contacts of four neighbouring sockets. They can either be linked to one another or to V10 jumpers to jumper a number of sockets in any combination.

V10 plug-in jumpers for the power end

V10 jumpers can be used to link individual sockets to one another in groups. A combination of V40 and V10 jumpers is possible, depending on the number of sockets.



B20 plug-in jumpers for the control end
The sockets S10-M and S12 are accessible via the plug-in terminals 5 and 6 for A2 (internal connection). Each element links terminal 6 of the first socket

to 5 of the next socket, and 5 of the first socket and 6 of the last socket are always left free to connect the cable. The jumper B20 consists of four coherent parts, which can be separated, however.

Input

Application

The CSS semiconductor switches have a useful life that is practically unlimited in terms of switching cycles. They operate without bounce and permit a high switching frequency

Drive

All versions feature an electrically isolated input for 5 to 32 V DC. The inputs are characterised by a minimum delay with a simultaneously high interference immunity.

DC semiconductor switches

There are two versions with identical performance data.

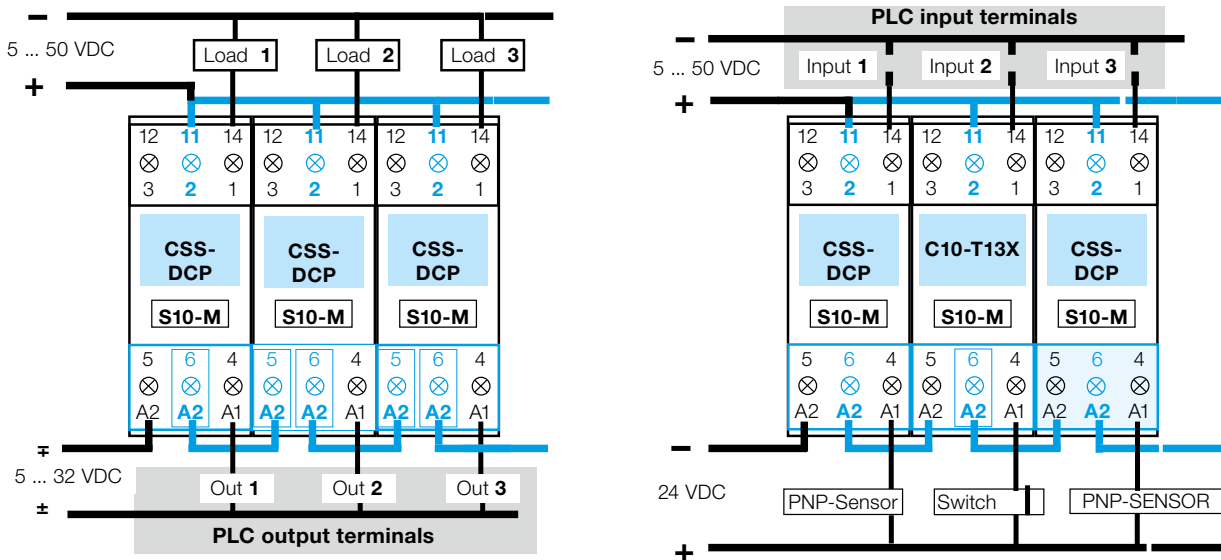
The CSS-DCN version has the common negative terminal 2, and the load is connected to terminal 1. The CSS-DCP has the common positive terminal at terminal 2. The load is connected to terminal 1. This corresponds to an NPN or PNP switch.

AC switches

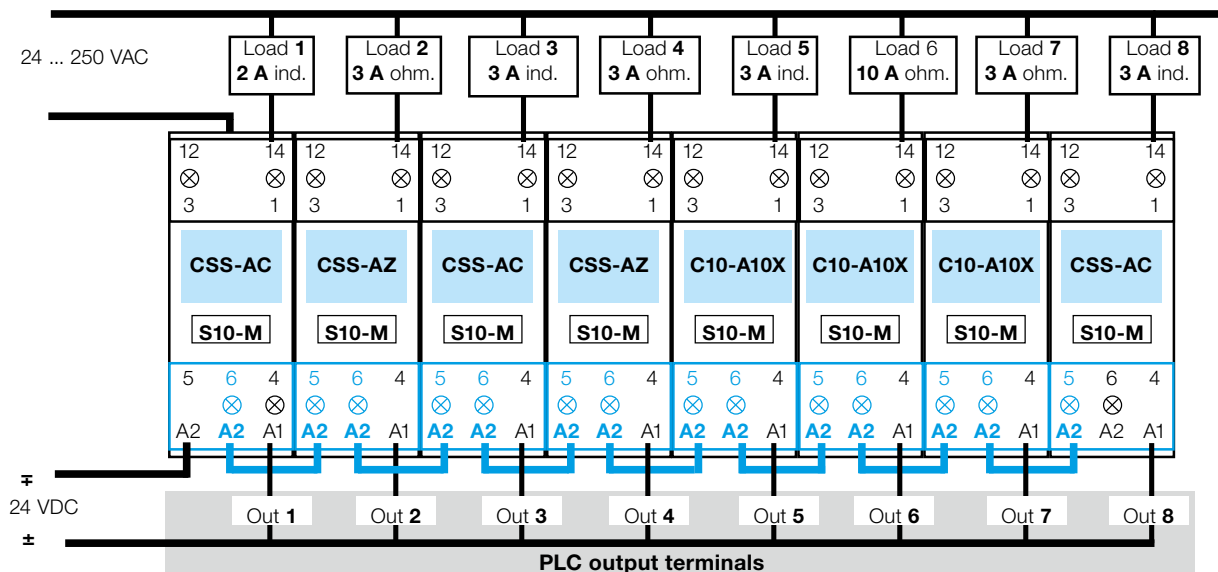
The CSS-AZ version switches synchronously, i.e. it switches during the passage through zero. The CSS-AC version switches asynchronously, i.e. the semiconductor switch switches through, independently of the phase, at the moment of detected triggering.

DC applications with mixed components

DC applications with mixed components

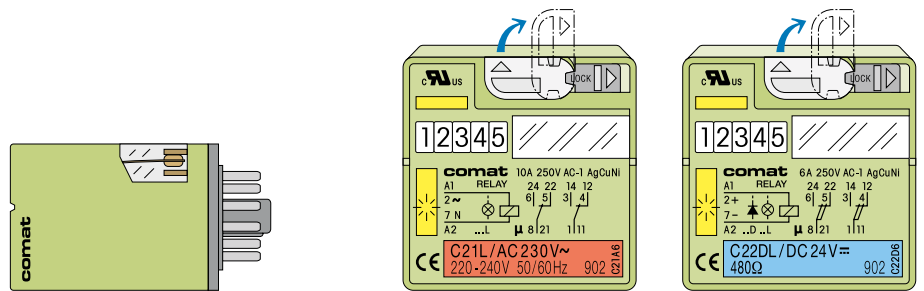


AC applications with mixed components



1.1.5 Long Life Relays (Railway)

Long Life Series



Application	Types	Pins	Contacts	Contact ratings	Socket
C20 Series					
Long Life standard	C21			10 A / 250 V	S2
Long Life, reliable switching of lower loads	C22			5 A / 250 V	S2
C30 Series					
Long Life, Railway	C31			10 A / 250 V	S3
Long Life, reliable switching of lower loads, Railway	C32			5 A / 250 V	S3

C21 with single contacts

8 pin plug-in relay, 2-pole, according to IEC 67-I-5a

Type	C21/...V Long Life Relay 2 change over contacts Types with LED status indicator Types with free wheeling diode Manual actuator and mech. status indicator
-------------	---

Maximum contact load	10 A / 250 V AC-1, 4 A / 440 V AC-1 10 A / 30 V DC-1
-----------------------------	---

Recommended minimum contact load	50 mA / 10 V
---	---------------------

Contacts	single contact micro disconnection
Type	AgCuNi
Material	10 A
Rated operational current	40 A
Max. inrush current (20 ms)	250 V / 440 V
Rated/Max. switching voltage AC-1	2500 VA AC-1
Max. AC load	300 W / 90 W
Max. DC load 30 V / 230 V DC-1 (Fig. 2)	

Coils (Values are valid at 20 °C)	
Pick-up voltage	$\leq 0.8 \times V_N$
Release voltage AC / DC	$> 0.15 \times V_N / > 0.05 \times V_N$
Nominal power AC / DC	2.5 VA / 1.2 W

Coil Table

V_N AC	Ω	mA	V_N DC	Ω	mA
24	52	104	12	115	104
48	240	55	24	480	50
115	1350	23	48	1850	26
230	5600	11.5	110	9000	12
			220	29000	7.6

Types with LED indicator take additional 5 ... 10 mA @ < 80 V

Insulation	
Test voltage open contact	1.5 kVrms, 1 minute
Test voltage between adjacent poles	1.5 kVrms, 1 minute
Test voltage between contacts and coil	2 kVrms, 1 minute

General Specifications

Ambient temperature operation, storage	-40 ... +70 °C
Pickup time AC / DC	3 ... 10 ms / ≤ 12 ms
Release time AC / DC	2 ... 15 ms / ≤ 3.5 ms
Bounce time NO contact AC / DC	3 ... 6 ms / approx. 3.5 ms
Mechanical life	$\geq 10^8$ operations
Operating frequency at nominal load	≤ 360 operations / h
Ingress Protection degree	IP 40
Weight	80 g

Standard types

AC 50 Hz / 60 Hz: 24, 48, 115, 230

LED

DC: 12, 24, 48, 110, 220

Free wheeling diode

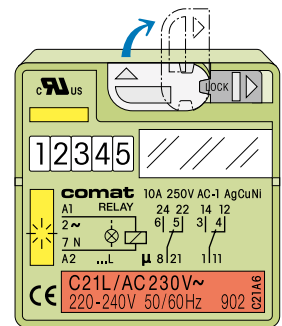
LED + Free wheeling diode

C21/AC...V
C21L/AC...V
C21/DC...V
C21D/DC...V
C21DL/DC...V

"..." enter the voltage for full type designation

Accessories

Socket: **EC-8, S2-B, S2-S, S2-L, S2-P, S2-PO**



Connection diagram

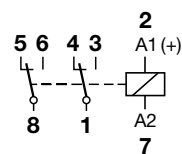


Fig.1 AC voltage endurance

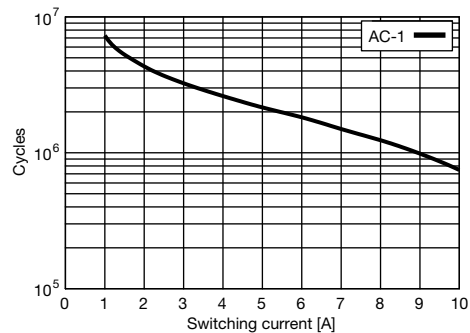
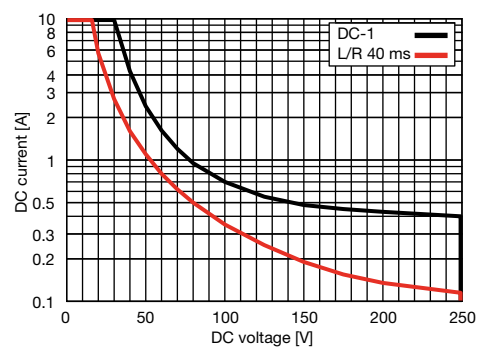
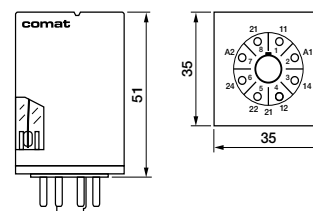


Fig. 2 DC load limit curve



Dimensions [mm]



Technical approvals, conformities



Long life series

C22 with double contacts

8 pin plug-in relay, 2-pole, according to IEC 67-I-5a

Type	C22/...V Long Life Relay 2 change over double contacts Types with LED status indicator Types with free wheeling diode Manual actuator and mech. status indicator
-------------	--

Maximum contact load	6 A / 250 V AC-1 6 A / 30 V DC-1
Recommended minimum contact load	10 mA / 5 V

Contacts	
Type	double contact micro disconnection
Material	AgCuNi
Rated operational current	6 A
Max. inrush current (20 ms)	15 A
Max. switching voltage AC-1	250 V
Max. AC load	1500 VA AC-1
Max. DC load 30V / 230V DC-1 (Fig. 2)	200 W / 90 W

Coils (Values are valid at 20 °C)	
Pick-up voltage	$\leq 0.8 \times V_N$
Release voltage AC / DC	$> 0.15 \times V_N / > 0.05 \times V_N$
Nominal power AC / DC	2.5 VA / 1.2 W

Coil Table

V_N AC	Ω	mA	V_N DC	Ω	mA
24	52	104	12	115	104
48	240	55	24	480	50
115	1350	23	48	1850	26
230	5600	11.5	110	9000	12
			220	29000	7.6

Types with LED indicator take additional 5 ... 10 mA @ < 80 V

Insulation	
Test voltage open contact	1.5 kVrms, 1 minute
Test voltage between adjacent poles	1.5 kVrms, 1 minute
Test voltage between contacts and coil	2 kVrms, 1 minute

General Specifications	
Ambient temperature operation, storage	-40 ... +70 °C
Pickup time AC / DC	3 ... 10 ms / ≤ 12 ms
Release time AC / DC	2 ... 15 ms / ≤ 3.5 ms
Bounce time NO contact AC / DC	3 ... 6 ms / approx. 3.5 ms
Mechanical life	$\geq 10^8$ operations
Operating frequency at nominal load	≤ 360 operations / h
Ingress Protection degree	IP 40
Weight	80 g

Standard types

AC 50 Hz / 60 Hz: 24, 48, 115, 230

LED

DC: 12, 24, 48, 110, 220

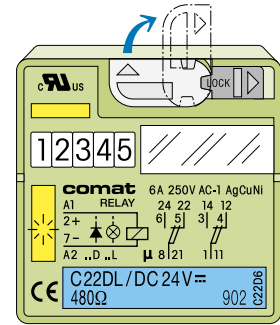
Free wheeling diode

LED + Free wheeling diode

C22/AC...V
C22L/AC...V
C22/DC...V
C22D/DC...V
C22DL/DC...V

"..." enter the voltage for full type designation

Accessories	
Socket:	EC-8, S2-B, S2-S, S2-L, S2-P, S2-PO



Connection diagram

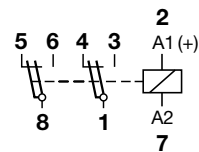


Fig.1 AC voltage endurance

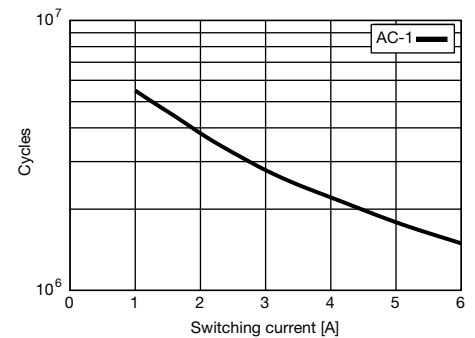
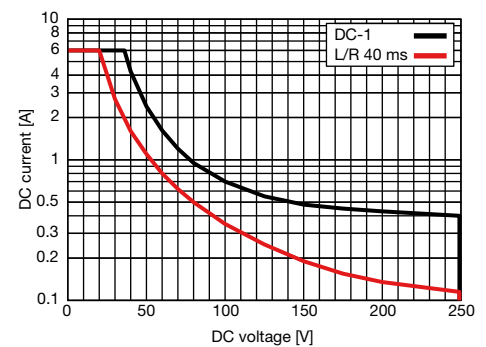
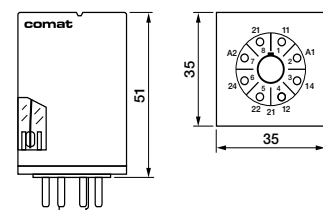


Fig. 2 DC load limit curve



Dimensions [mm]



Technical approvals, conformities



C31 with single contacts

11 pin plug-in relay, 3-pole, according to IEC 67-I-18a



Type **C31/...V**
 Long Life Relay, according to EN 50 155 Railway
 3 change over contacts
 Types with LED status indicator
 Types with free wheeling diode
 Manual actuator and mech. status indicator

Maximum contact load **10 A / 250 V AC-1, 4 A / 440 V AC-1**
10 A / 30 V DC-1
Recommended minimum contact load **50 mA / 10 V**

Contacts
 Type single contact micro disconnection
 Material AgCuNi
 Rated operational current 10 A
 Max. inrush current (20 ms) 40 A
 Rated/max. switching voltage 250 V / 440 V
 Max. AC load 2500 VA AC-1
 Max. DC load 30V / 230V DC-1 (Fig. 2) 300W / 90 W

Coils (Values are valid at 20 °C)
 Pick-up voltage $\leq 0.8 \times V_N$
 Release voltage AC / DC $> 0.15 \times V_N / > 0.05 \times V_N$
 Nominal power AC / DC 2.5 VA / 1.2 W

Coil Table

V_N AC	Ω	mA	V_N DC	Ω	mA
24	52	104	12	115	104
48	240	55	24	480	50
115	1350	23	48	1850	26
230	5600	11.5	110	9000	12
			220	29000	7.6

Types with LED indicator take additional 5 ... 10 mA @ < 80 V

Insulation
 Test voltage open contact 1.5 kVrms, 1 minute
 Test voltage between adjacent poles 1.5 kVrms, 1minute
 Test voltage between contacts and coil 2 kVrms, 1minute

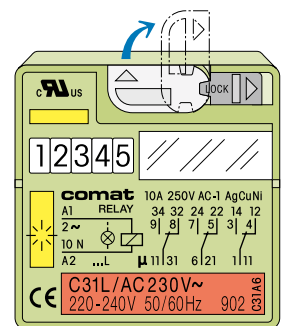
General Specifications
 Ambient temperature operation, storage -40 ... +70 °C
 Pickup time AC / DC 3 ... 10 ms / ≤ 12 ms
 Release time AC / DC 2 ... 15 ms / ≤ 3.5 ms
 Bounce time NO contact AC / DC 3 ... 6 ms / approx. 3.5 ms
 Mechanical life $\geq 10^8$ operations
 Operating frequency at nominal load ≤ 360 operations / h
 Ingress Protection degree IP 40
 Weight 80 g

Standard types
 AC 50 Hz / 60 Hz: 24, 48, 115, 230 (240)
 LED
 DC: 12, 24, 48, 110, 220
 Free wheeling diode
 LED + Free wheeling diode
 Railway EN 50155; NF F 16-101/102

C31/AC...V
C31L/AC...V
C31/DC...V
C31D/DC...V
C31DL/DC...V
C31D/R DC...V

"..." enter the voltage for full type designation

Accessories
 Socket: EC-11, EC11A, S3-B, S3-S, S3-L, S3-P, S3-PO



Connection diagram

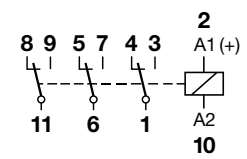


Fig.1 AC voltage endurance

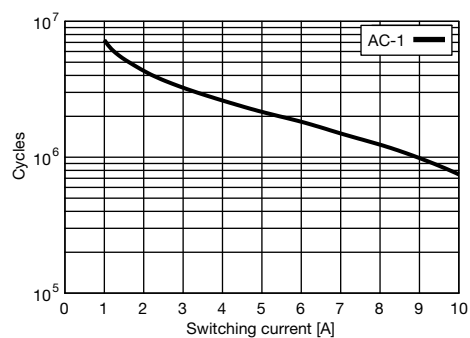
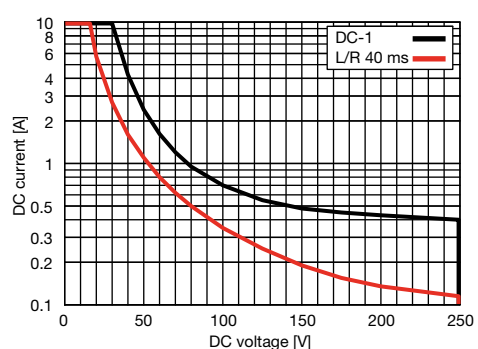
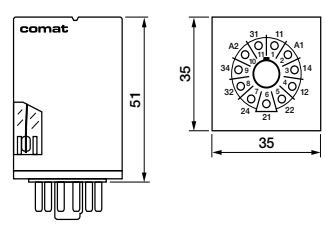


Fig. 2 DC load limit curve



Dimensions [mm]



Technical approvals, conformities



C32 with double contacts

11 pin plug-in relay, 3-pole, according to IEC 67-I-18a



Type	C32/...V Long Life Relay, according to EN 50 155 Railway 3 change over double contacts Types with LED status indicator Types with free wheeling diode Manual actuator and mech. status indicator
-------------	--

Maximum contact load	6 A / 250 V AC-1 6 A / 30 V DC-1
Recommended minimum contact load	10 mA / 5 V

Contacts	
Type	double contact micro disconnection
Rated operational current	6 A
Max. inrush current (20 ms)	15 A
Max. switching voltage AC-1	250 V
Max. AC load	1500 VA AC-1
Max. DC load 30V / 230V DC-1 (Fig. 2)	200 W / 90 W

Coils (Values are valid at 20 °C)	
Pick-up voltage	$\leq 0.8 \times V_N$
Release voltage AC / DC	$> 0.15 \times V_N / > 0.05 \times V_N$
Nominal power AC / DC	2.5 VA / 1.2 W

Coil Table					
V_N AC	Ω	mA	V_N DC	Ω	mA
24	52	104	12	115	104
48	240	55	24	480	50
115	1350	23	48	1850	26
230	5600	11.5	110	9000	12
			220	29000	7.6

Types with LED indicator take additional 5 ... 10 mA @ < 80 V

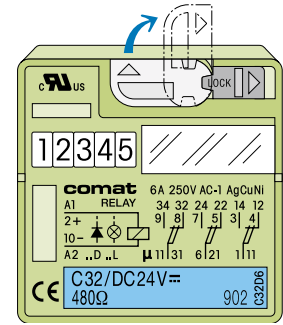
Insulation	
Test voltage open contact	1.5 kVrms, 1 minute
Test voltage between adjacent poles	1.5 kVrms, 1 minute
Test voltage between contacts and coil	2 kVrms, 1 minute

General Specifications	
Ambient temperature operation, storage	-40 ... +70 °C
Pickup time AC / DC	3 ... 10 ms / ≤ 12 ms
Release time AC / DC	2 ... 15 ms / ≤ 3.5 ms
Bounce time NO contact AC / DC	3 ... 6 ms / approx. 3.5 ms
Mechanical life	$\geq 10^8$ operations
Operating frequency at nominal load	≤ 360 operations / h
Ingress Protection degree	IP 40
Weight	80 g

Standard types	
AC 50 Hz / 60 Hz: 24, 48, 115, 230 (240)	C32/AC...V
LED	C32L/AC...V
DC: 12, 24, 48, 110, 220	C32/DC...V
Free wheeling diode	C32D/DC...V
LED + Free wheeling diode	C32DL/DC...V
Railway EN 50155; NF F 16-101/102	C32D/R DC...V

" ..." enter the voltage for full type designation

Accessories	
Socket:	EC-11, EC11A, S3-B, S3-S, S3-L, S3-P, S3-PO



Connection diagram

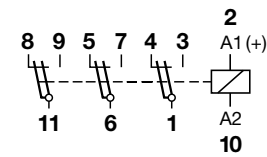


Fig.1 AC voltage endurance

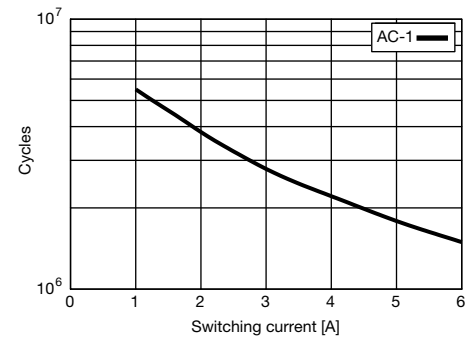
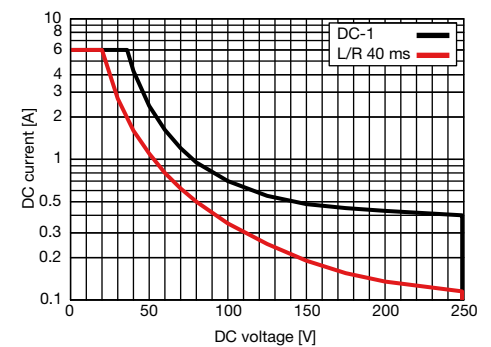
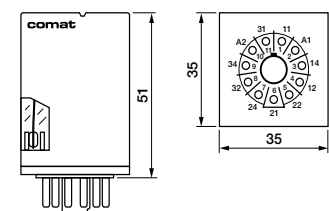


Fig. 2 DC load limit curve



Dimensions [mm]

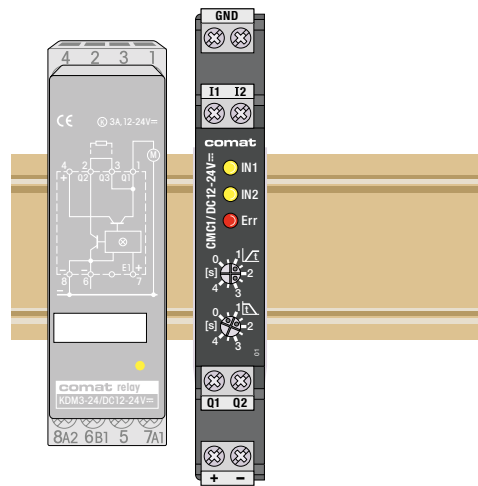




Technical approvals, conformities



1.1.6 Motor Control Relay

DC Motor Control Relay



Application	Types	Output	DC ratings	Mounting
DC Motor controller	CMC1	 2x MOSFET	10 A (20 A) / 24 V	DIN
DC Motor control relay	KDM3-24	 1x PNP & 1x NPN	3 A / 32 V	S7-C

CMC1

DC Motor controller with adjustable start and breaking ramps for DC motors up to 240W

Type: CMC1/DC12-24V

The CMC is a control device for DC motors and permits operation in both rotating directions, i. e. the rotating direction can be reversed with the input signal. Alternatively, two motors can be operated in the same direction.

The CMC1 allows also to control lamps or electromagnets. The start and breaking ramps of the connected loads can be adjusted by two potentiometers in the time range 0 - 4 seconds.

Maximum load **10 A / 24 V**

Outputs	Drive
Type	MOSFET
Nominal switching current	10 A
Inrush current	20 A (short-term)
Nominal voltage	24 V
Switching power	240 W

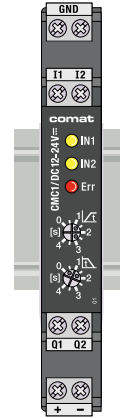
Control input $V_n =$	12-24 V
Nominal operating voltage range (DC)	12 ... 24 V
Admissible voltage range (DC)	8 ... 28 V
Current consumption	DC
12 V	3 mA
24 V	6 mA

Power supply	
Nominal operating voltage (DC)	12 ... 24 V
Operating voltage (DC)	8 ... 28 V
Max. current consumption without load	10 mA
Max. power consumption	DC
12 V	120 mW
24 V	240 mW

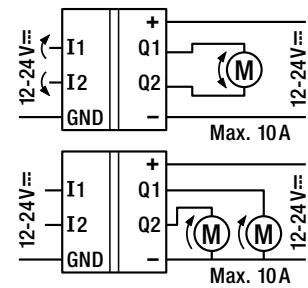
General Specifications	
Ambient temperature storage/operation	-40 ... +85°C / -25 ... +60°C
Connection terminals	Screw terminal 2.5 mm ²
DC voltage endurance at rated load	> 100 000 h (at 25 °C)
Ingress protection degree	IP 20
Mounting	DIN rail TS35
Housing material	Aluminium
Weight	80 g

Standard types

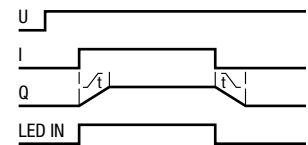
DC 12-24 **CMC1/DC12-24V**



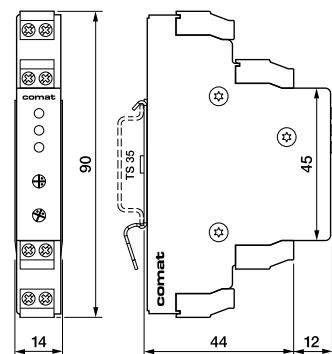
Connection diagram



Function diagramm



Dimensions [mm]



Technical approvals, conformities



KDM 3-24

DC Motor control relay with brake function, DC 24 V 1 high side switch and 1 N-channel brake switch

Type: KDM 3-24/DC12-24V R

Solid state relay for DC-motor control and similar applications

1 high side + 1 N channel transistor switch

All overload and short circuit protected

Adjustable or disabled brake function by

external resistor or jumper

LED status indicator

Pluggable module

Maximum load **3 A / 32 V**

Outputs

Type: Power MOS FET

Max. switching current

Max. continuous current

Max. inrush current, 1 sec ²⁾

Switching voltage range

Max. Load

Thermal overload protection ²⁾

Over current limiting ²⁾

Clamp voltage

Max. inductive switch-off energy ²⁾

ON resistance @ 25 °C

Leakage current

Drive

High side

3 A

3 A (5 A) ¹⁾

20 A

10 ... 32 V

100 W

self restoring

typ. 35 A

typ. 58 V

1 Ws single pulse

≤ 50 mΩ

≤ 10 μA

Brake

N-channel

3 A, 10 sec

2 A

7

10 ... 32 V

65 W

self restoring

7 ... 14 A

60 ... 70 V

0.4 Ws single pulse

≤ 100 mΩ

¹⁾ Repetitive operation: When the ratio t_{pulse} / t_{cycle} is a low value then the current can be increased up to 5 A @ $T_A \leq 50$ °C.

²⁾ Not for continuous repetitive operation

Control input $V_N =$

Operating voltage range

Release voltage

Typical input current @ 12 / 24 V

Power consumption @ 12 / 24 V

Polarity reversal

DC 12-24 V

9 ... 28 V

≤ 2 V

2 / 6.5 mA

25 / 160 mW

protected

General Specifications

Ambient temperature storage/operation

ON delay

Release time

Ingress protection degree

Housing material

Weight

-40 ... +85°C / -25 ... +60°C

1 ms

1 ms

IP 40 when the device is plugged in

Lexan

27 g

Standard types

DC 12-24

KDM3-24/DC12-24V R

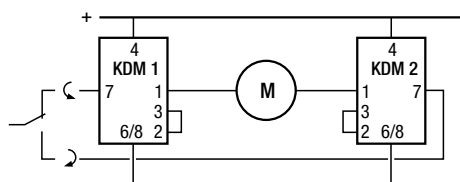
Accessories

Socket:

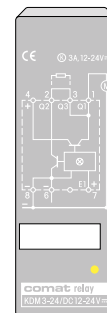
S7-C

Application example

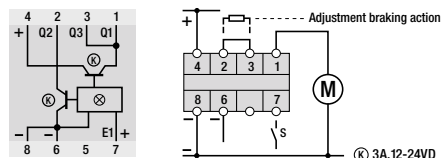
Four quadrant (forward / reversed) motor control



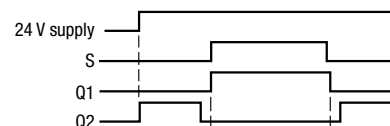
Operating with brake resistors (on 2-3) is not recommended in this application.



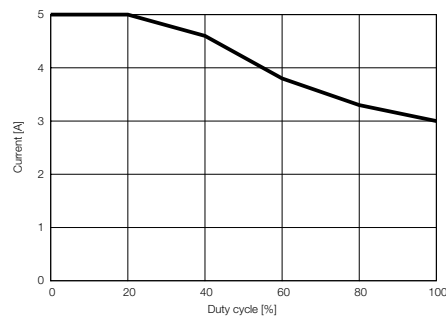
Connection diagram



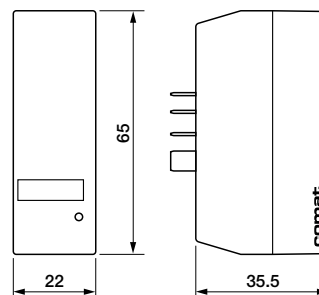
Function diagramm



Output current vs. duty cycle



Dimensions [mm]



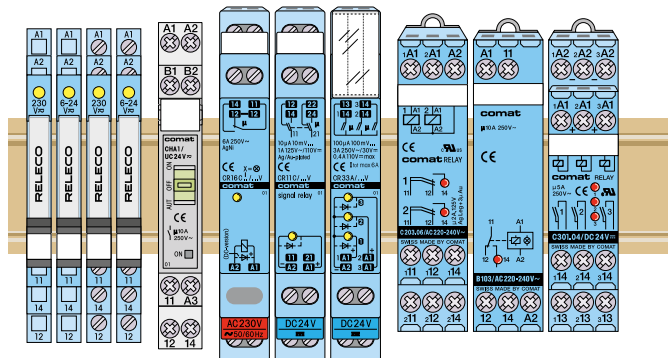
Technical approvals, conformities



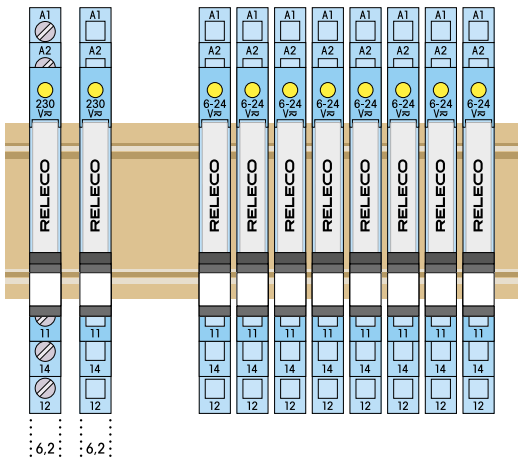
1.2 DIN Relays

1.2.1 Interface Relays

DIN Relays



Application	Types	Size	Outputs	AC ratings	DC ratings	Connections
Interface relay for PLC, power contact	RINT-11	6.2 mm		6 A / 250 V	6 A / 25 V	Screw type
Interface relay for PLC, power contact	RINT-21	6.2 mm		6 A / 250 V	6 A / 25 V	Cage clamp type
Interface relay for PLC, signal contact	RINT-12	6.2 mm		6 A / 250 V	6 A / 25 V	Screw type
Interface relay for PLC, signal contact	RINT-22	6.2 mm		6 A / 250 V	6 A / 25 V	Cage clamp type
Interface relay for PLC, DC-solid state contact	RINT-15	6.2 mm			2 A / 33 V	Screw type
Interface relay for PLC, DC-solid state contact	RINT-25	6.2 mm			2 A / 33 V	Cage clamp type
Interface relay for PLC, AC-solid state contact	RINT-18	6.2 mm		0.75 A / 250 V		Screw type
Interface relay for PLC, AC-solid state contact	RINT-28	6.2 mm		0.75 A / 250 V		Cage clamp type
AUTO-ON-OFF realy High power & signal contact	CHA1	11.5 mm		10 A / 250 V 300 mA / 30 V		
Power relay	CR16CX	13 mm		6 A / 250 V	6 A / 30 V	
Signal realy	CR11C	13 mm		1 A / 125 V	1 A / 30 V	
Control relay	CR33A	13 mm		3 A / 250 V	3 A / 30 V	
Stepping relay	CRS1C	13 mm		6 A / 250 V	6 A / 30 V	
Power relay	B103	17.5 mm		10 A / 250 V	6 A / 25 V	
Power relay, 2 channels	C203.01	17.5 mm		6 A / 250 V	6 A / 25 V	
Signal realy	C203.04	17.5 mm		5 A / 250 V	5 A / 30 V	
Signal realy	C301.04	17.5 mm		5 A / 250 V	5 A / 30 V	
Solid-state relay	KDW3-24	17.5 mm			3 A / 24 V	



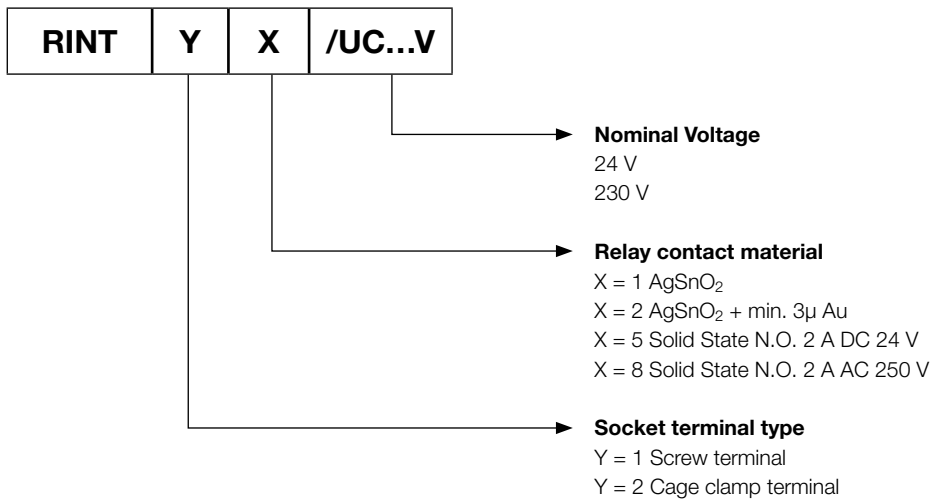
- ✓ Relay module up to 6A 250V, different contact material
- ✓ Solid state modules DC, AC up to 2A
- ✓ Coil UC = AC/DC, not polarised, integrated freewheeling circuit
- ✓ LED status display
- ✓ Screw terminals or spring cage terminals
- ✓ Optional coloured plug-in bridges for different connections
- ✓ Narrow mounting 6,2 mm

RINT RELAY CODIFICATION AND ACCESSORIES

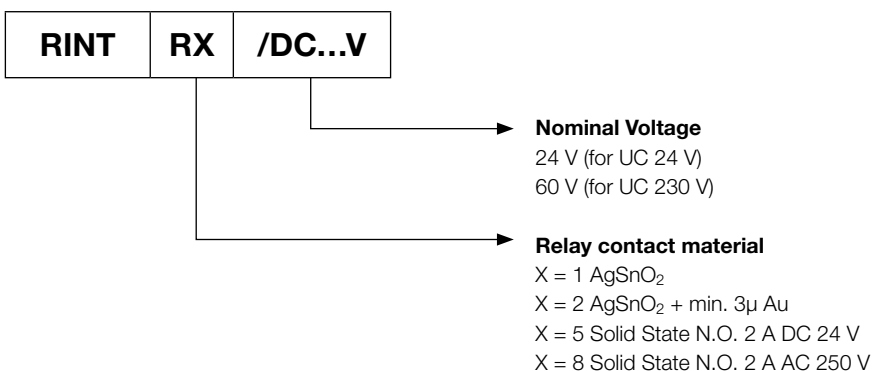
RINT INTERFACE RELAY CONSISTS OF TWO COMPONENTS.

- RELAY
- SOCKET

CODIFICATION FOR COMPLETE RELAY MODULE RELAY AND SOCKET 6,2 MM



RELAY CODIFICATION



RINT 11 ... 22 series 6.2 mm wide

Interface module with mechanical CO output contact

DIN Rail mounting according to DIN 43 880

Types: RINT-11, RINT-12, RINT-21, RINT-22, / ...V

Standard interface module, 1 change over contact

Type 1x: Screw terminal, Type 2x: Spring cage terminal

Control voltage UC 24 V and UC 230 V, 50/60 Hz

User friendly jumper system for in- and outputs, Yellow LED for status indication

Max. contact load **6 A, 250 V AC-1** **6 A, 25 V DC-1**

Contact Data

Type		micro disconnection
Material	Standard Code x1	AgSnO ₂
	Optional Code x2	AgSnO ₂ + 5µ gold plated
		AgSnO₂: + 5 µAu:
Max. operational current		6 A / 50 mA
Max. inrush current AC 15 op.		30 A / 50 mA
Max. switching voltage AC-1		250 V / 30 V
Max. AC load		1500 VA / —
Max. DC load 24 V/220 V		140 W/40 W / 24 V: 1.2 W
Recommended min. contact load		100 mA, 12 V / 1 mA, 0.1 V

Control input V_n =

	UC 24 V	UC 230 V
Operating voltage range @ 40 °C	20.5 ... 33 V	184 ... 257 V
Typical input current	11 / 8.5 mA	3 mA
Release voltage	< 4 V	< 60 V
Nominal power consumption	270 mW	700 mW

Insulation

Test voltage I / O	4 kVrms 1minute
Pollution degree	3
Over voltage category	III
Open contact	1000 Vrms dielectric strength 1 min
Max. working voltage	250 V
Standard	IEC 60 664

General Specifications

Ambient temperature: operation	-25 ... +60 °C, 230 V: ...+55 °C
storage	-40 ... 85 °C
Typical response time @ V _n	7 ms
Typical release time @ V _n	15 ms
Service life mech./elec.	≥ 10 ⁷ / ≥ 10 ⁵ operations
Cond. cross section screw terminal	solid/stranded wire 0.14 ... 2.5 / 1.5 mm ²
Cond. cross section spring cage	solid/stranded wire 0.2 ... 2.5 / 1.5 mm ²
Ingress protection	IP 20, plug-in module: IP57
Mounting position	any
Housing material	Polyamide PA

Standard types

UC 24, UC230, screw terminal:

UC 24, UC230, screw terminal, gold plated:

UC 24, UC230, spring cage terminal:

UC 24, UC230, spring cage terminal, gold plated:

RINT-11/UC...V

RINT-12/UC...V

RINT-21/UC...V

RINT-22/UC...V

"..." enter the voltage for full type designation

Accessories

Plug-in bridges 500 mm:

blue: **RINT-BR1-500B**

gray: **RINT-BR1-500G**

Plug-in bridges 6 mm:

blue: **RINT-BR2-6B/10**

gray: **RINT-BR2-6G/10**

red: **RINT-BR2-6R/10**

Label plate:

RINT-MA6-0/100 (100 pieces)

Replacement relay for RINT-11/21:

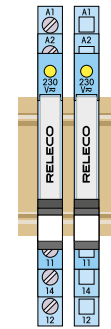
RINT-R1/DC (for UC24V)

RINT-R1/DC 60V (for UC230V)

Replacement relay for RINT-12/22:

RINT-R2/DC (for UC24V)

RINT-R2/DC 60V (for UC230V)



Connection diagram

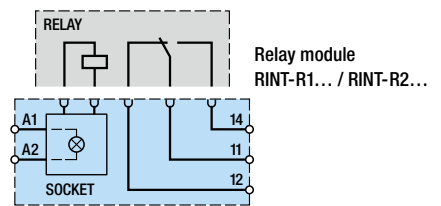


Fig.1 AC voltage endurance RINT 11, 21

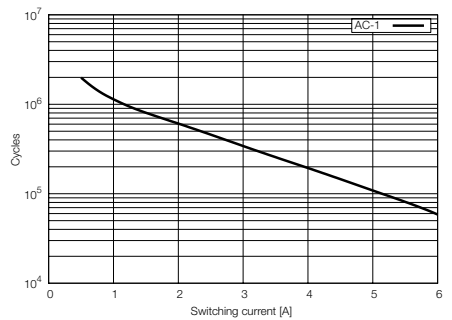
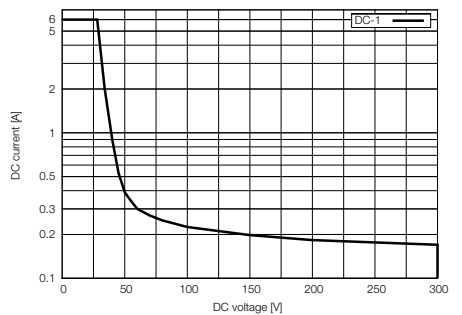
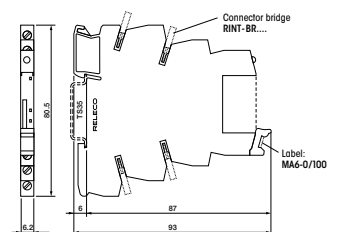


Fig. 2 DC load limit curve RINT 11, 21



Dimensions [mm]



Technical approvals, conformities



RINT 15 ... 25 series 6.2 mm wide

Interface module with solid state DC relay

DIN Rail mounting according to DIN 43 880



Types: RINT-15, RINT-25, /DC24V

Standard interface module, Solid state DC

Type 1x: Screw terminal, Type 2x: Spring cage terminal

DC 24 V control voltage, User friendly jumper system for in- and outputs

Yellow LED for status indication

Max. output load **2 A / 33 V**

Output data

Type	NO solid state DC, 2 wire floating
Polarity reversal & overvoltage	protected
Max. continuous current	2 A
Max. inrush current (10 ms)	15 A
Switching voltage	3 ... 33 V
Max. DC load 24 V	48 W
Max. voltage drop @ 2 A	200 mV

Control input $V_n =$

Operating voltage range	19 ... 29 V
Release voltage	< 9 V
Typical input current @ 24 V	8.5 mA
Nominal power consumption	210 mW
Polarity reversal	protected

Insulation

Test voltage I / O	2.5 kVrms 1 minute
Pollution degree	2
Over voltage category	III
Standard	IEC 60 664

General Specifications

Ambient temperature: operation	-25 ... +60 °C
storage	-25 ... 70 °C
Typical response time @ V_n	20 μ s
Typical release time @ V_n	500 μ s
Wire size, screw terminal	solid/stranded wire 0.14 ... 2.5 mm ²
Wire size, spring cage	solid/stranded wire 0.14 ... 2.5 mm ²
Ingress protection	IP 20, plug-in module: IP57
Mounting position	any
Housing material	Polyamide PA

Standard types

DC 24V, screw terminal:

RINT-15/DC24V

DC 24V, spring cage terminal:

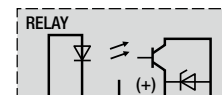
RINT-25/DC24V

Accessories

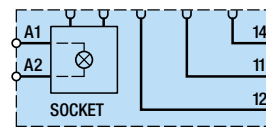
Plug-in bridges: 500 mm:	blue:	RINT-BR1-500B
	gray:	RINT-BR1-500G
Plug-in bridges: 6 mm:	blue:	RINT-BR2-6B/10
	gray:	RINT-BR2-6G/10
	red:	RINT-BR2-6R/10
Label:		RINT-MA6-0/100 (100 pieces)
Replacement relay:		RINT-R5/DC24V



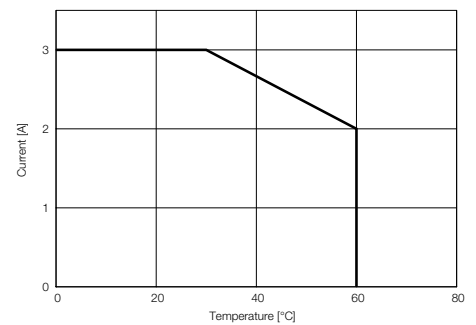
Connection diagram



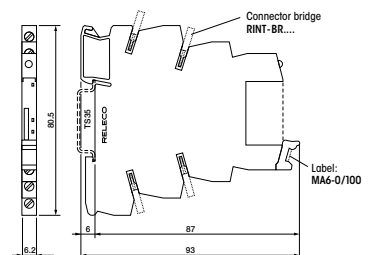
Solid-State module
RINT-R5/DC24V



Output derating curve



Dimensions [mm]



Technical approvals, conformities



RINT 18 ... 28 series 6.2 mm wide

Interface module with solid state AC triac

DIN Rail mounting according to DIN 43 880

Types: RINT-18, RINT-28, / DC24V

Standard interface module, Solid state AC (triac)
 Type 1x: Screw terminal, Type 2x: Spring cage terminal
 DC 24 V control voltage, User friendly jumper system for in- and outputs
 Yellow LED for status indication

Max. output load **0.75 A / 250 V**

Output data

Type NO solid state AC, 2 wire floating
 Switching AC voltage range 24 ... 253 V
 Max. voltage drop < 1 V
 Max. continuous current 0.75 A
 Max. inrush current (10 ms) 30 A
 Min. load current 10 mA
 I²t value 4.5 A²s
 Leakage current < 1 mA
 Protection RCV circuit

Control input V_n = DC 24 V

Operating voltage range 19 ... 29 V
 Release voltage < 6 V
 Typical input current @ 24 V 8 mA
 Nominal power consumption 200 mW
 Polarity reversal protected

Insulation

Test voltage I / O 2.5 kVrms 1minute
 Pollution degree 2
 Over voltage category III
 Standard IEC 60 664

General Specifications

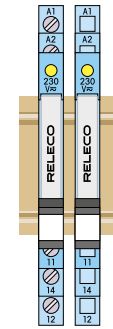
Ambient temperature: operation -25 ... +60 °C
 storage -25 ... 70 °C
 Typical response time @ V_n 10 ms
 Typical release time @ V_n 10 ms
 Wire size, screw terminal solid/stranded wire 0.14 ... 2.5 mm²
 Wire size, spring cage solid/stranded wire 0.14 ... 2.5 mm²
 Ingress protection IP 20
 Mounting position any
 Housing material Polyamide PA

Standard types

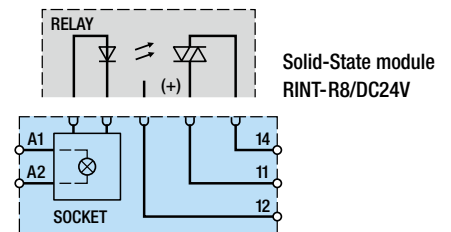
DC24V, screw terminal: RINT-18/DC24V
DC24V, spring cage terminal: RINT-28/DC24V

Accessories

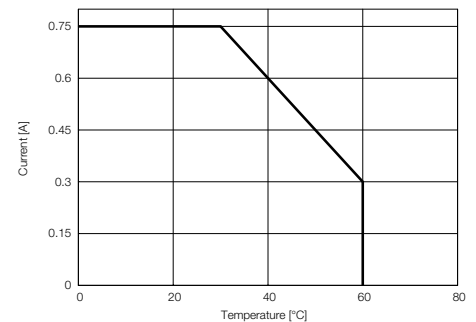
Plug-in bridges: 500 mm: blue: **RINT-BR1-500B**
 gray: **RINT-BR1-500G**
 Plug-in bridges: 6 mm: blue: **RINT-BR2-6B/10**
 gray: **RINT-BR2-6G/10**
 red: **RINT-BR2-6R/10**
 Label: **RINT-MA6-0/100** (100 pieces)
 Replacement relay: **RINT-R8/DC24V**



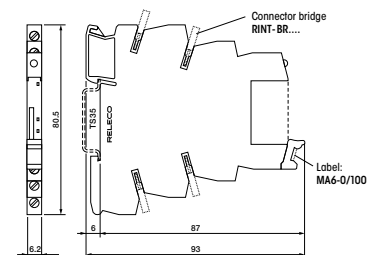
Connection diagram



Output derating curve



Dimensions [mm]



Technical approvals, conformities



CHA1

Auto-ON-OFF Interface Relay

DIN Rail mounting according to DIN 43 880

Type: CHA1/UC24V

Auto ON-OFF relay with override switch and check back signal contact, e.g. for PLC. It is suitable for either automatic control or function override for maintenance, emergency, installations etc.

1 change over power contact with 2500 VA switching capacity

1 normally closed signal contact 0.3 A, 30 V

UC 24 V control voltage, DC, AC 50 / 60 Hz

LED for status indication

Maximum contact load 2500 VA AC1, 250 W DC1
Recommended minimum contact load 10 mA / 12 V

Contact data	Power cont.	Signal cont.
Contact type	1CO, micro disconnection	1NC
Material	AgSnO ₂	Ag
Rated operational current	10 A	0.3 A
Max. inrush current (20 ms)	15 A	0.5 A
Max. switching voltage AC-1	250 V	30 V
Max. AC load	2500 VA AC-1, 500 VA AC-15	
Max. Motor load AC-3	0.44 kW	
Max. DC load DC-1	10 A 24 V, 0.12 A 220 V	10 W
Min. switching load	300 mW	

Control input V _n =	UC 24 V (AC or DC)
Operating voltage range	19 ... 26.5 V
Release voltage	< 3 V, typically 5 V
input current @ V _n	≤ 17 mA
Nominal power consumption	400 mW

Insulation	
Withstand voltage I / O	Pulse 4 kV (1.2/50μs)
Open contact	1000 Vrms dielectric strength

General Specifications

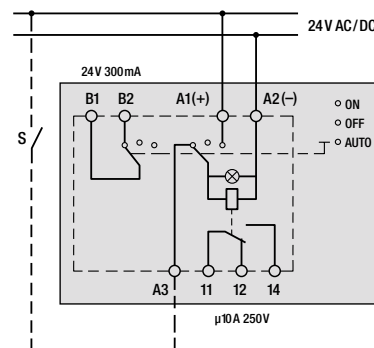
Ambient temperature: operation	-10 ... +50 °C
Typical response time @ V _{nom}	5 ... 10 ms
Typical release time @ V _{nom}	7 ... 12 ms
Mechanical life	≥ 10 ⁷ operations
Electrical life AC-1	≥ 10 ⁵ operations
Ingress protection degree	IP 20
Conductor cross section, solid wire size	1 x 6 mm ² / AWG10, 2 x 2.5 mm ² /AWG 12
Conductor cross section, stranded wire size	1 x 4 mm ² / AWG12, 2 x 1.5 mm ² /AWG 16
Max. Screw torque	0.5 Nm

Standard types

CHA1/UC24V



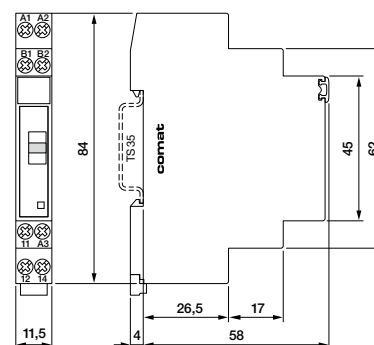
Connection diagram



Function table

Green ON-OFF-switch	Control input A3	Relay / LED	Check back contact
AUTO	1	1	1
	0	0	1
ON	-	1	0
OFF	-	0	0

Dimensions [mm]



Technical approvals, conformities



CR16CX

Power relay with 1-pole change over contact
DIN Rail mounting according to DIN 43 880

Type: CR16CX/...V R

Power relay
 1 change over contact
 control voltage DC 24 V and AC 230 V / 50 Hz
 LED status indicator
 Wash tight relay built in

Maximum contact load **6 A 250 V AC-1, 6 A 30 V DC-1**
Recommended minimum contact load **10 mA / 12 V**

Contacts

Type	Single contact micro disconnection
Material	AgNi
Rated operational current	6 A
Max. inrush current (20ms)	15 A
Max. switching voltage AC-1	250 V
Max. AC load AC-1	1500 VA
Max. DC load 24V/220V (Fig. 2)	180 W

Control input V_n =

	DC 24 V	AC 230
Operating voltage range	18 ... 27 V	190 ... 255 V
Input current @ V _n	12 ... 15 mA	12 ... 16 mA
Starting current	—	≤ 0.65 A / 0.1 ms
Release voltage	2.4 V	33 V
Nominal power consumption	330 mW	330 mW
Inductive turn-off voltage	damped, 57 Vp	suppressed

Insulation

Test voltage open contact	1 kVrms
Test voltage between contacts and coil	2.5 kVrms 1 minute

General Specifications

Ambient temperature storage / operation	-40 ... +85 °C / -25 ... +60 °C
Response time AC / DC	10 ms / 6 ms
Release time AC / DC	8 ... 20 ms / 10 ... 15 ms
Bounce time NO contact	2.5 ms
Operating frequency at nominal load	≤ 400 operations / h
Service life, mech./elec.	≥ 30 x 10 ⁶ / ≥ 1.5 x 10 ⁵ operations (Fig. 1)
Ingress protection degree	Housing: IP 40, terminals: IP 20
	contact: IP67
Max. Screw torque	0.4 Nm
Housing material	Lexan
Weight	50 g

Standard types

AC 230 V 50 Hz:	CR16CX/AC230V R
DC 24 V:	CR16CX/DC24V R

Accessories

Marking Strip:	
Large:	BS-13G
Small:	BS-13K



Connection diagram

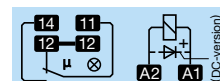


Fig.1 AC voltage endurance 250 V

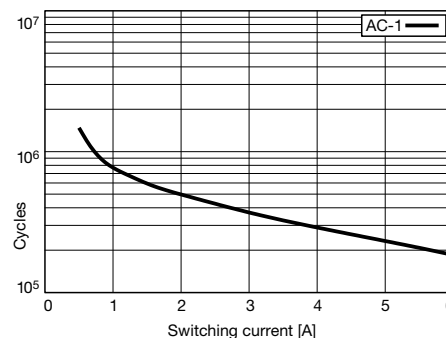
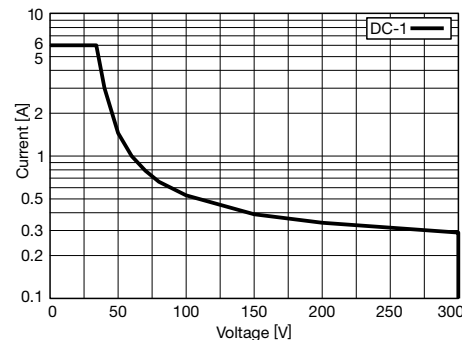
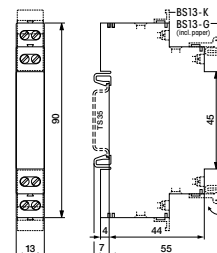


Fig. 2 DC load limit curve



Dimensions [mm]



Technical approvals, conformities



CR11C

Signal relay with 2-pole change over double contacts
DIN Rail mounting according to DIN 43 880



Type: CR11C/DC24V R

Signal relay
 2 change over double contacts
 LED status indicator
 Sealed relay built in

Maximum contact load 1 A, 125 V AC-1, 1 A 30 V DC-1
Minimum contact load 10 µA / 10 mV

Contacts

Type double contact micro disconnection
 Material Ag gold plated
 Max. operational current 1 A
 Max. switching voltage AC-1 125 V
 Max. AC load AC-1 0.5 A, 125 V, 62.5 VA
 Max. DC load (Fig. 2) 30 W

Remark: For preserving the gold plating do not exceed 30 V / 0.1 A resistive load.

Control input V_n = DC 24 V
 Operating voltage range 18 ... 30 V
 Input current @ V_n 10.5 ... 12 mA
 Release voltage 2.4 V
 Nominal power consumption 280 mW
 Inductive turn-off voltage damped, 45 Vp

Insulation

Test voltage open contact 0.75 kVrms 1 minute
 Test voltage between adjacent poles 0.5 kVrms, 1minute
 Test voltage between contacts and coil 1 kVrms 1 minute

General Specifications

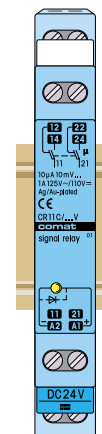
Ambient temperature storage/operation -40 ... +85 °C / -25 ... +60 °C
 Response time ≤ 3 ms
 Release time ≤ 4 ms
 Operating frequency at nominal load ≤ 400 operations / h
 Bounce time NO contact ≤ 1 ms
 Service live, mech./elec. ≥ 10⁸ / ≥ 10⁵ operations (Fig. 1)
 Ingress protection degree Housing: IP 40, terminals: IP 20
 contacts: IP67
 Housing material Lexan
 Max. Screw torque 0.4 Nm
 Weight 40 g

Standard types

DC 24 V **CR11C/DC24V R**

Accessories

Marking Strip:
 Large **BS-13G**
 Small **BS-13K**



Connection diagram

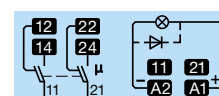


Fig.1 Contact endurance

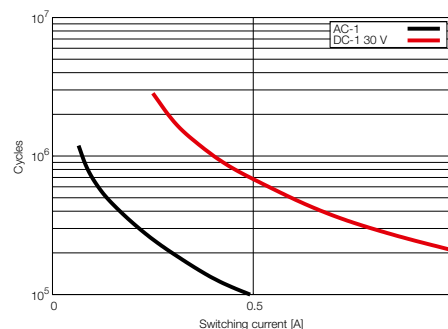
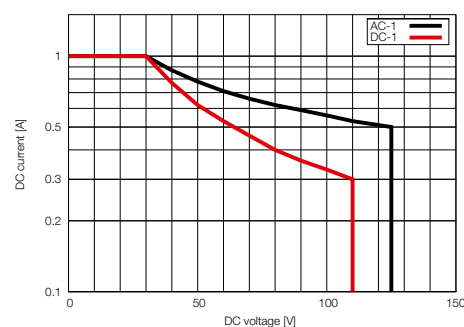
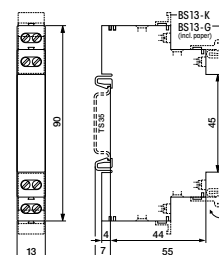


Fig. 2 Load limit curve



Dimensions [mm]



Technical approvals, conformities



EN 60947-4-1, EN 60947-5-1

CR33A

3 channels control relay with normally open double contacts
DIN Rail mounting according to DIN 43 880

Type: CR33A/DC24V R

3 channels control relay
 3 NO double contacts on common line
 LED status indicator for each channel
 Sealed relays built in

Maximum contact load **3 A, 250 V AC-1, 3 A 30 V DC-1**
Recommended minimum contact load **100 µA / 100 mV**

Contacts

Type	double contact micro disconnection
Material	Silver alloy gold plated
Max. operational current	3 A
Max. switching voltage AC-1	250 V
Max. AC load AC-1	750 VA
Max. DC load (Fig. 2) DC-1	150 V 0.24 A, 90 W

Remark: For preserving the gold plating do not exceed 30 V / 0.1 A resistive load.

Control input V_N

DC 24 V

Operating voltage range	18 ... 29 V
Input current per channel @ V _N	8 ... 10 mA
Release voltage	2.4 V
Nominal power consumption per channel	250 mW
Inductive turn-off voltage	damped, 30 Vp

Insulation

Test voltage open contact	0.75 kVrms 1 minute
Test voltage between contacts and coil	2 kVrms 1 minute

General Specifications

Ambient temperature storage/operation	-40 ... +85 °C / -25 ... +60 °C
Response time	≤ 6 ms
Release time	≤ 4 ms
Service life, mech./elec.	≥ 2 x 10 ⁷ / ≥ 10 ⁵ operations (Fig. 1)
Ingress protection degree	Housing: IP 40, terminals: IP 20 contacts: IP 67
Max. Screw torque	0.4 Nm
Housing material	Lexan
Weight	52 g

Standard types

DC 24 V: **CR33A/DC24V R**

Accessories

Marking Strip:	
Large	BS-13G
Small	BS-13K



Connection diagram

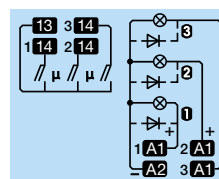


Fig.1 Contact endurance

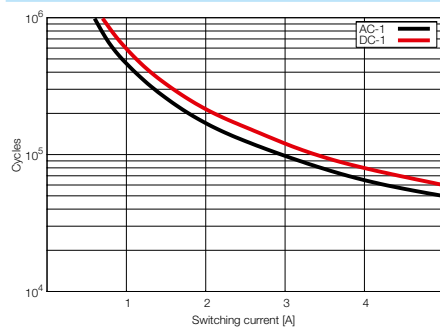
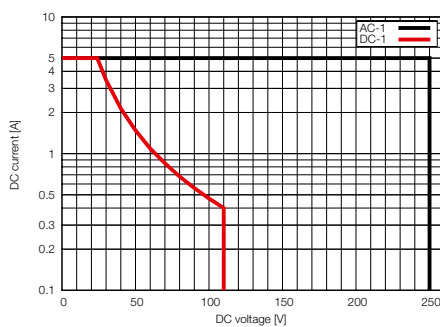
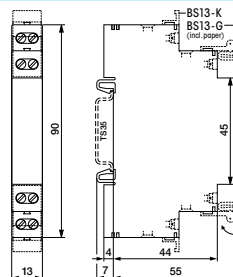


Fig. 2 Load limit curve



Dimensions [mm]



Technical approvals, conformities



EN 60947-4-1
 EN 60947-5-1

CRS1C

Stepping relay with 1-pole change over power contact DIN Rail mounting according to DIN 43 880

Type: CRS1C/...V R

Stepping relay (bistable, mech. latching)
1 change over contact with 0.5 mm gap

Maximum contact load 6 A / 250 V, 180 W DC-1
Recommended minimum contact load 0.1 A / 10 V

Contacts

Type	Single contact micro disconnection
Material	AgNi 10 + 0.2 µm Au
Rated operational current	
AC-1, AC-5a, AC-5b, AC-7a, AC-7b	6 A
Max. inrush current (20ms)	15 A
Max. switching voltage AC-1	250 V
Max. AC load (Fig. 1) AC-1	1500 VA
Max. DC load (Fig. 2) DC-1	180 W

Control input V_n =

	AC 230 V 50 Hz	DC 24 V
Operating voltage range	185 ... 255 V	19 ... 27 V
Max. pulse voltage	253 V * (t _{on} /t _p) ^{0.5}	26.4 V * (t _{on} /t _p) ^{0.5}
Op. voltage @100% duty cycle, 60 °C ambient temp., 6 A contact load	≤ 245 V	≤ 25.5 V
Nominal power consumption	1.4 VA	1 W
		With free wheeling diode

Coil Table

VAC	Ω ±10%	mA	VDC	Ω ±10%	mA
230	25	60 mA	24	575	42

Insulation

Test voltage open contact	1 kVrms 1 minute
Test voltage between contacts and coil	4 kVrms 1 minute

General Specifications

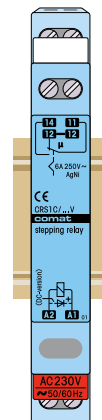
Ambient temperature storage/operation	-40 ... +85 °C / -25 ... +60 °C
Min. drive pulse width	50 ms
Mechanical life, DC drive / AC drive	≥ 10 ⁷ / ≥ 10 ⁵ operations
Electrical life 250 V, AC-1	≥ 10 ⁵ operations
Ingress Protection degree	Housing: IP 40, terminals: IP 20
Max. Screw torque	0.4 Nm
Housing material	Lexan
Weight	47 g

Standard types

AC 230 V, 50Hz/60Hz:	CRS1C/AC230V R
DC 24 V:	CRS1C/DC24V R

Accessories

Marking Strip:	
Large	BS-13G
Small	BS-13K



Connection diagram

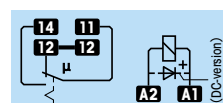


Fig.1 AC voltage endurance

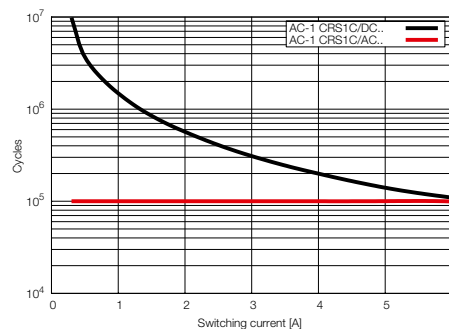
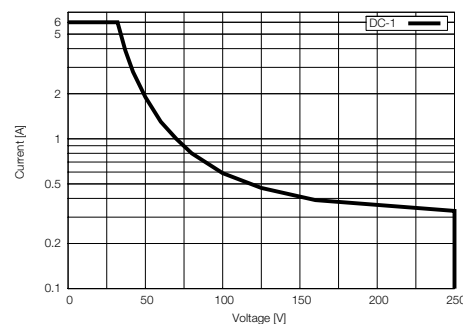
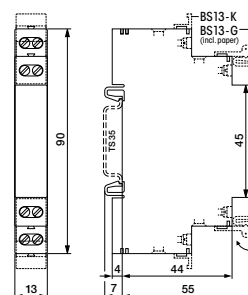


Fig. 2 DC load limit curve



Dimensions [mm]



Technical approvals, conformities

IEC 61810; EN 60947



B103

Power relay with 1-pole change over contact
DIN Rail mounting according to DIN 43 880

Type: B103/...V R

Power relay
 1 change over contact
 8 ... 240 V, UC / AC control voltage
 LED status indicator
 Wash tight relay built in
 Also suitable for panel mounting 2 x M4

Maximum contact load 10 A 250 V AC-1, 6 A 25 V DC-1
Recommended minimum contact load 10 mA / 12 V

Contacts

Type Single contact micro disconnection
 Material AgSnO2
 Rated operational current 10 A
 Max. inrush current (10ms) 16 A
 Max. switching voltage AC-1 250 V
 Max. AC load 2500 VA AC-1
 Max. DC load 24V/220V (Fig. 2) 150 W / 50 W

Control input V_n =

	DC 12 V	UC 24 V	UC 48 V	AC 110 - 127 V 50Hz/60Hz	AC 220 - 240 V 50Hz/60Hz
Operating voltage range [V]	7.5 ... 15	19 ... 29	38 ... 57	90 ... 150	190 ... 265
Input current @ V _{nom} [mA]	≤ 100	≤ 25	≤ 15	≤ 25 / 30	≤ 25 / 30
Release voltage [V]	≥ 2	≥ 3.5	≥ 6	≥ 12 / 10	≥ 20 / 18
Nom. power consumption [W]	≤ 0.9/1.2	≤ 0.5/0.6	≤ 0.7/0.8	≤ 0.8/1.2	≤ 0.8/1.2
Inductive turn-off voltage	None	None	None	None	None

Insulation

Test voltage open contact 1 kVrms
 Test voltage between contacts and coil 2 kVrms 1 minute

General Specifications

Ambient temperature storage/operation -40 ... +85 °C / -25 ... +60 °C
 Response time AC/DC 20 ms / 7 ms
 Release time 5 ... 12 ms
 Bounce time NO/NC contact typ. 0.5 ms / 3 ms
 Mechanical life ≥ 20 x 10⁶
 Conductor cross section Stranded wire 2.5 mm², 2 x 1.5 mm²
 Ingress protection degree Housing: IP 40, terminals: IP 20
 Max. Screw torque 0.4 Nm
 Housing material Lexan
 Weight 50 g

Standard types

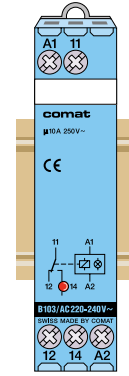
UC (AC / DC) 50/60Hz: 8-12, 24, 48
AC 50 / 60 Hz: 110-127, 220-240

B103/UC ...V R
B103/AC ...V R

"..." enter the voltage for full type designation

Accessories

Label plate: **BZS-DIN17.5**



Connection diagram

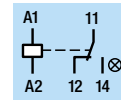


Fig.1 AC voltage endurance 250 V AC-1

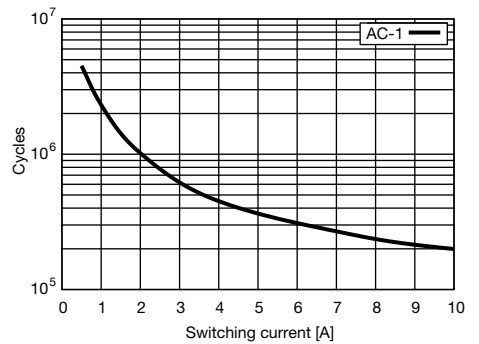
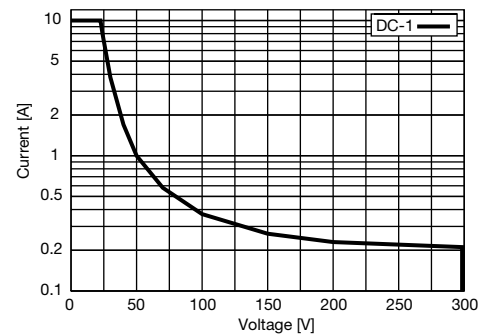
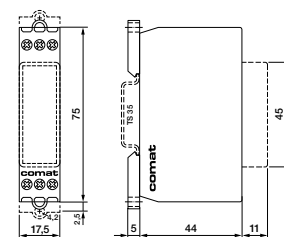


Fig. 2 DC load limit curve DC-1



Dimensions [mm]



Technical approvals, conformities



C203.01

2 channels power relay with change over single contacts DIN Rail mounting according to DIN 43 880

Type: C203.01/...V R

- 2 channels power relay
- 2 separate change over contacts
- 12 ... 230 V control inputs
- LED status indicator for each channel
- Wash tight relays built in
- Also suitable for panel mounting 2 x M4

Maximum contact load	6 A 250 V AC-1, 6 A 25 V DC-1
Recommended minimum contact load	100 mA / 12 V

Contacts

Type	Single contact micro disconnection
Material	AgNi
Rated operational current	6 A
Max. inrush current (20ms)	15 A
Max. switching voltage AC-1	250 V
Max. AC load (Fig.1)	1500 VA AC-1
Max. DC load 24 V/220 V (Fig.2)	150 W / 50 W

Control input per channel V_n =

	DC 12 V	UC 24 V	UC 48 V	AC 110 - 127 V 50Hz/60Hz	AC 220 - 240 V 50Hz/60Hz
Operating voltage range [V]	10 ... 15	20 ... 29	38 ... 57	90 ... 150	190 ... 265
Input current @ V _{nom} [mA]	≤ 40	≤ 25	≤ 11	≤ 12/15	≤ 12/15
Release voltage [V]	≥ 1.2	≥ 2.4	≥ 4.8	≥ 20	≥ 40
Nom. power consumption [W]	≤ 0.4	≤ 0.6	≤ 0.55	≤ 0.8 / 1	≤ 0.9 / 1.2
Inductive turn-off voltage	None	None	None	None	None

Insulation

Open contact	1 kVrms 1 minute
Between adjacent poles	2 kVrms 1 minute
Between contacts and coil	2 kVrms 1 minute

General Specifications

Ambient temperature storage/operation	-40 ... +85 °C / -25 ... +60 °C
Response time	2 – 15 ms
Release time	10 – 35 ms
Bounce time	≤ 3 ms
Mechanical life	20 x 10 ⁶ operations
Conductor cross section	Stranded wire 2.5 mm ² , 2 x 1.5 mm ²
Max. screw torque	0.4 Nm
Ingress protection degree	Housing: IP 40, terminals: IP 20
Housing material	Lexan
Weight	80 g

Standard types

AC 50 Hz / 60 Hz: 110 – 127, 220 – 240

UC (AC / DC): 24, 48

DC 12 V:

C203.01/AC...V R

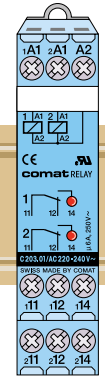
C203.01/UC ...V R

C203.01/DC12V R

"..." enter the voltage for full type designation

Accessories

Label plate: **BZS-DIN17.5**



Connection diagram

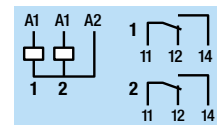


Fig. 1 AC voltage endurance 250 V

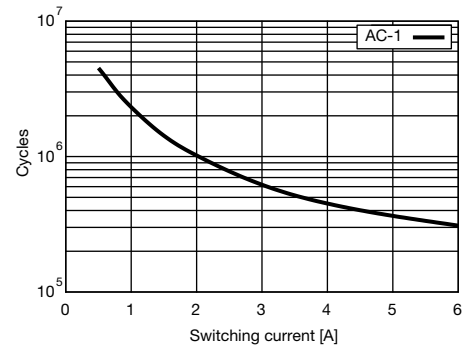
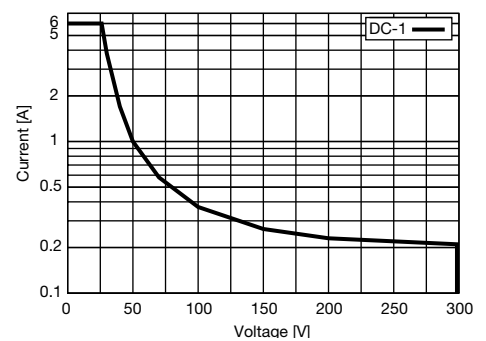
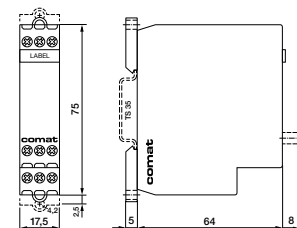


Fig. 2 DC load limit curve DC-1



Dimensions [mm]



Technical approvals, conformities



EN 60947-4-1, EN 60947-5-1

C203.04

2 channels control relay for medium and very low contact load with change over single contacts, DIN Rail mounting according to DIN 43 880

Type: C203.04/...V R

- 2 channels power relay
- 2 separate change over contacts
- 12 ... 48 V control inputs
- LED status indicator for each channel
- Sealed relays built in
- Also suitable for panel mounting 2 x M4

Maximum contact load 5 A 250 V AC-1, 5 A 30 V DC-1
Recommended minimum contact load 1 mA / 0.1 V

Contacts

Type	Single contact micro disconnection
Material	Gold flash over silver alloy
Rated operational current	5 A
Max. switching voltage AC-1	250 V
Max. switching voltage DC-1	125 V
Max. AC load (Fig.1) AC-1	1250 VA
Max. DC load 30 V / 125 V (Fig.2)	150 W / 25 W

Control input per channel V_n =

	DC 12-15 V	UC 24 V	UC 48 V
Operating voltage range [V]	11 ... 18	20 ... 29	38 ... 53
Input current @ V _{nom} [mA]	≤ 25	≤ 16	≤ 25
Release voltage [V]	≥ 2	≥ 3.5	≥ 6
Nom. power consumption [W]	≤ 0.35	≤ 0.4	≤ 1
Inductive turn-off voltage	None	None	None
Polarity reversal	protected	protected	protected

Insulation

Open contact	1 kVrms
Between adjacent poles	2 kVrms
Between contacts and coil	2 kVrms

General Specifications

Ambient temperature storage/operation	-40 ... +85 °C / -25 ... +60 °C
ON delay	≤ 6 ms
Release time	≤ 30 ms
Bounce time NO contact	≤ 3 ms
Mechanical life	≥ 50 x 10 ⁶ operations
Conductor cross section	Stranded wire 2.5 mm ² , 2 x 1.5 mm ²
Max. Screw torque	0.4 Nm
Ingress protection degree	Housing: IP 40, terminals: IP 20
Housing material	Lexan
Weight	80 g

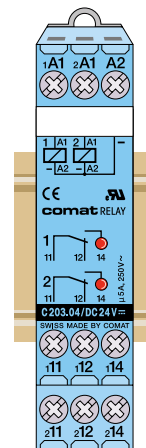
Standard types

DC: 12-15, 24, 48 **C203.04/DC ...V R**

"..." enter the voltage for full type designation

Accessories

Label plate: **BZS-DIN17.5**



Connection diagram

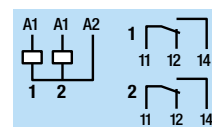


Fig.1 Contact endurance

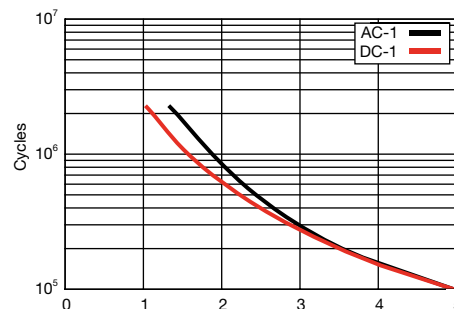
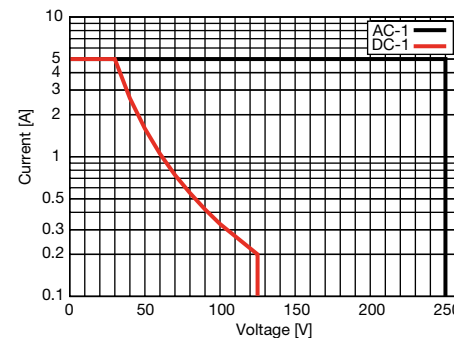
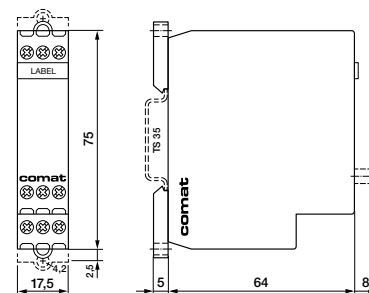


Fig. 2 Load limit curve



Dimensions [mm]



Technical approvals, conformities



EN 60947-4-1, EN 60947-5-1

C301.04

3 channels control relay for medium and very low contact load with normally open double contacts, DIN Rail mounting according to DIN 43 880



Type: C301.04/...V R

- 3 channels control relay
- 3 separate normally open double contacts of high reliability
- 12 ... 48 V control inputs
- LED status indicator for each channel
- Sealed relays built in
- Also suitable for panel mounting 2 x M4

Maximum contact load	5 A 250 V AC-1, 5 A 30 V DC-1
Recommended minimum contact load	1 mA / 0.1 V

Contacts

Type	Double contact micro disconnection
Material	Gold flash over silver alloy
Rated operational current	5 A
Max. switching voltage AC-1	250 V
Max. switching voltage DC-1	125 V
Max. AC load (Fig.1) AC-1	1250 VA
Max. DC load 30 V / 125 V (Fig.2)	150 W / 25 W

Control input per channel V_n =

	DC 12 -15 V	DC 24 V	DC 48 V
Operating voltage range [V]	11 ... 18	20 ... 29	38 ... 53
Input current @ V _{nom} [mA]	≤ 25	≤ 16	≤ 25
Release voltage [V]	≥ 2	≥ 3.5	≥ 6
Nom. power consumption [W]	≤ 0.35	≤ 0.4	≤ 1
Inductive turn-off voltage	None	None	None
Polarity reversal	protected	protected	protected

Insulation

Open contact	1 kVrms
Between adjacent poles	2 kVrms
Between contacts and coil	2 kVrms

General Specifications

Ambient temperature storage/operation	-40 ... +85 °C / -25 ... +60 °C
ON delay	≤ 6 ms
Release time	≤ 30 ms
Bounce time NO contact	≤ 3 ms
Mechanical life	≥ 50 x 10 ⁶ operations
Conductor cross section	Stranded wire 2.5 mm ² , 2 x 1.5 mm ²
Max. Screw torque	0.4 Nm
Ingress protection degree	Housing: IP 40, terminals: IP 20
Housing material	Lexan
Weight	80 g

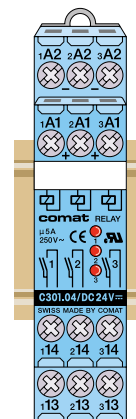
Standard types

DC, 12-15, 24, 48:	C301.04/DC ...V R
---------------------------	--------------------------

"..." enter the voltage for full type designation

Accessories

Label plate:	BZS-DIN17.5
--------------	--------------------



Connection diagram

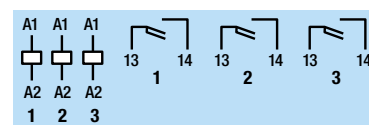


Fig.1 Contact endurance

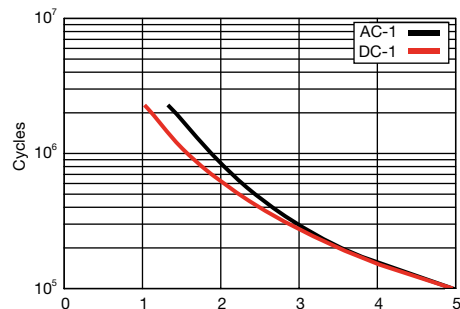
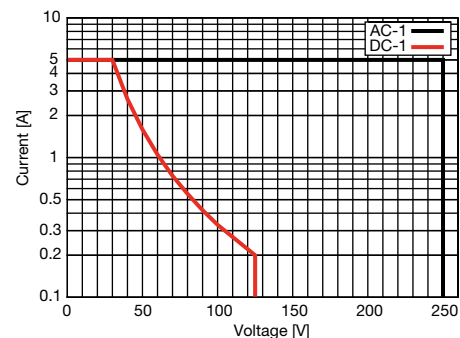
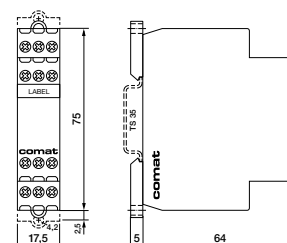


Fig. 2 Load limit curve



Dimensions [mm]



Technical approvals, conformities



KDW 3-24

Solid state switching over interface module with **two output channels** and **galvanically separated control input** with wide voltage range
DIN Rail mounting according to DIN 43 880

Type: KDW 3-24/UC24-240V R

24 V solid state switching over relay
 Two high side switches for 24 V/3 A
 all overload and short circuit protected
 suitable for all kind of loads, such as lamps, DC-motors, valves, etc.
 Control input for UC 24 ... 240 V (AC/DC)
 LED status indicator

Maximum load **3 A / 32 V**

Output data for each channel

Type: Power MOS FET	High side switch
Max. switching current	3 A
Max. continuous current	3 A (5 A) ¹⁾
Max. inrush current, 1 sec ²⁾	20 A
Switching voltage range	9 ... 32 V
Max. Load	100 W
Thermal overload protection ²⁾	self restoring
Over current limiting ²⁾	20 ... 30 A
Clamp voltage	41 ... 52 V
Max. inductive switch-off energy ²⁾	0.27 ... 340 Ws (see fig. 1)
ON resistance @ 25 °C	≤ 30 mΩ
Leakage current	≤ 50 μA

¹⁾ Repetitive operation: When the ratio $t_{\text{pulse}} / t_{\text{cycle}}$ is a low value then the current can be increased up to 5 A @ $T_A \leq 50$ °C. See fig. 2.

²⁾ Not for continuous repetitive operation

Control input $V_N =$ **UC 24-240 V (AC / DC)**

Operating voltage range	18 ... 255 V
Release voltage / current	≤ 8 V / ≤ 1 mA
Input current	2 mA – 8 mA
Max. power consumption	800 mW
Surge immunity EN 61000-4-5	2 kV

Insulation

Between input and outputs **2 kVrms 1 minute**

General Specifications

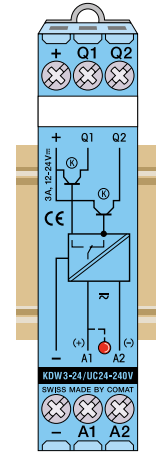
Ambient temperature storage/operation	-40 ... +85 °C / -25 ... +60 °C
ON delay	≤ 3 ms
Release time	≤ 4 ms
Max. Switching frequency	3600 ops/minute
Conductor cross section	Stranded wire 2.5 mm ² , 2 x 1.5 mm ²
Max. Screw torque	0.4 Nm
Ingress protection degree	Housing: IP 40, terminals: IP 20
Housing material	Lexan
Weight	30 g

Standard types

UC 50/60Hz (AC/DC) **KDW3-24 / UC24-240V R**

Accessories

Label plate: **BZS-DIN17.5**



Connection diagram

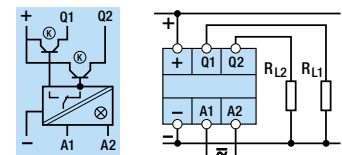


Fig.1 Load inductance vs. Loadcurrent

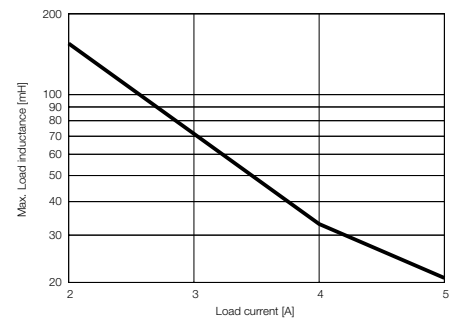
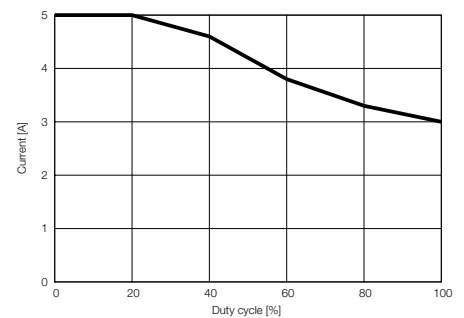
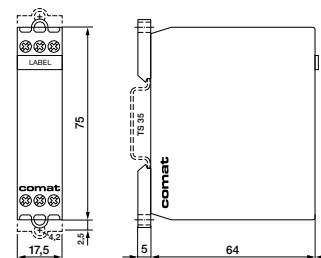


Fig. 2 Output current vs. duty cycle



Dimensions [mm]



Technical approvals, conformities



Suppressor module for relays with long power supply conductors DIN Rail mounting according to DIN 43 880

Type: CEM01/UC24-240V

The CEM is a suppressor module which is developed to counteract parasitic capacities or oscillating circuits in relay installations with long power supply conductors up to 500 meters. The implemented trigger element switches of the relay when a defined current value is exceeded. After de-energizing, the power consumption of the trigger element is reduced to a minimum.

Maximum compensated conductor length 500 m

Power supply

Nominal voltage AC / DC 24 ... 240 V
 Operation voltage range 19 ... 250 V
 AC Frequency 15 ... 63 Hz
 Power consumption

Compensation

Max. parasitic capacity 60 nF
 Max. conductor length 500 m

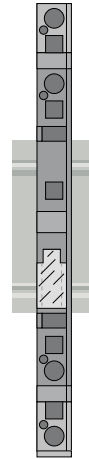
General specifications

Ambient temperature storage /operation -40 ... +85 °C / -40 ... +60 °C
 Connection terminals Cage clamp®
 Wire cross section 0.08 ... 2.5 mm² / AWG 28 ... 14
 Skinning length 5...6 mm / 0.22 in
 Ingress protection degree IP20
 Housing material PA 6.6
 Weight 14.5 g

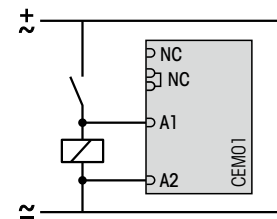
Standard types

AC/DC 24 - 240 V, 15 ... 63 Hz

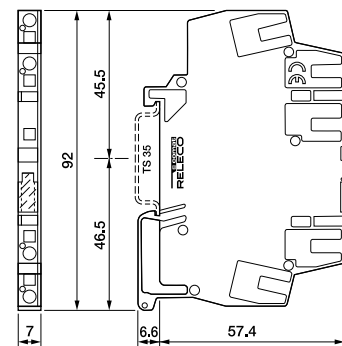
CEM01/UC24-240V



Connection diagram



Dimensions [mm]

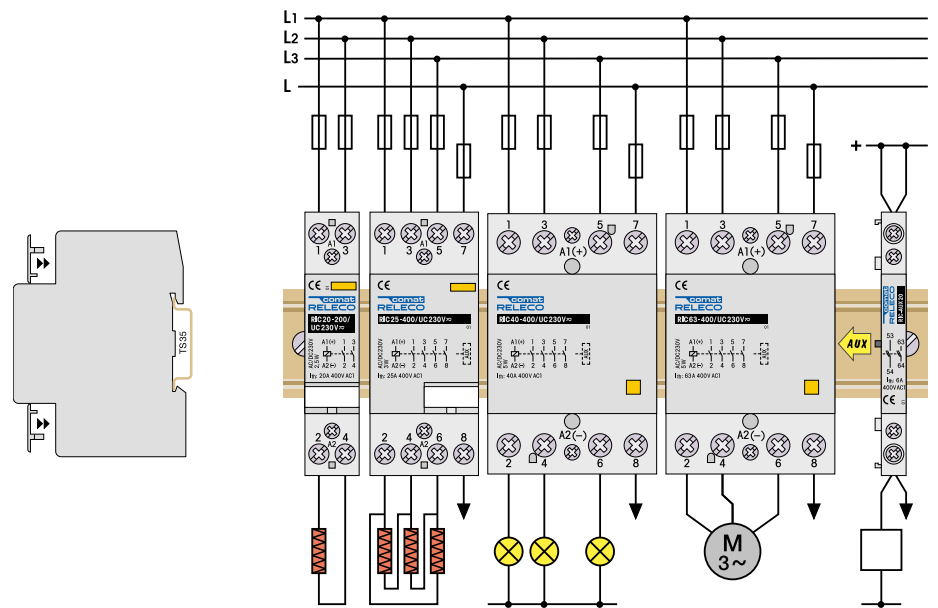


Technical approvals, conformities



1.2.2 Power Relays

Installation Contactor



- Different versions NO; NC; NC + NO
- AC/DC Coil **Hum free**
- No EMC (free wheeling circuit included)
- Robust and compact
- Wide Range of application
- Mounting according DIN/EN 43880 on DIN Rail TS 35
- Sealing cover optional

RIC20

20 A, AC/DC control voltage, silent operation
DIN rail mounting according to DIN 43 880



Type: RIC20-xxx/ ...V

Hum-free installation contactor, 2 contacts, 2 NO, 1 NO-1 NC, 2 NC types available

Rated operational power 4 kW / 230 V AC-1, 0.5 A / 220 V DC-1
Recommended minimum contact load 10 mA / 24 V

Contacts

Material	AgNi
Rated operational current	20 A
Max. inrush current (100ms)	50 A
Max. switching voltage	400 V
Max. AC load AC-1, AC-7a	4 kW / 230 V
AC-3	1.3 kW / 230 V (NO contact only)
Max. DC load 24 V / 220 V DC-1 (Fig. 1)	480 W / 130 V

Control input V_n =

	UC 24 V	UC 36 V	UC 230 V
Operating voltage range [V]	20.4 ... 26.4	30.6 ... 39.6	195 ... 253
Typ. pick up voltage [V]	17	25	160
Typ. release voltage [V]	7	11	70
Power consumption [W]	≤ 2.5	≤ 2.5	≤ 2.5
Inductive turn-off voltage	None	None	None
Surge immunity EN 6100-4-5	2 kV	2 kV	2 kV

Insulation

Rated insulation voltage	230 V
Rated impulse withstand voltage	4 kV
Min. clearance of open contact	3.6 mm

General Specifications

Ambient temperature storage	-30 ... 80 °C
operation, Spacer after 2 contactors side by side	-5 ... 55 °C
operation, Spacer after 3 contactors side by side	-5 ... 40 °C
Pick-up time	15 ... 45 ms
Release time	20 ... 50 ms
Mechanical life	≥ 3 x 10 ⁶ operations
AC voltage endurance at rated load AC-3, AC-7b	≥ 3 x 10 ⁵ operations
DC voltage endurance at rated load DC-1	10 ⁵ operations
Operating frequency at rated load DC-1	≤ 300 operations / h
Operating frequency at rated load AC-1	≤ 600 operations / h
Conductor cross section coil /contacts	Stranded wire 2.5 mm ² / 6 mm ²
Max. Screw torque coil /contacts	0.6 Nm / 1.2 Nm
Ingress protection degree	IP 20
Weight	140 g

Standard types

UC (AC / DC) 50 / 60 Hz, 24, 36, 230

2NO	RIC20-200/UC ...V
1NO + 1NC	RIC20-110/UC ...V
2NC	RIC20-020/UC ...V

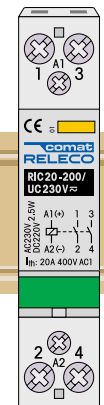
"..." enter the voltage for full type designation

Accessories

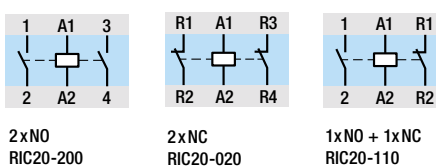
Sealing cover:	RIC-SEAL 20
Spacer:	RIC-DIST

Samples of lamp loads

	Number of lamps
Incandescent lamps 230 V / 100 W	20
Fluorescent lamps not corrected 230 V / 36 W	17
Fluorescent lamps electronic ballast units 36 W	15



Connection diagram



Coil circuit

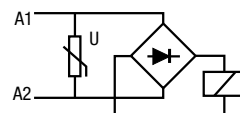
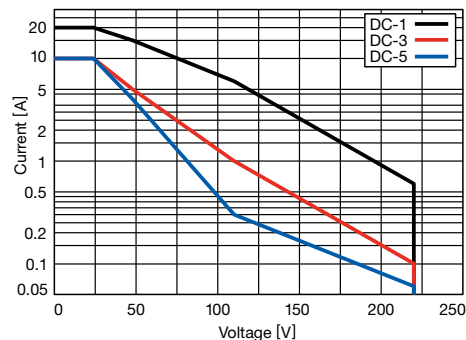
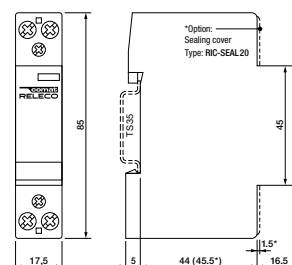


Fig. 1 DC load limit curve DC1



Dimensions [mm]



Technical approvals, conformities

CE
 IEC/EN 60947-4-1, VDE 0660
 IEC/EN 60947-5-1
 IEC/EN 61095, VDE 0637

Mounting information

If multiple contactors are mounted side by side, spacers (RIC DIST) have to be inserted for the purpose of heat dissipation.

Example: Ambient temperature up to 40°C: 1 spacer after 3 RIC // 40...55°C: 1 spacer after 2 RIC.

RIC25 (Railway)

25 A, AC/DC control voltage, silent operation
DIN Rail mounting according to DIN 43 880



Type: RIC25-xxx/ ...V

Hum-free installation contactor, 4 contacts, 4 NO, 4 NC, 2 NO-2 NC types available

Rated operational power AC-1	Single phase: 5.4 kW/230 V, 0.5 A/220 V DC-1 3 phase 230 V: 9 kW 3 phase 400 V: 16 kW
Recommended minimum contact load	10 mA / 24 V

Contacts

Material	AgNi
Rated operational current	25 A
Max. inrush current (100ms)	50 A
Max. switching voltage	400 V
Max. AC load 3 phase	AC-1, AC-7a 9 kW / 230 V, 16 kW / 400 V
	AC-3 2.2 kW / 230 V, 4 kW / 400 V
Max. DC load 24V/220V DC-1 (Fig. 1)	600 W / 130 W

Control input V_n =

	UC 24 V	UC 36 V	UC 230 V
Operating voltage range [V]	20.4 ... 26.4	30.6 ... 39.6	195 ... 253
Typ. pic up voltage [V]	17	25	160
Typ. release voltage [V]	7	11	70
Power consumption [W]	≤ 3	≤ 3	≤ 3
Inductive turn-off voltage	None	None	None
Surge immunity EN 6100-4-5	2 kV	2 kV	2 kV

Insulation

Rated insulation voltage	440 V
Rated impulse withstand voltage	4 kV
Min. clearance of open contact	3.6 mm

General Specifications

Ambient temperature storage	-30 ... 80 °C
operation, Spacer after 2 contactors side by side	-5 ... 55 °C
operation, Spacer after 3 contactors side by side	-5 ... 40 °C
Pick-up time	15 ... 45 ms
Release time	20 ... 70 ms
Mechanical life	≥ 3 x 10 ⁶ operations
AC voltage endurance at rated load AC-3, AC-7b	≥ 5 x 10 ⁵ operations
DC voltage endurance at rated load DC-1	10 ⁵ operations
Operating frequency at rated load DC-1	≤ 300 operations / h
Operating frequency at rated load AC-1, AC-3	≤ 600 operations / h
Conductor cross section coil / contacts terminals	Stranded wire 2.5 mm ² / 6 mm ²
Max. Screw torque coil / contacts	0.6 Nm / 1.2 Nm
Ingress protection degree	IP 20
Weight	270 g

Standard types

UC (AC / DC) 50 / 60 Hz, 24, 36, 230

4NO	RIC25-400/UC ...V
2NO + 2NC	RIC25-220/UC ...V
4NC	RIC25-040/UC ...V

"..." enter the voltage for full type designation

Accessories

Auxiliary contact bloc:	RIC-AUX..
Sealing cover:	RIC-SEAL 25
Spacer:	RIC-DIST

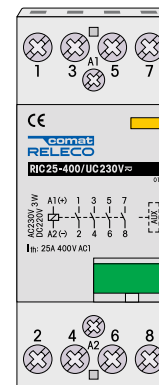
Samples of lamp loads

	Number of lamps
Incandescent lamps 230 V/ 100 W	20
Fluorescent lamps not corrected 230 V/ 36 W	20
Fluorescent lamps electronic ballast units 36 W	20

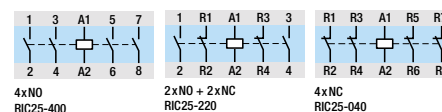
Mounting information

If multiple contactors are mounted side by side, spacers (RIC DIST) have to be inserted for the purpose of heat dissipation.

Example: Ambient temperature up to 40°C: 1 spacer after 3 RIC // 40...55°C: 1 spacer after 2 RIC.



Connection diagram



Coil circuit

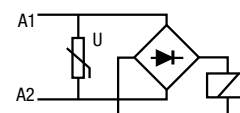
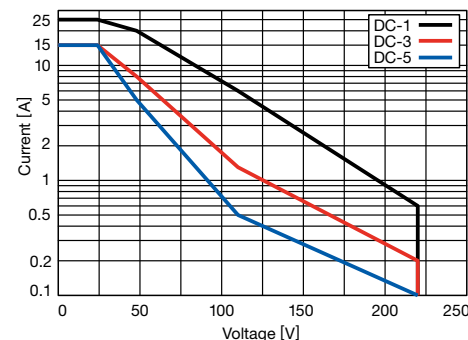
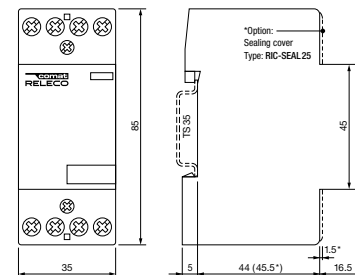


Fig. 1 DC load limit curve DC-1



Dimensions [mm]



Technical approvals, conformities

CE **RoHS**
 IEC/EN 60947-4-1
 IEC/EN 60947-5-1
 IEC/EN 61095

RIC40

40 A, AC/DC control voltage, silent operation
DIN rail mounting according to DIN 43 880



Type: RIC 40-xxx/...V

Hum-free installation contactor, 4 contacts, 4 NO, 2 NO-2 NC, 4 NC types available

Rated operational power AC-1	Single phase: 8.7 kW/230 V, 0.5 A / 220 V DC-1
	3 phase 230 V: 16 kW
	3 phase 400 V: 26 kW
Recommended minimum contact load	10 mA / 24 V

Contacts

Material	AgSnO ₂
Rated operational current	40 A
Max. inrush current (100ms)	150 A
Max. switching voltage	400 V
Max. AC load 3 phase AC-1, AC-7a	16 kW / 230 V, 26 kW / 400 V
AC-3	3.7 kW / 230 V, 11 kW / 400 V
Max. DC load 24V/220V DC-1(Fig. 1)	960 W / 260 V

Control input V_N = AC 50 / 60 Hz / DC

	UC 24 V	UC 230 V
Operating voltage range [V]	20.4 ... 26.4	195 ... 253
Typ. pic up voltage [V]	17	160
Typ. release voltage [V]	7	70
Power consumption [W]	≤ 5	≤ 5
Inductive turn-off voltage	None	None
Surge immunity EN 6100-4-5	2 kV	2 kV

Insulation

Rated insulation voltage	440 V
Rated impulse withstand voltage	4 kV
Min. clearance of open contact	3.6 mm

General Specifications

Ambient temperature storage	-30 ... 80 °C
operation, Spacer after 2 contactors side by side	-5 ... 55 °C
operation, Spacer after 3 contactors side by side	-5 ... 40 °C
Pick-up time	15 ... 45 ms
Release time	20 ... 70 ms
Mechanical life	≥ 3 x 10 ⁶ operations
AC voltage endurance at rated load AC-3, AC-7b	≥ 1.5 x 10 ⁵ operations
DC voltage endurance at rated load DC-1	10 ⁵ operations
Operating frequency at rated load DC-1	≤ 300 operations / h
Operating frequency at rated load AC-1, AC-3	≤ 600 operations / h
Conductor cross section coil /contacts terminals	Stranded wire 2.5 mm ² / 16 mm ²
Max. Screw torque coil /contacts	0.6 Nm / 2 Nm
Ingress protection degree	IP 20
Weight	420 g

Standard types

UC (AC / DC) 50 / 60 Hz, 24, 230	4NO	RIC40-400/UC ...V
	2NO + 2NC	RIC40-220/UC ...V
	4NC	RIC40-040/UC ...V

"..." enter the voltage for full type designation

Accessories

Auxiliary contact bloc:	RIC-AUX..
Sealing cover:	RIC-SEAL 40-63
Spacer:	RIC-DIST

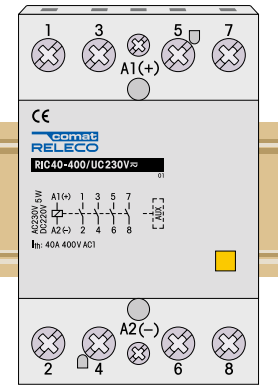
Samples of lamp loads

	Number of lamps
Incandescent lamps 230 V / 100 W	40
Fluorescent lamps not corrected 230 V / 36 W	65
Fluorescent lamps electronic ballast units 36 W	52

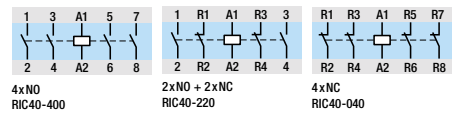
Mounting information

If multiple contactors are mounted side by side, spacers (RIC DIST) have to be inserted for the purpose of heat dissipation.

Example: Ambient temperature up to 40°C: 1 spacer after 3 RIC // 40...55°C: 1 spacer after 2 RIC.



Connection diagram



Coil circuit

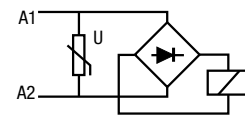
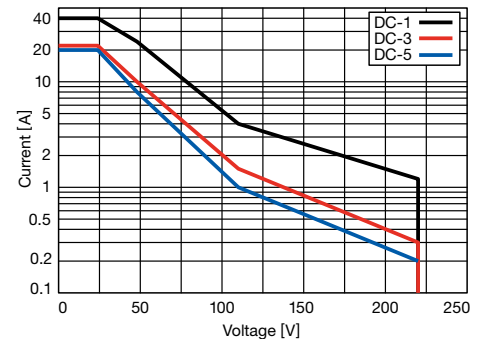
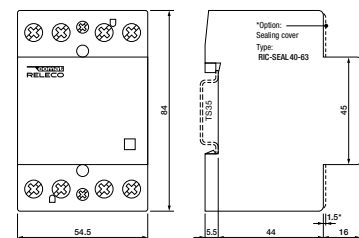


Fig. 1 DC load limit curve DC1



Dimensions [mm]



Technical approvals, conformities

CE

IEC/EN 60947-4-1
 IEC/EN 60947-5-1
 IEC/EN 61095

RIC63

63 A, AC/DC control voltage, silent operation

DIN Rail mounting according to DIN 43 880

Type: RIC 63-xxx/...V

Hum-free installation contactor, 4 contacts, 4 NO, 2 NO-2 NC types available

Rated operational power AC-1 **Single phase: 13.3 kW/230 V, 1.2 A/220VDC-1**
3 phase 230 V: 24 kW
3 phase 400 V: 40 kW

Recommended minimum contact load **10 mA / 24 V**

Contacts

Material	AgSnO ₂
Rated operational current	63 A
Max. inrush current (100ms)	150 A
Max. switching voltage	400 V
Max. AC load 3 phase AC-1, AC-7a	24 kW / 230 V, 40 kW / 400 V
AC-3	5 kW / 230 V, 15 kW / 400 V
Max. DC load 24 V / 220 V DC-1(Fig. 1)	1500 W / 260 W

Control input V_N = AC 50 / 60 Hz / DC

	UC 24 V	UC 230 V
Operating voltage range [V]	20.4 ... 26.4	195 ... 253
Typ. pick up voltage [V]	17	160
Typ. release voltage [V]	7	70
Power consumption [W]	≤ 5	≤ 5
Inductive turn-off voltage	None	None
Surge immunity EN 6100-4-5	2 kV	2 kV

Insulation

Rated insulation voltage	440 V
Rated impulse withstand voltage	4 kV
Min. clearance of open contact	3.6 mm

General Specifications

Ambient temperature storage	-30 ... 80 °C
operation, Spacer after 2 contactors side by side	-5 ... 55 °C
operation, Spacer after 3 contactors side by side	-5 ... 40 °C
Pick-up time	15 ... 45 ms
Release time	20 ... 70 ms
Mechanical life	≥ 3 x 10 ⁶ operations
AC voltage endurance at rated load AC-3, AC-7b	≥ 1.5 x 10 ⁵ operations
DC voltage endurance at rated load DC-1	10 ⁵ operations
Operating frequency at rated load DC-1	≤ 300 operations / h
Operating frequency at rated load AC-1, AC-3	≤ 600 operations / h
Conductor cross section coil /contacts terminals	Stranded wire 2.5 mm ² / 16 mm ²
Max. Screw torque coil /contacts	0.6 Nm / 2 Nm
Ingress protection degree	IP 20
Weight	420 g

Standard types

UC (AC / DC) 50 / 60 Hz, 24, 230	4NO	RIC63-400/UC ...V
"..." enter the voltage for full type designation	2NO + 2NC	RIC63-220/UC ...V

Accessories

Auxiliary contact bloc:	RIC-AUX..
Sealing cover:	RIC-SEAL 40-63
Spacer:	RIC-DIST

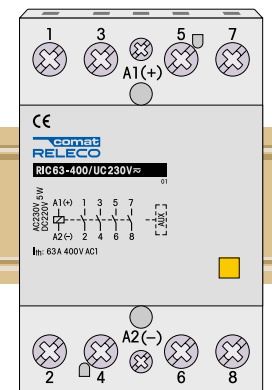
Samples of lamp loads

	Number of lamps
Incandescent lamps 230 V / 100 W	50
Fluorescent lamps not corrected 230 V / 36 W	95
Fluorescent lamps electronic ballast units 36 W	75

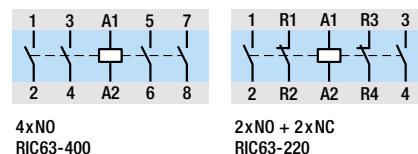
Mounting information

If multiple contactors are mounted side by side, spacers (RIC DIST) have to be inserted for the purpose of heat dissipation.

Example: Ambient temperature up to 40°C: 1 spacer after 3 RIC // 40...55°C: 1 spacer after 2 RIC.



Connection diagram



Coil circuit

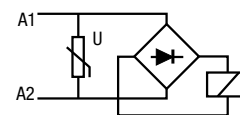
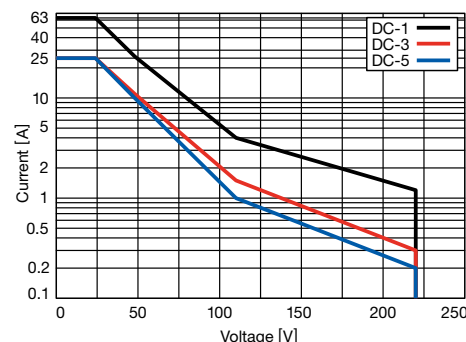
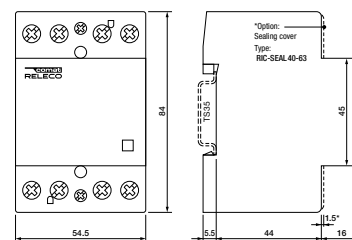


Fig. 1 DC load limit curve DC-1



Dimensions [mm]



Technical approvals, conformities

IEC/EN 60947-4-1
 IEC/EN 60947-5-1
 IEC/EN 61095

RIC-AUX

6 A auxiliary contact bloc with 2 double contacts, 3 different combinations of NO / NC contacts



Type: RIC AUXxx

2 double contacts, 2 NO, 1 NC-1 NO, 2 NC types available

Maximum contact load AC-15 6 A / 230 V, 4 A / 400 V
Recommended minimum contact load 10 mA / 24 V

Contacts

Material AgNi
Rated operational current AC-15 6 A / 230 V, 4 A / 400 V
Max. switching voltage with RIC 20 400 V

Insulation

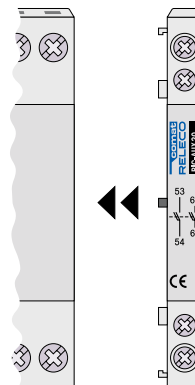
Rated insulation voltage on RIC 20 / 25 440 V
on RIC 40 / 63 500 V
Rated impulse withstand voltage 4 kV

Specifications

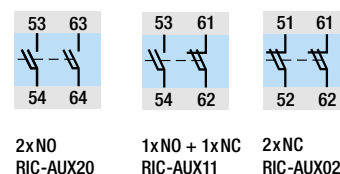
Ambient temperature storage / operation -30 ... 80 °C / -5 ... 55 °C
Operating frequency at rated load ≤ 600 operations / h
Conductor cross section Stranded wire 2.5 mm²
Max. Screw torque 0.8 Nm
Ingress protection degree IP 20
Weight 50 g

Standard types

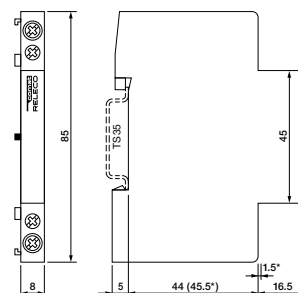
2NO	RIC-AUX20
1NO + 1NC	RIC-AUX11
2NC	RIC-AUX02



Connection diagram



Dimensions [mm]



Technical approvals, conformities

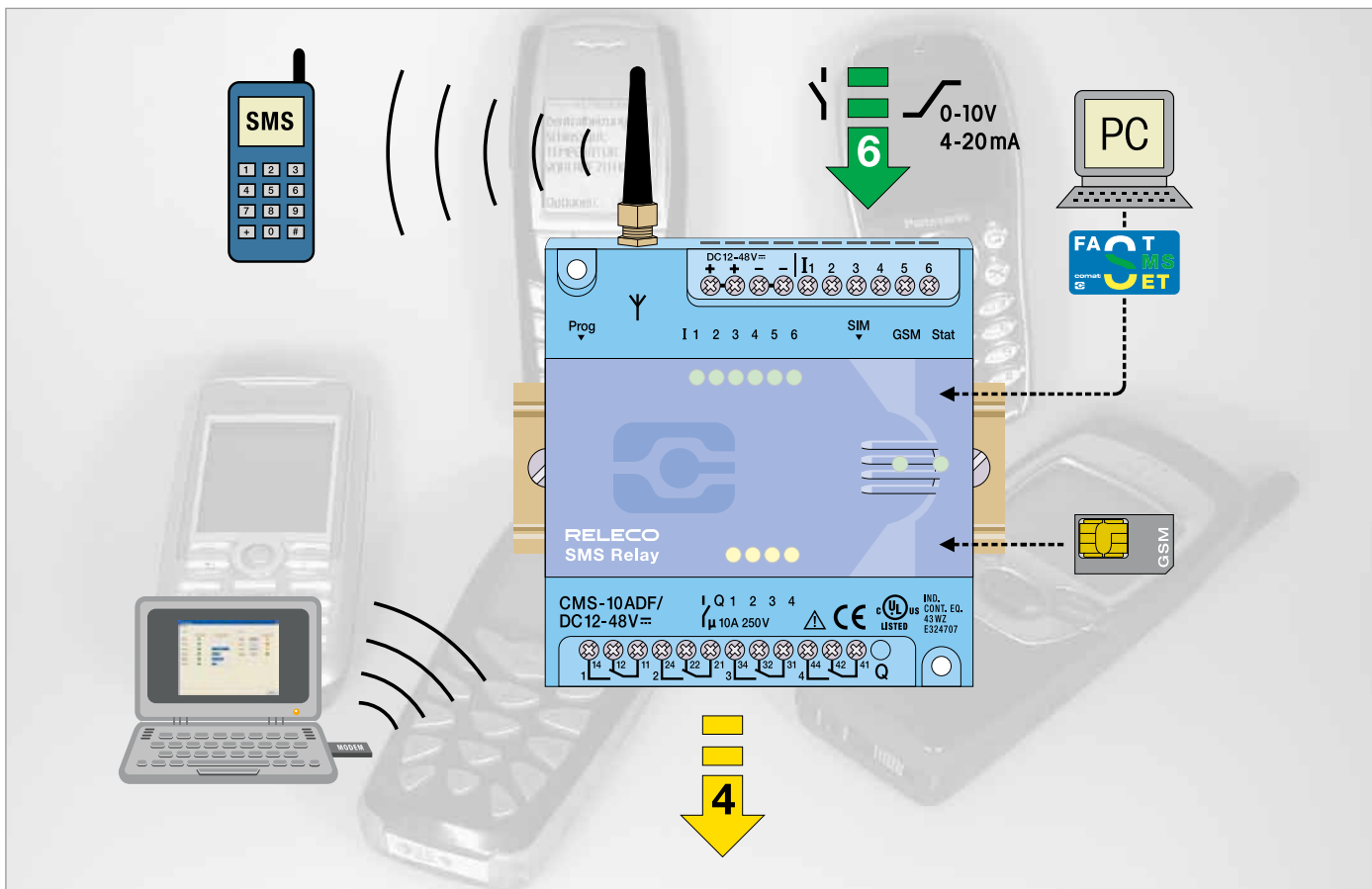
CE **RoHS**
IEC/EN 60947-4-1
IEC/EN 60947-5-1
IEC/EN 61095

NEW
With additional functions

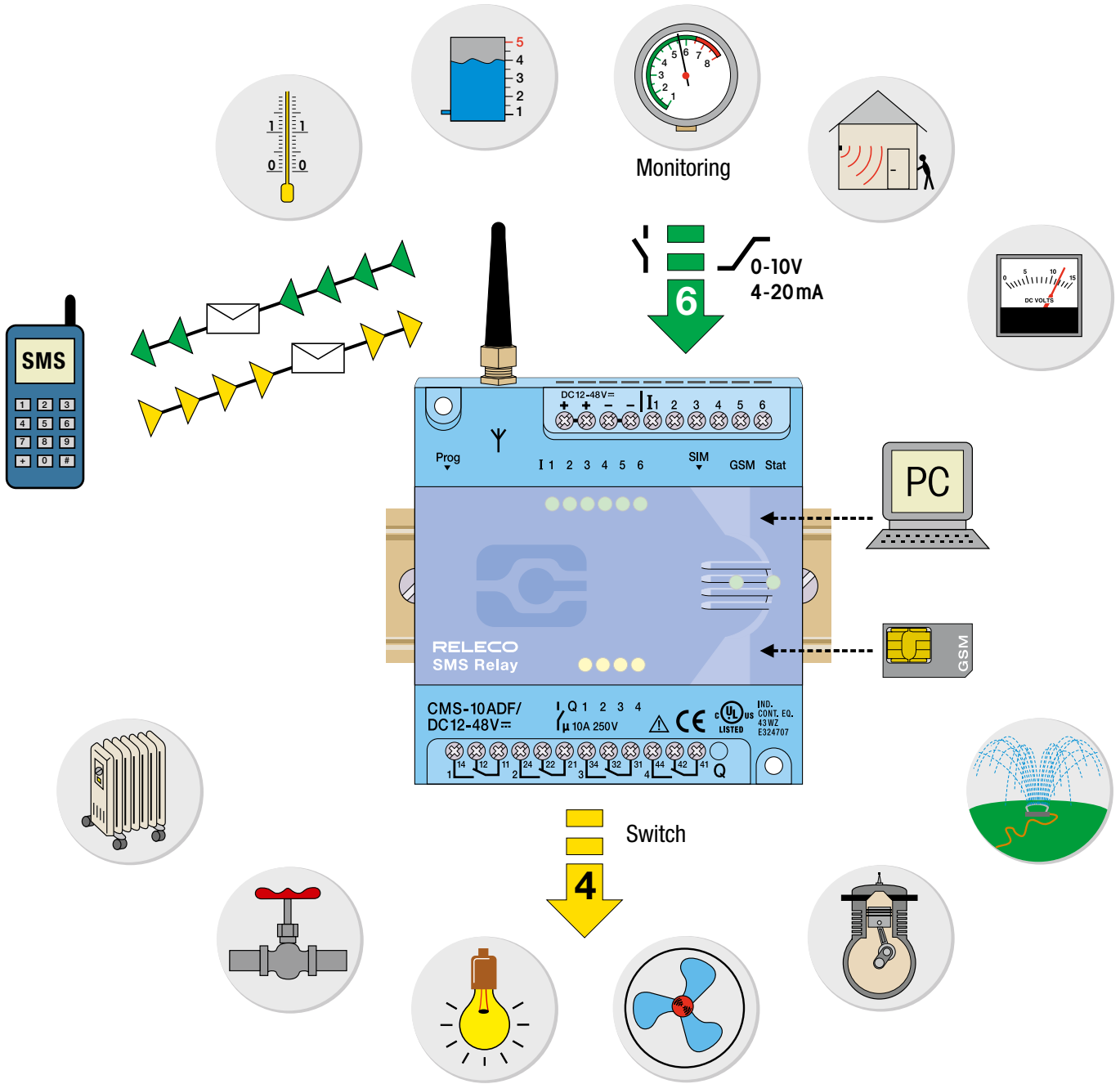
1.3 Automation Relays

1.3.1 Remote Control Relay

SMS Relay



- ✓ Easy configuration with PC and «FAST SMS SET™»-up configuration software
- ✓ Sequential alert messaging to 5 different subscribers
- ✓ Analog and/or digital inputs
- ✓ Monitoring of all inputs and outputs with SMS messaging
- ✓ Request of analogue values by SMS
- ✓ Remote control of outputs by SMS
- ✓ Power failure notification by SMS messaging
- ✓ Status change messages by SMS
- ✓ User defined message text
- NEW** ✓ Remote access and status display by PC/Notebook
- NEW** ✓ Call-In Function
- NEW** ✓ Alarm messages by e-mail
- NEW** ✓ App for Android operated smartphones



Monitoring
Alerting
Controlling

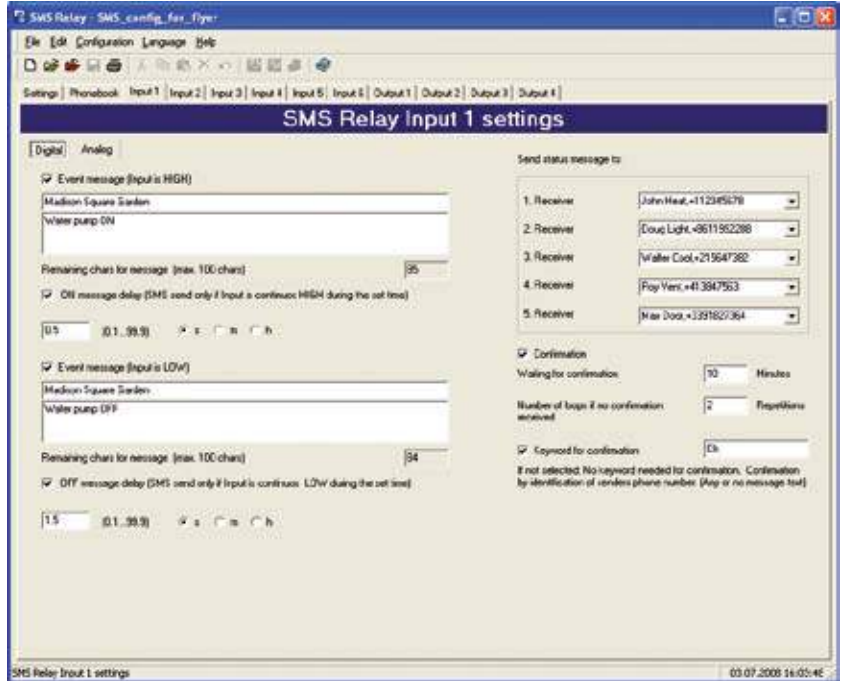
Alerting,
Controlling
Monitoring

Controlling
Monitoring
Alerting



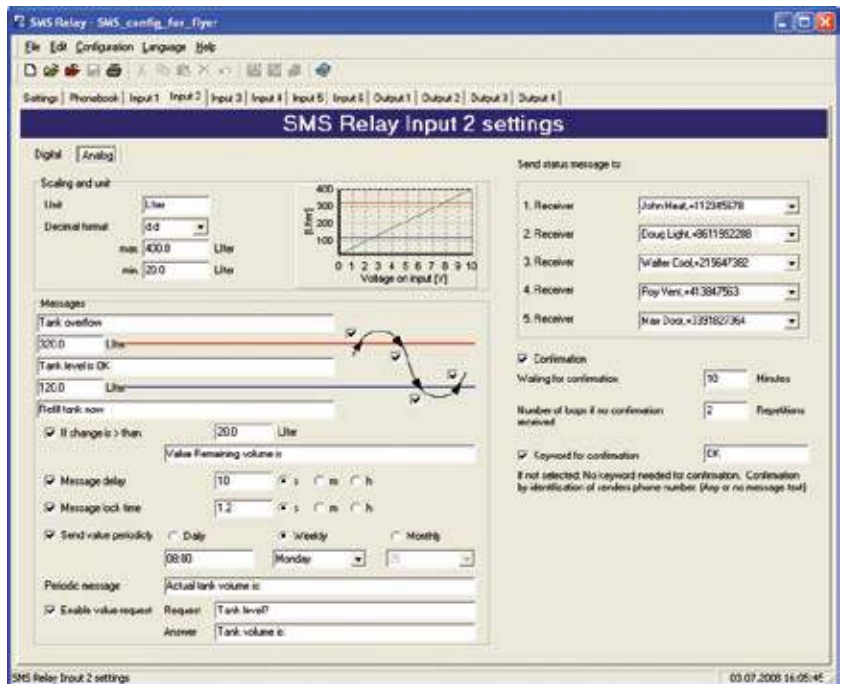
Digital Inputs

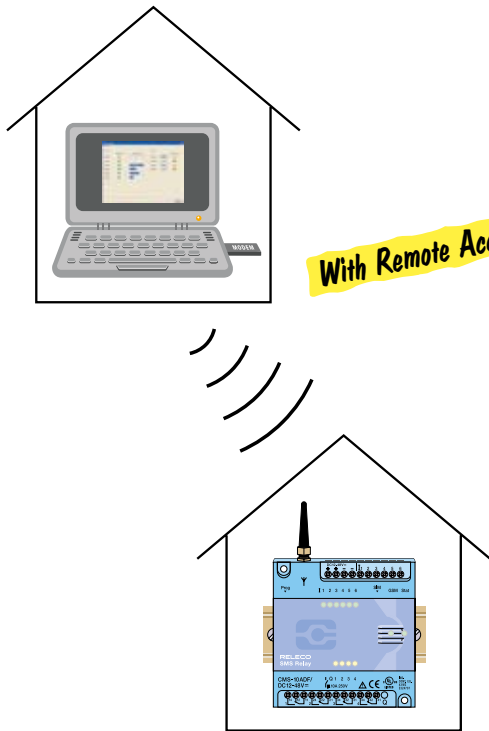
Language



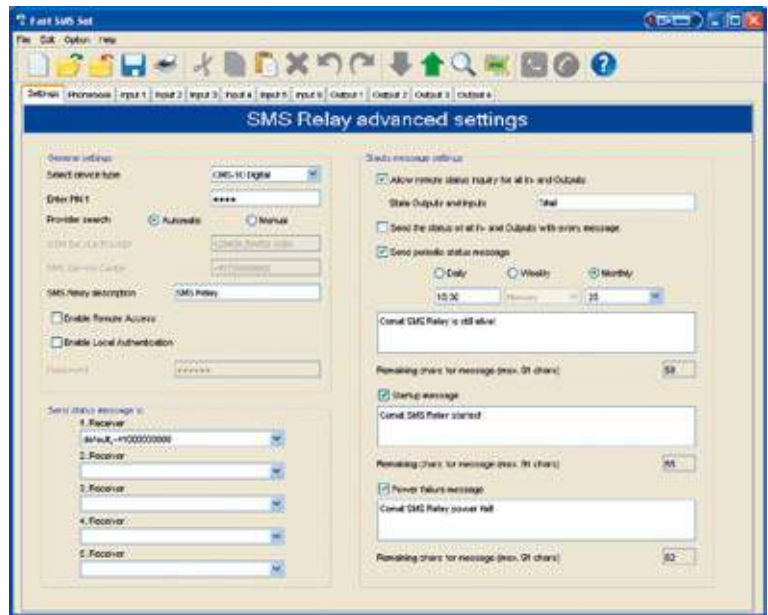
Analog Inputs

- ✓ Free selectable units e.g.: l, kg, m³, psi, F, sqm, lbs
- ✓ Any min/max value can be defined. Scale adjustment automatic
- ✓ Value inquire by SMS
- ✓ Automatic alerting if min/max values are exceeded
- ✓ Status display on PC/Notebook via GSM network

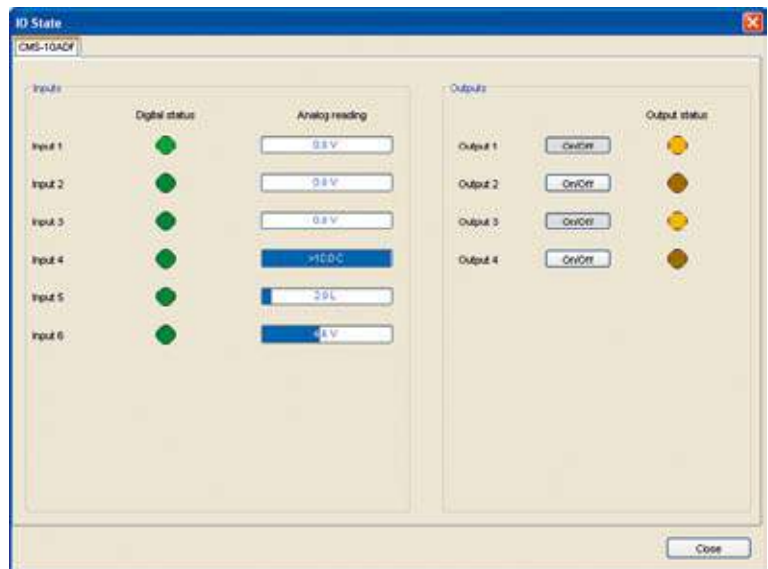




Basic settings



Status display on the PC screen



Remote maintenance

The option "remote access" allows users to change the device configuration without presence on site.

The connection with a serial cable is replaced with the communication over the GSM network.

For that purpose, the user has to establish communication with the SMS Relay via a GSM modem. (for example with CMS-GSM-MOD) connected to the PC.

As soon as the connection between the PC and the device is established, a new configuration can be downloaded or the existing configuration may be read out. This allows to simply save or change a phone number of a message receiver or to modify an analogue value or a time setting.


With the new configuration software it is also possible to display all Input and Output status as well as to switch Outputs without sending an SMS message to the device.

It has to be noted that establishing of communication and data transfers in the GSM network are subject of charges. These costs are variable depending on the provider and subscription. We recommend to keep the connection as short as possible.

The easy and comfortable handling of the SMS Relay is not affected with the new functions. The configuration software "FAST SMS SET" has not changed significantly and remains easy to use.

NEW

Technical Data's

Typ	CMS-10F/AC 110-240V	CMS-10F/DC12-48V	CMS-10ADF/DC12-48V	CMS-10ACDF/DC12-48V
Operating voltage	AC 110-240V~ 50/60Hz	DC 12-48V= max. 10%	DC 12-48V= max. 10%	DC 12-48V= max. 10%
Power consumption	8VA/6W	4,2W	4,2W	4,2W
Switching capacity 	4 x 10A 250V; Sum of current max. 20A			
Temperature range	Tu: -25...+55° C; Rel. humidity: 10...95% (non condensing); Protection IP20			
Inputs	6 x digital (trigger level 85V~)	6 x digital (trigger level 9,5V=)	6 x digital and/or analog (trigger level 9,5V=) (analog 0-10V=)	2 x analog (4-20 mA) 4 x digital and/or analog (trigger level 9,5V=) (analog 0-10V=)
Outputs	4 x CO contacts μ 10A/250V AC-1			
Provider (Phone/Network)	User selectable (dependent on SIM card)			
Frequency	GSM QuadBand (850; 900; 1800; 1900MHz)			

Installation note

The base unit device is delivered fully operational and includes the small aerial CMS-ANT.

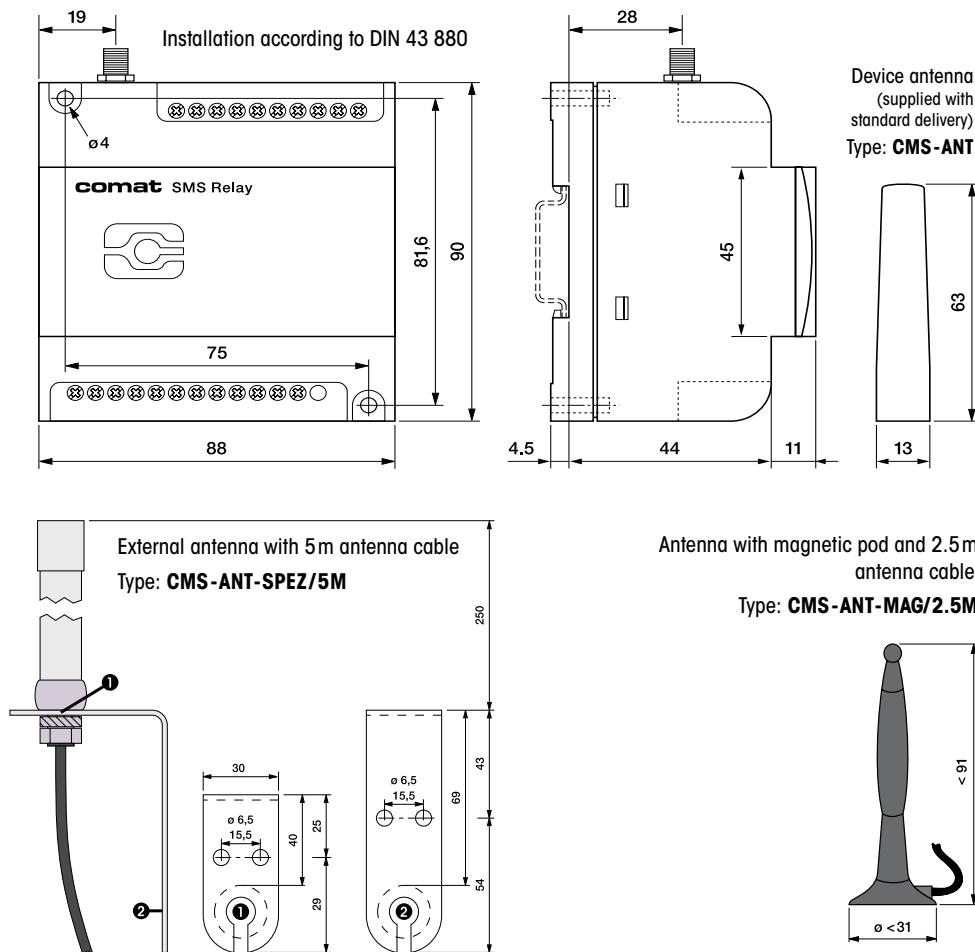
Before installation, the final location of installation must be taken into consideration.

For installation inside a control panel, the small device aerial may not be suitable and needs to be replaced by the antenna with magnetic pod (CMS-ANT-MAG/2.5M) or by the external antenna (CMS-ANT-SPEZ/5M).

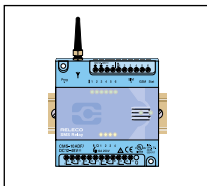
These two antennas provide considerably better results and improve communication with the mobile network.

Please ask our product specialists if you require any support.

Dimensions



Typ	Description
CMS-10F/AC110-240V	SMS Relay AC 110-240V with 6 digital inputs incl. small antenna (CMS-ANT)
CMS-10F/DC12-48V	SMS Relay DC 12-48V with 6 digital inputs incl. small antenna (CMS-ANT)
CMS-10ADF/DC12-48V	SMS Relay DC 12-48V with 6 digital and analog inputs incl. small antenna (CMS-ANT)
CMS-10ACDF/DC12-48V	SMS Relay DC 12-48V with 2 analog current inputs and 4 analog and/or digital voltage inputs, incl. small antenna (CMS-ANT)
KIT consisting of: A base unit with small antenna, antenna with magnetic pod and 2.5 m cable, programming cable, USB-RS232 Interface connector, CD with «FAST SMS SET™»-up programming software and operation manual	
CMS-10FKIT/AC110-240V	Installation kit complete with 6 digital inputs (SMS Relay AC110-240V)
CMS-10FKIT/DC12-48V	Installation kit complete with 6 digital inputs (SMS Relay DC12-48V)
CMS-10ADFKIT/DC12-48V	Installation kit complete with 6 digital and/or analog inputs (SMS Relay DC12-48V)
CMS-10ACDFKIT/DC12-48V	SMS Relay Kit DC 12-48V with 2 analog current inputs and 4 analog and/or digital voltage inputs
Accessories	
CMS-RS232	SMS Relay programming cable RS232
CMS-USB	USB-RS232 interface connector (including driver CD)
CMS-ANT	Small spare antenna for base unit, 63 mm long
CMS-ANT-MAG/2.5M	Antenna with magnetic pod and 2.5 m antenna cable
CMS-ANT-SPEZ/5M	External antenna with 5 m antenna cable
CMS-ANT-KAB/5M	Antenna cable 5 m (extension)
CMS-ANT-KAB/10M	Antenna cable 10 m (extension)
CMS-ANT-ADAPT	Adaptor FME to SMA plug
CMS-CAP	Device cover (spare)
CMS-CD	CD with FAST SMS SET-up programming software and manual
DR-15-24	Power supply 15W, 24V. DIN-rail mounting
DR-30-24	Power supply 36W, 24V. DIN-rail mounting
4114 PReasy	Universal transmitter PReasy 4114
4501	Display front (to PReasy 4114)
ZPT-10-H	PT100/PT1000 Amplifier
RF01-U	Room temperature sensor 0...50°C without display
RF01-U-D	Room temperature sensor 0...50°C with display
RTBSB-001-010	Room thermostat 5...30°C with operating controls
WF50 ext-U	Outdoor temperature sensor -50...+50°C
KS-110	AC sensor for monitoring of humidity and temperature in control panels, archives and cabinets
PS1	Water gauge suitable for application of level measurements in water installations
CMS-GSM-MOD	GSM Module (Connected to USB port of the PC) for remote access to the SMS Relay



Type

CMS-10F/...
CMS-10ADF/...
CMS-10ACDF/...

SMS Relay

- SMS Relay incl. small antenna 63 mm
- WITHOUT programming cable, magnetic pod antenna, USB converter and programming software
- Suitable for user which already possess the accessories



CMS-10FKIT/...
CMS-10ADFKIT/...
CMS-10ACDFKIT/...

SMS Relay KIT

- SMS Relay incl. small antenna 63 mm
- Including programming cable, magnetic pod antenna with 2.5 m cable, USB converter USB-RS232, and programming software "FAST SMS SET™" with manual
- Suitable for user first user

Type



DR-15-24

Power supply

- Input
 - Voltage range: 85-264 V AC, 120-370V DC
 - Frequency range: 47-63 Hz
 - Max. current: 0,88 A
- Output
 - DC Nominal voltage: 24 V
 - Setting range: 21,6-26,4 V
 - Power range: 0-0,63 A
 - Nominal load: 15,2 W



DR-30-24

Power supply

- Input
 - Voltage range: 85-264 V AC, 120-370V DC
 - Frequency range: 47-63 Hz
 - Max. current: 0,88 A
- Output
 - DC Nominal voltage: 24 V
 - Setting range: 21,6-26,4 V
 - Power range: 0-1,5 A
 - Nominal load: 36 W



4114 PReasy

Universal transmitter

- Input
 - Current: 0/4...20 mA
 - Voltage: 0/0,2...1; 0/1...5; 0/2...10V DC
 - PT100: 2-, 3- and 4 wire
 - TE types: B...W5
 - Potentiometer: 10Ω...100kΩ
 - Lin. Resistance: 0Ω...10kΩ
- Output
 - Current: 0/4...20 mA / 800Ω
 - Voltage: 0/0,2...1; 0/1...5; 0/2...10V DC



4501

Display/Programming panel for PReasy

- Communication interface for setting of operative parameters
- Can be plugged from one device to the other for data transmission
- Stationary display to visualize status of process data
- Password protected
- LCD display with 4 lines



ZPT-10-H

PT100/PT1000 Amplifier

- Input: PT100; PT1000: 2-, 3-line switching
- Output: 0...10V DC
- Supply voltage: 15...35V DC
- DIN rail mounting



RF01-U

Room temperature sensor without display

- Integrated transducer
- Output: 0...10V DC
- Measuring range: 0°C...50°C
- Supply voltage: 24 V DC

Type



RF01-U-D Room temperature sensor with integrated display

- Integrated transducer
- Output: 0...10V DC
- Measuring range: 0°C...50°C
- Supply voltage: 24V DC



RTBSB-001-010 Room thermostat with operating controls

- Suitable for temperature monitoring in closed rooms
- Output: 1 CO
- Setting range: 5°C...30°C
- Supply voltage: 230V AC (24V DC)



WF50 ext-U Outdoor temperature sensor

- Sensor for temperature measuring outdoors or in industrial storage- or cold chambers
- Output: 0...10V DC
- Measuring range: -50°C...+50°C
- Supply voltage: 15...24V DC
- Protection class: IP65



KS-110 AC sensor for indoors and outdoors

- Measuring of humidity and temperature in control panels, archives and cabinets
- **Temperature**
 - Measuring range: -40°C...+80°C
 - Measuring element: Solid state
 - Output: 0-10V
- **Humidity**
 - Measuring range: 0%...100% relative humidity
 - Measuring element: Capacitive
 - Output: 0-10V



PS1 Level and water gauge

- Suitable for applications in fountains or in water installations up to a depth of 5m (0-0.5 bar) Additional measuring ranges on request.
- Cable in special design with pressure compensation line
- Output signal: 0-10V, 3-wire
- Application temperature: +5°C bis +70 °C



CMS-GSM-MOD Recommended modem for remote communication with the SMS Relay

QuadBand (850/900/1800/1900 MHz)
Supports GPRS, CSD, CSF and SMS
USB 2.0 Full speed (12 Mbits/s) interface
With driver for Windows 2000/XP/XPPro/Tablet and Linux



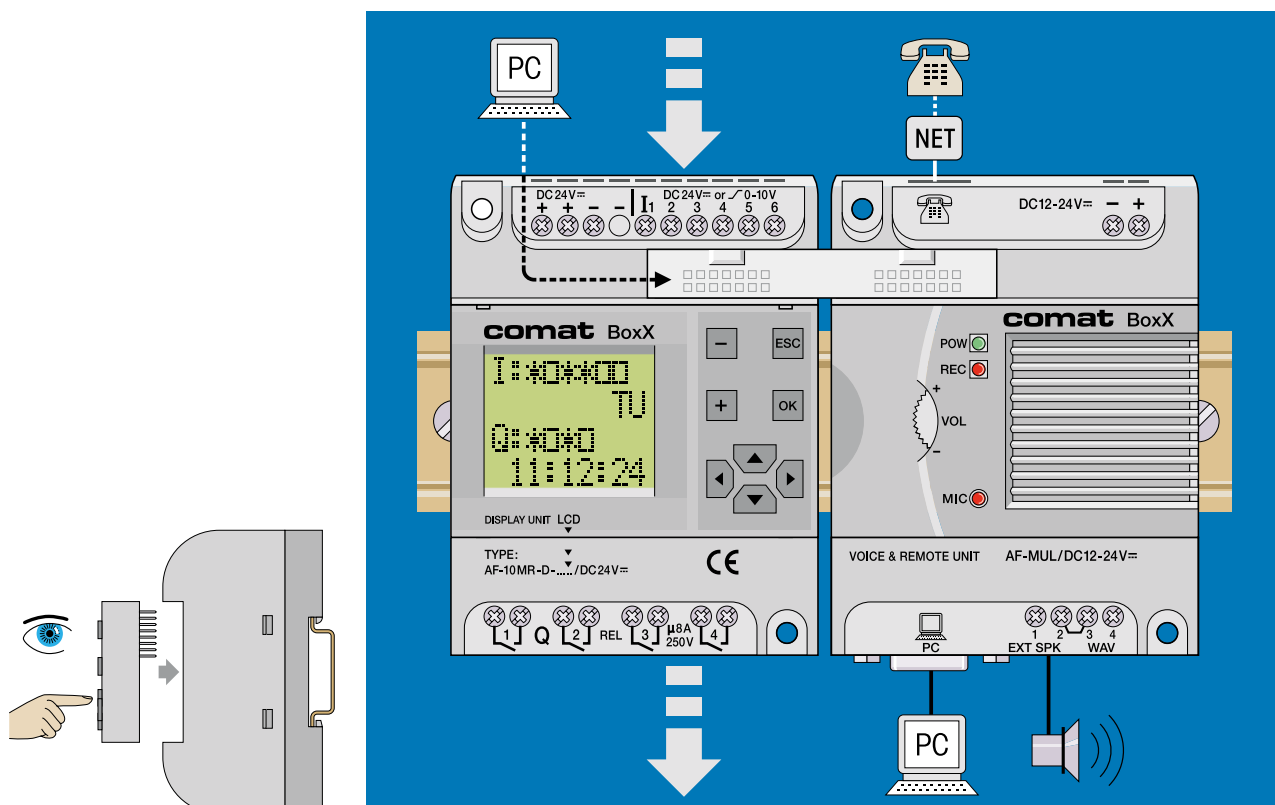
App SMSrelay App for Android operated smart phones

The App is available free of charge in the Android Market with its designation "SMSrelay"

Our SMS Relay is very suitable also for applications with products of EnOcean technology
With accessories of this innovative solar powered wireless technology, these sensors can be used anywhere without expensive wiring.
All above products are available from Comat AG. Don't hesitate to contact us.

1.3.2 Smart Relay

Smart Relay "BoxX" Miniature Controller (with Voice Module)



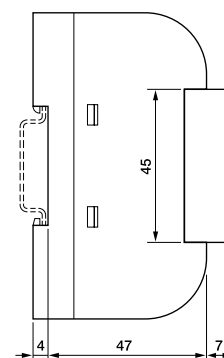
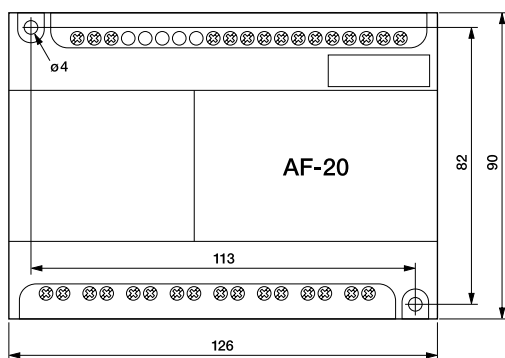
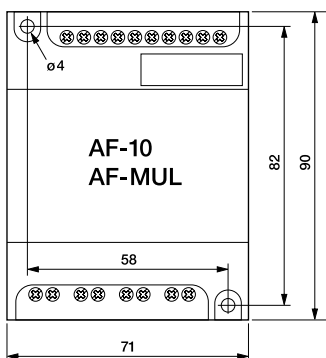
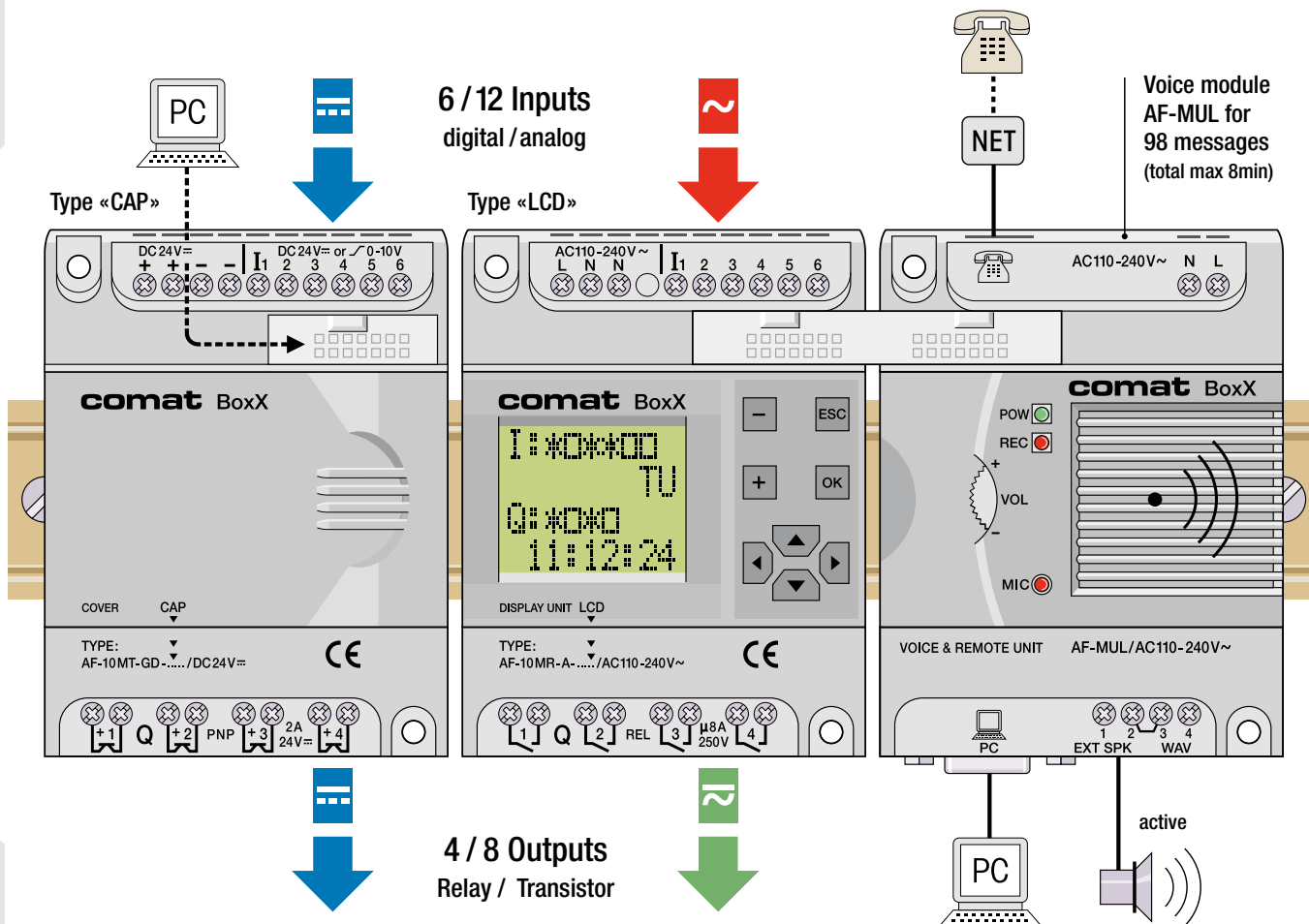
- Programming via PC
- Remote controlling and voice message over telephone network
- Comprehensive function block library
- Password protected

The Controller

127

Function blocks
Intermediate relays
Timer instructions
(up to the year 2099)

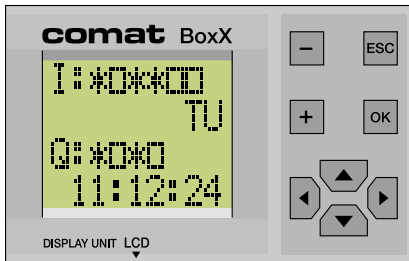
- Program storage 64 kByte
- Time range 0,01s-99,99h
- Counting values 1-999'999
- System timer back up 100h



The Application

The Comat BoxX can be programmed by PC or with the snap-on LCD display with integrated function keys. It is possible to modify time intervals of the function blocks in the existing control program on site directly on installation. The LCD display can be connected to the Comat BoxX to visualize conditions or may be removed (without voltage) and used on another Comat BoxX.

The 24V versions of the Comat BoxX can also process analogue input signals 0...10V with increments of 0.1V. All inputs can be used or configured at random as analogue or digital inputs. Function blocks for the comparison of analogue values are available, i.e. to monitor temperature in a heating system.



Setting the display

Analogue inputs



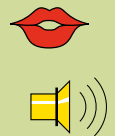
Programming software

The programming software QUICK II allows easy and transparent programming of the Comat BoxX with a PC. QUICK II is based on Windows®. 127 function blocks can be stored inside the program memory of the Comat BoxX. Stored programs cannot be lost even during a power loss. Therefore back up batteries are not needed. With the simulation tool, the set up can be tested on the PC before commissioning. Example: next page

Programming the function blocks

Control tasks can be solved easily with the function blocks available in the library. Programming codes in a highlevel program language are not required. Simply place the corresponding function blocks and link them with other function blocks according to the required control function.

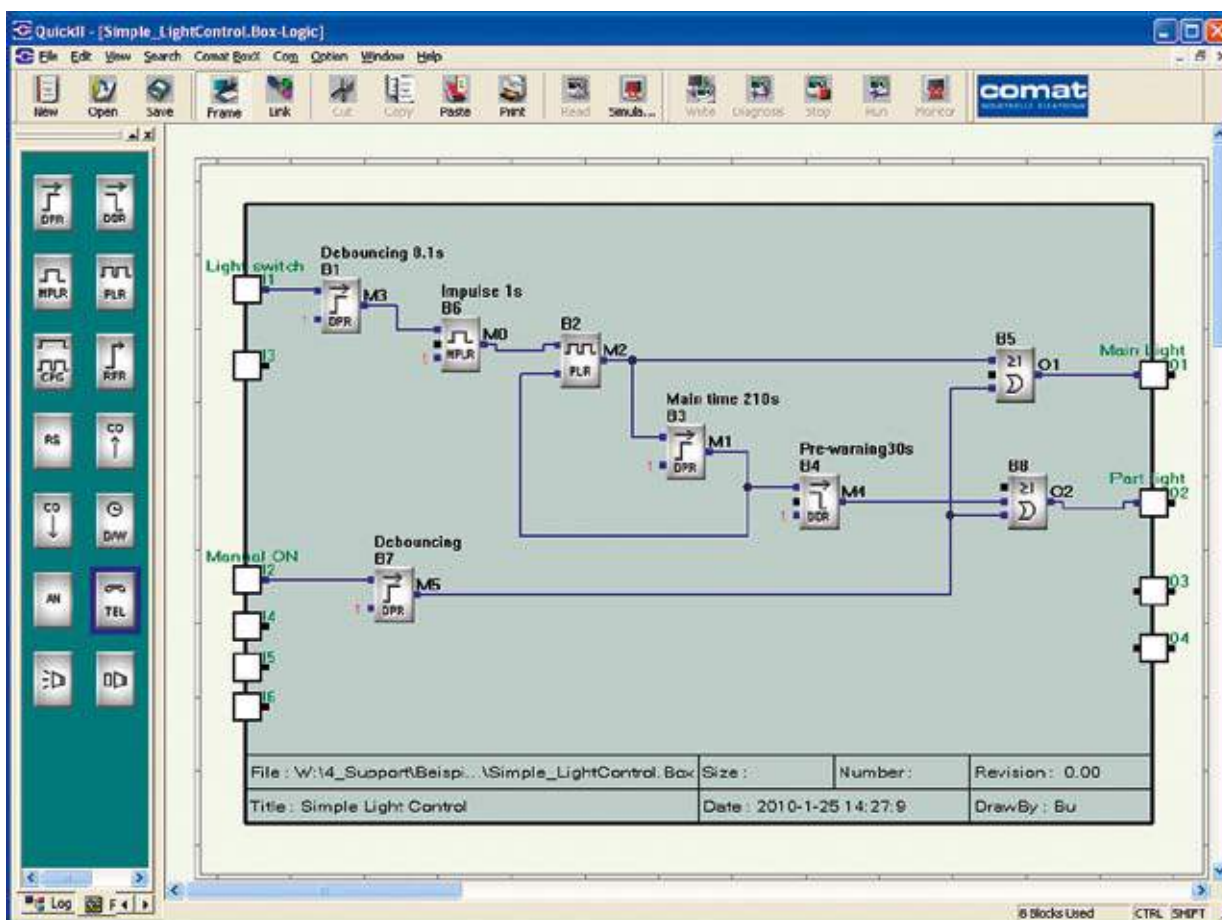
The voice and remote module



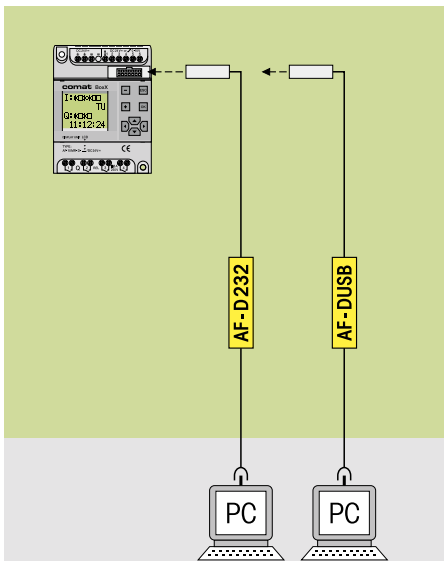
The voice module allows the playing of messages through either the built-in or external loud speakers. The voice module also replays phone calls or dials phone numbers to send emergency or status messages. Messages are recorded directly over the built-in microphone or are transferred as*.wav files directly from the PC.

Programming software Quick II

Example: Programming environment

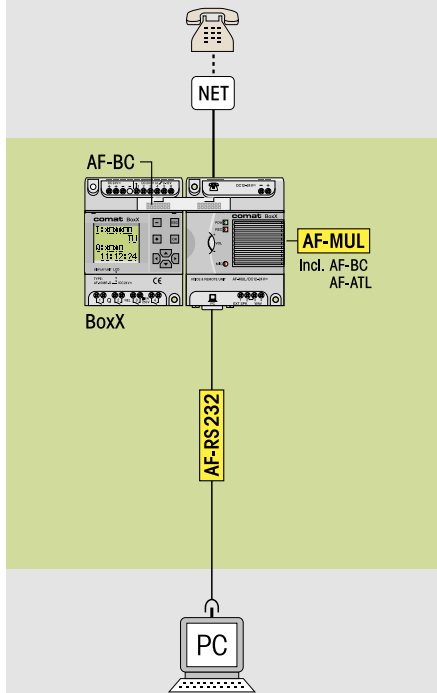


The Extension module



Programming simulation and monitoring with the PC.

Programming via the MUL voice and remote unit



Each Comat BoxX can be controlled via a telephone line if connected to the extension module AF-MUL (voice & remote unit).

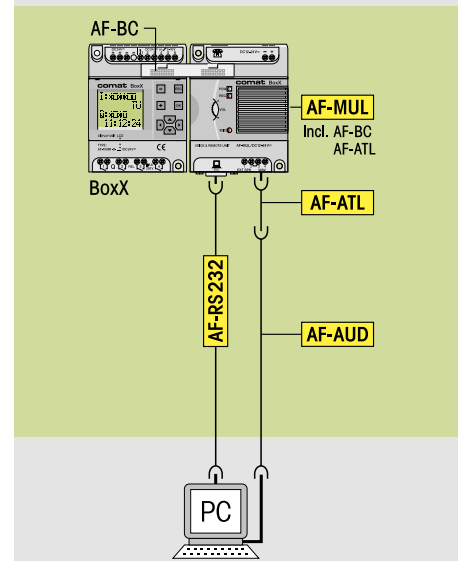
The AF-MUL will answer calls and allows access after the password is accepted.

The Comat BoxX with the AF-MUL is able to record up to 98 predefined conditions, for example alarm messages over the phone network. The designated phone number is dialled and the recorded message is played over the telephone.

The message can also be broadcasted over auxiliary loudspeakers.

At the same time, the controller can be remotely accessed by phone, and phone Keys are used to send remote signals to control the installation or to activate controlling steps.

Recording of messages with the PC



Messages are transferred to the voice module as *.wav files directly from the PC over the AF-AUD cable.

The Types

<p>6/12 Inputs digital AC110-240V</p> <p>4/8 Outputs relays 8A 250V ~</p>	<p>6 INPUTS 4 OUTPUTS</p>	<p>12 INPUTS 8 OUTPUTS</p>
	<p>AC110-240V</p>	<p>AC110-240V ~</p>
<p>AC110-240V ~</p>	<p>AC110-240V ~</p>	
<p>6/12 Inputs digital AC110-240V</p>	<p>comat BoxX AF-10MR-A-...</p>	<p>comat BoxX AF-20MR-A-...</p>
<p>4/8 Outputs relays 8A 250V ~</p>	<p>RELAY μ8A 250V Q1 Q2 4x Q4</p>	<p>RELAY μ8A 250V Q1 Q2 8x Q8</p>
<p>Order no.</p>	<p>without display AF-10MR-A-CAP/AC110-240V with display AF-10MR-A-LCD/AC110-240V</p>	<p>without display AF-20MR-A-CAP/AC110-240V with display AF-20MR-A-LCD/AC110-240V</p>
<p>6/12 Inputs configurable: digital / analog 0-10V (0,1V)</p> <p>4/8 Outputs relays 8A 250V ~</p>	<p>DC24V=</p>	<p>DC24V= or 0-10V</p>
	<p>DC24V=</p>	<p>DC24V= or 0-10V</p>
<p>6/12 Inputs configurable: digital / analog 0-10V (0,1V)</p>	<p>comat BoxX AF-10MR-D-...</p>	<p>comat BoxX AF-20MR-D-...</p>
<p>4/8 Outputs relays 8A 250V ~</p>	<p>RELAY μ8A 250V Q1 Q2 4x Q4</p>	<p>RELAY μ8A 250V Q1 Q2 8x Q8</p>
<p>Order no.</p>	<p>without display AF-10MR-D-CAP/DC24V with display AF-10MR-D-LCD/DC24V</p>	<p>without display AF-20MR-D-CAP/DC24V with display AF-20MR-D-LCD/DC24V</p>
<p>4/8 Transistor outputs PNP 2A 24V =</p>	<p>PNP 2A 24V=</p>	<p>PNP 2A 24V=</p>
	<p>PNP 2A 24V=</p>	<p>PNP 2A 24V=</p>
<p>Order no.</p>	<p>without display AF-10MT-GD-CAP/DC24V with display AF-10MT-GD-LCD/DC24V</p>	<p>without display AF-20MT-GD-CAP/DC24V with display AF-20MT-GD-LCD/DC24V</p>

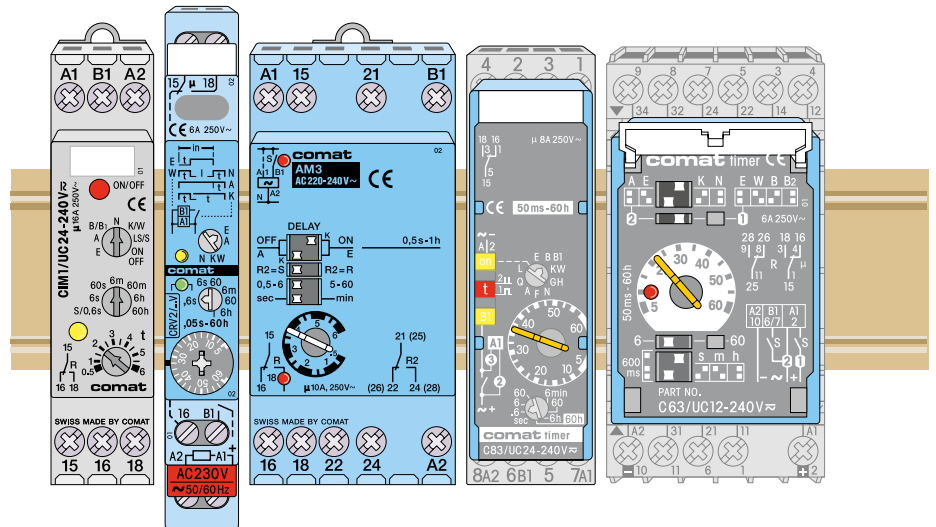
Accessories

<p>Order no.</p> <p>AF-MUL/AC110-240V Voice and remote unit ¹⁾</p> <p>AF-MUL/DC12-24V Voice and remote unit ¹⁾</p> <p>AF-RS232 AF-MUL Programming cable</p> <p>AF-BC AF-MUL Bridge connector ²⁾</p> <p>AF-ATL AF-5MUL Audio Cable ²⁾</p> <p>AF-AUD Audio Cable</p> <p>DR-15-24 Power supply 15W, 24V</p> <p><small>¹⁾ Inclusive AF-BC and AF-ATL ²⁾ Included with AF-MUL</small></p>	<p>Order no.</p> <p>AF-D232 Programming cable (RS 232)</p> <p>AF-DUSB Programming cable (BoxX/USB)</p> <p>CMS-USB Converter USB- RS 232</p> <p>AF-LCD Display with function keys</p> <p>AF-CAP Cover (instead of AF-LCD)</p> <p>AF-CDR CD-ROM</p>
---	---

The Data

	AF-10	AF-20	AF-MUL
Operating voltage U _B	AC110-240V ~ 50/60Hz DC24V= max. 10%	AC110-240V ~ DC12-24V=	AC110-240V ~ DC12-24V=
Power consumption	Transistor: 2W Relay: 4W	Transistor: 2W Relay: 5W	0,7W
Switching power	8A 250V ~	2A 24V=	
Ambience conditions	T _u without display -25...+55°C T _u with display 0...+55°C	Rel. humidity: 5...95% (non condensing)	Protection IP20

Time Relays



Delay functions

E On delay

 $S \Rightarrow R$ on with delay
 $S_{OFF} \Rightarrow R$ off

A Off delay

 $S \Rightarrow R$ on
 $S_{OFF} \Rightarrow R$ off with delay

F On and off delay

 $S \Rightarrow R$ on with delay (t_1)
 $S_{OFF} \Rightarrow R$ off with delay (t_2)

Shot timing modes

W One shot leading edge

 $S \Rightarrow R$ on for t
 $S_{OFF} \Rightarrow R$ off (pulse clipping)

N One shot trailing edge

 $S_{OFF} \Rightarrow R$ on for t
 S on for t $\Rightarrow R$ off

Q One shot leading and trailing edge

 $S \Rightarrow R$ on for t_1
 $S_{OFF} \Rightarrow R$ on for t_2
 S_{OFF} off for $t_1 \Rightarrow R$ off

Puls shaping

K Puls shaping

 S (pulse or continuous contact) $\Rightarrow R$ on for t
 S_{--} no influence on R and t

L Pulse shaping, retrigger (subsequ.time operation from 0)

 S (pulse or continuous contact) $\Rightarrow R$ on for t
 S on for t = tRESET

M Puls shaping

 $S_{OFF} \Rightarrow R$ on for t
 S_{--} no influence on R and t

Blinker functions

B Blinker, pulse start

 $S \Rightarrow R$ on/off periodically according to t
 $S_{OFF} \Rightarrow R$ off

B1 Blinker, pulse start, trailing pulse

 $S \Rightarrow R$ on/off periodically according to t
 S_{OFF} : last pulse = t

B2 Blinker, interval start

 $S \Rightarrow R$ after t on/off periodically according to t
 $S_{OFF} \Rightarrow R$ off

Delayed pulse

G On delay single shot

 S (pulse or continuous contact) $\Rightarrow R$ after t_1 on for t_2
 S_{--} no influence on R and t

H On delay single shot

 $S \Rightarrow R$ after t_1 on for t_2
 $S_{OFF} \Rightarrow R$ off

Repeat cycle timer

I Repeat cycle timer, pulse start

 $S \Rightarrow R$ on/off periodically according to t_1 and t_2
 $S_{OFF} \Rightarrow R$ off

P Repeat cycle timer, interval start

 $S \Rightarrow R$ after t_1 (t_2) on/off periodically according to t_2 and t_1
 $S_{OFF} \Rightarrow R$ off

Special functions

Y Star-delta timer

 $S \Rightarrow \Delta$ on for t
 $\Delta_{OFF} \Rightarrow \Delta$ on with delay for t
 $S_{OFF} \Rightarrow \Delta$ off

X1 Restart delay

 $S \Rightarrow R$ on
 $S_{OFF} \Rightarrow R$ off and starts t
 $S \Rightarrow R$ restart only after t

Special functions

S Step-on / Step-off switch

 $S \Rightarrow R$ on/off

LS Step-switching (staircase lighting timer), with time lapse

 $S \Rightarrow R$ on and starts t
 S on for t $\Rightarrow R$ off

Stop / Reset

tSTOP SSTOP interrupts t (t-addition) **T** t is stopped $\Rightarrow R$ on/off

tRESET SRESET reset t t restarts immediately **T** Test

S = Triggering
 R = Output circuit
 \Rightarrow = switches...

Pulse sequence monitoring

U
 S_1/S_2 P (t_P)

V
 S_1/S_2 P (t_P)

\leq : Pulse separation is **smaller** than the time t_P
 $>$: Pulse separation is **larger** than the time t_P

Start with **S1** = **without** start-up short-out t_A
 Start with **S2** = start-up short-out t_A

t_V = settable alarm delay delay ($t_A = t_V$)

012019e

Time Cubes



Typ	Funktion																t-Stop	t-Reset	Ext. Polt	t max.											
	E	A	F	W	N	Q	K	L	M	B	B ₁	B ₂	G	H	I	P				S	LS	X ₁	U	V	sec	min	h	Tage	Seite		
CT...E 30	●																										30			133	
CT...A 30		●																										30			133
CT...K 30				●				●																				30			133
CT...W 30				●																								30			133
CT...B 30										●																		30			133

Modular plug-in Time Relays (CT-System)



Typ	Funktion																t-Stop	t-Reset	Ext. Polt	t max.											
	E	A	F	W	N	Q	K	L	M	B	B ₁	B ₂	G	H	I	P				S	LS	X ₁	U	V	sec	min	h	Tage	Seite		
CT30...	●				●					●																		30			137
CT32...	●	●			●	●			●		●																	60*			137
CT33...	●	●	△		●	●	△		●	●			▲	▲															60*		137
CT36...															●	●												60*			137

Plug-in Time Relays



Typ	Funktion																t-Stop	t-Reset	Ext. Polt	t max.											
	E	A	F	W	N	Q	K	L	M	B	B ₁	B ₂	G	H	I	P				S	LS	X ₁	U	V	sec	min	h	Tage	Seite		
C83	●	●	△		●	●	△		●	●			▲	▲															60*		146
C84		■			■																							20			147
C85			●			●							●	●	●	●													60*		148
CS1	●				●					●		●																60*			154
CS2	●	●			●	●			●		●																		60*		155
CS3	●	●			●	●			●		●																		60*		156
C63	●	●			●	●			●		●																		60*		149
C64		■			■																							20			150
C55	●	●	●		●	●			●		●			●	●	●					●	●	●						60		151
C56	●	●	●		●	●			●		●			●	●	●					●	●	●						60		153

DIN Time Relays

DIN

Typ	Funktion																t-Stop	t-Reset	Ext. Polt	t max.											
	E	A	F	W	N	Q	K	L	M	B	B ₁	B ₂	G	H	I	P				S	LS	Y	U	V	sec	min	h	Tage	Seite		
CIM1	●	●			●	●				●	●						●	●											60*		159
CIM12	●	●			●	●				●	●						●	●											60*		160
CIM13	●	●			●	●				●	●						●	●											60*		161
CIM2	●	●						●	●			●	●																60*		162
CIM22	●	●						●	●			●	●																60*		163
CIM23	●	●						●	●			●	●																60*		164
CIM3			●			●							●	●	●	●													60*		165
CIM32			●			●							●	●	●	●													60*		166
CIM33			●			●							●	●	●	●													60*		167
CM3	●	●			●	●				●	●																		60*		168
CRV2	●	●			●	●				●																			60*		169
CRV3			●			●																							2x60*		170
GSV2	●	●			●	●				●																			10*		171
AM2	●	●			●					●																			60		172
AM3 ¹⁾	●	●			●					●																			60		173
CNR1		■			■																								12		174
CPF11		●						●	●																		0,6				175
CY1																					●							60			176

* TF-60 Setting of long times

The TF60 time setting method permits short examination of long delay time settings. Elapsing times of hours can be monitored in the sec. range.

Example for a delay time of 38h:

1. Set range switch to 60sec
 2. Set 38sec on the potentiometer
(e.g. check 38sec by chronometer)
 3. Set range switch to 60h
- The delay time now amounts to 38h.

- ¹⁾ alternatively with instantaneous contact
- without auxiliary voltage (relay bistable)
- without auxiliary voltage (relay monostable)

- △ t₂ = t₁
- ▲ t₂ = 0,5s

2.1 Time Cubes

Timecube



Type: CT2: 8 pole, CT3: 11 pole

The CT2 or CT3 Timecube® is an electronic timer that is inserted between the plug-in industrial relay and the socket. This combination is a modular complete time relay without additional space requirement. It offers up to three changeover contacts with a variety of signal contacts and power contacts.

The Timecubes® are suitable for all 8 pin and 11 pin standard industrial relays of the C2 and C3 series according to IEC 67 and also for relays of other manufacturers.



Time functions (Function diagrams: refer to page 130)

Operating voltage controlled types

- CT2- / CT3-E30: Function E, on delay
- CT2- / CT3-W30: Function W, one shot
- CT2- / CT3-B30: Function B, blinker

Trigger input controlled types

- CT2- / CT3-A30, off delay
- CT2- / CT3-K30, pulse shaping

Time data

4 partial time ranges (DIP switch)



Fine adjustment time range (rotary knob)

$t_{min} \dots t_{max}, 2 \dots 30$

Time range tolerance

$t_{min}: 0 \dots + 35 \%$

Repetition accuracy

$\pm 0.5 \%$ or ± 20 ms

Reset time

≤ 200 ms

Reset time B1 (trigg. inp.) A, K

≤ 80 ms

Voltage failure buffering

5 ms (except the relay)

Power supply- and control input (UC = AC or DC)

CT2- / CT3- ... / S	DC 9.5 ... 18 V	12 mA
CT2- / CT3- ... / L	UC 20 ... 65 V	6 mA
CT2- / CT3- ... / M	UC 90 ... 150 V	2 mA
CT2- / CT3- ... / U	UC 180 ... 265 V	2 mA
CT2- / CT3- ... / H	UC 90 ... 265 V	2 mA
Residual current E, W, B	≤ 0.3 mA	
Residual current B1 (trigg. inp.) A, K	≤ 0.2 mA	

General specifications

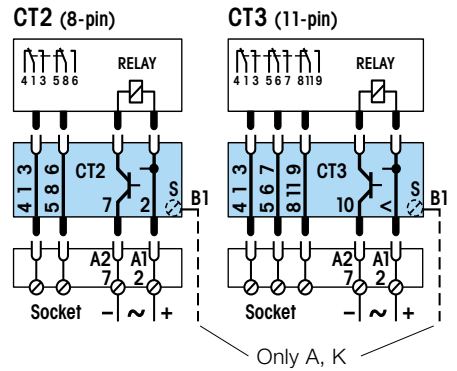
Ambient temperature storage / operation	-40 ... +70 °C / -25 ... +60 °C
Ingress protection degree	IP40
Housing material	Lexan
Weight	35 g

Standard types

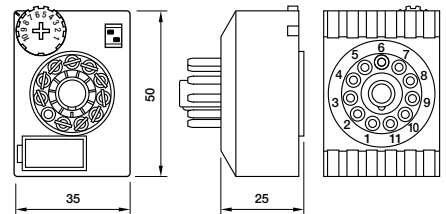
UC 50 Hz / 60 Hz: 20 ... 265 V
DC 12 V

8 pole	11 pole	Voltage
CT2-E30/S CT2-W30/S CT2-B30/S CT2-A30/S CT2-K30/S	CT3-E30/S CT3-W30/S CT3-B30/S CT3-A30/S CT3-K30/S	DC 9.5...18 V
CT2-E30/L CT2-W30/L CT2-B30/L CT2-A30/L CT2-K30/L	CT3-E30/L CT3-W30/L CT3-B30/L CT3-A30/L CT3-K30/L	UC 20...65 V
CT2-A30/M CT2-K30/M	CT3-A30/M CT3-K30/M	UC 90...150 V
CT2-A30/U CT2-K30/U	CT3-A30/U CT3-K30/U	UC 180...265 V
CT2-E30/H CT2-W30/H CT2-B30/H	CT3-E30/H CT3-W30/H CT3-B30/H	UC 90...265 V

Wiring diagram



Dimensions [mm]



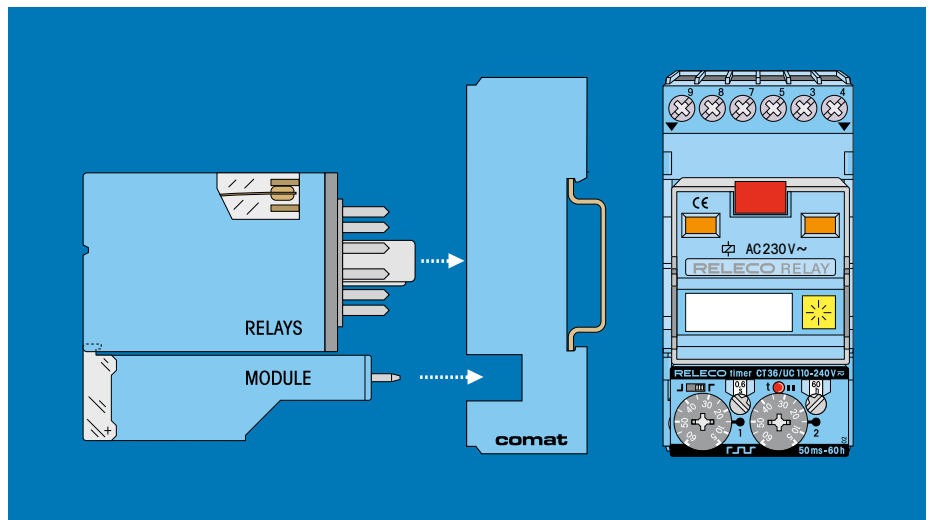
Only 11-pin version shown.
The dimension of the 8-pin version are identical

Technical approvals, conformities



2.2 Time Modules

Modular plug-in Time Relays (CT-System)



The modular timer system consists of individual plug-in timer modules with front cover, an 11-pole plug-in relay and a system socket with retaining spring.

The individual combination allows an optimal device selection for the foreseen application.

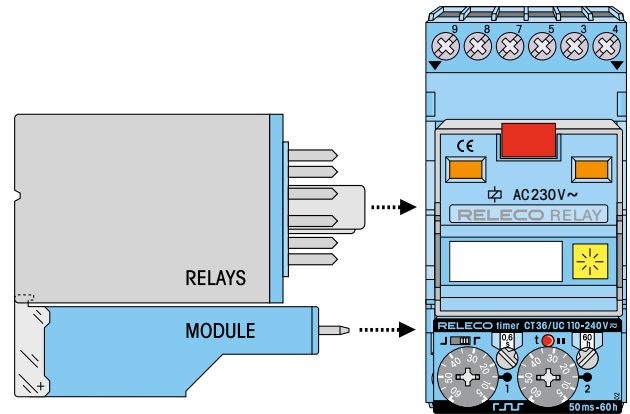
Later modifications as for example an exchange of relay from mechanical contacts to a relay with solid-state outputs are possible at any time. The user profits of a universal system of worldwide unique flexibility.

The modular Comat timer CT System

The time delay relays and monitoring relays consist of plug-in CT electronic modules and 11-pole output relays. Both system components can be combined in a variety of combinations. This allows adapting the system for the specific application.

Subsequent modifications, for example a change from mechanical contacts to solid-state outputs, are possible at any time just by replacing the relay.

This system provides the user a complete universal system with worldwide unmatched flexibility.



The system sockets C12B0 or C-155 serve as a basis for the secure reception of the electronic modules. The sockets have a 4-pole module slot in which the CT modules lock firmly and vibration proof also without the output relay. Contact is made with reliable twin knife contacts.

With the A2 connector bridge "C-A2", the neutral conductor (N/-) can be connected from socket to socket. It reduces wiring work considerably.

Robust terminals for wires up to 4 mm² and spacious labeling are other advantages of this practical Comat modular system.

Clear markings close to the terminal connections on the sockets make it easy to identify the connections for wiring and servicing.

The CT modules are proof of the practical oriented experiences of Comat in the field of industrial electronics. All control and display elements are arranged easy accessible at all times on the front side of the modules. The functions and settings are self-explanatory schematically illustrated on the front and allow to review the set values also during operation.

A transparent cover over the module setting components provides protection from unintentional settings and additionally links the module to the output relay.

Triggering is performed with the operating voltage. (L1 or +). No potential-free contacts are therefore required. The triggering complies to machine standards. Parallel connection to B1 is admissible.

The wide UC voltage range (AC/DC) of the modules give a wide flexibility. It permits the connection to AC or DC supplies and provides a high level of reliability in triggering.

Note: In case of even wider voltage ranges, for example UC 24-240V, triggering currents on B1 are often in the range of 100µA with simultaneous low threshold voltages of less than 20V. Due to capacitive or inductive pickups this may lead to unintentional triggering or switching errors caused by insufficient load on the control contacts (It is not seldom that 50V or more can be measured in open lines).

The output relays show the connection diagram and the technical values on the front side, (exception C3 and C5 relays). A color code indicates an AC coil with red and a DC coil with blue color. Most of the relays have a lockable test button for manual operation.

The standard contacts have proven its reliability for high switching current applications over many years. The contact material AgNi permits a wide switching range and due to the large dimensioning they are designed for a high number of switching cycles. The high breaking capacity of up to 10A/400V and a low load switching capability of 12V/10mA makes the contact suitable for the use in main circuits as well as for low voltage applications.

The twin contacts are switching the load circuit with 2 independent contact tongues. The switching safety for low currents is therefore 100 times higher compared to a single contact relay. Despite the high switching capacity of up to 6A/250V, these contacts are very suitable to switch low currents and voltages up to 1mA/6V.

The solid-state relays are an alternative to mechanical relays. In the standard version, the relay has a potential-free universal semiconductor output for AC or DC loads. The advantage is a bouncing- and wear-free, overload resistant, short circuit protected output with a practical unlimited life cycle.

Solid-state relays are specially recommended for applications of high switching cycles, for example for repeat cycle timers, flushing lights, but also for high inductive switching loads of solenoid valves, couplings, motors, etc. The solid state relays are also suitable for capacitive loads, for example long power lines, or compensated lighting circuits.

Additional protection circuits of the output or of the load are not necessary in any application for this type of Comat relays.

The solid-state relays are insensitive in any aggressive environment such as chemical plants, sewage plants etc. and are therefore an excellent choice for the employment in such environments.



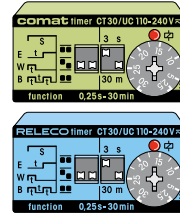
The train symbol indicates products available in a special railway execution according to EN 50155. Please refer to our special railway brochure for details.

CT30, CT32, CT33, CT36

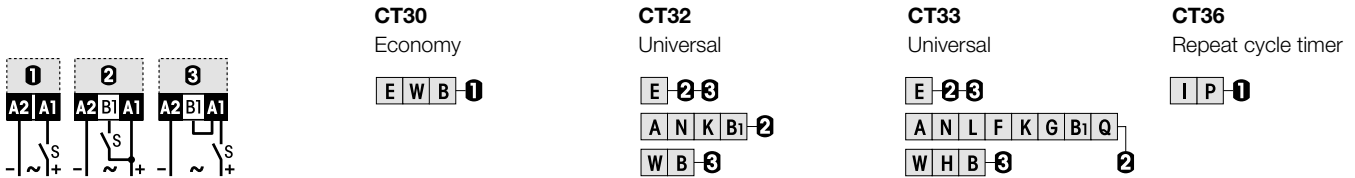
Plug-in time modules (combined with industrial relays)

Type Blue: CT30, CT32, CT33, CT36, /...V R
Green: CT30, CT32, CT33, CT36, /...V

Plug-in time modules for sockets with module slot in combination with plug-in relays.
Power supply and control voltages 24 ... 240 V. Time ranges 30 ms up to 60 h.
LED output state indicator.



Time functions and related connection diagrams (Function diagrams: refer to page 130)



Time data	CT 30	CT 32	CT33	CT36
Type	CT 30	CT 32	CT33	CT36
Partial time ranges, t_{max}	3, 30 /s /min	1.5, 6, 15, 60 /s /min	150, 600 ms	2 x 600 ms
Min. time t_{min}	0.25 s	0.15 s	1.5, 6, 15, 60 /s /min /h	2 x 6, 60 /s /min /h
Fine adj. range $t_{min} \dots t_{max}$	2.5 ... 30	1 ... 10	30 ms	2 x 50 ms
Time range tolerance t_{min}	-25 ... 0 %	-25 ... 0 %	0.2 ... 1	2 x 5 ... 60
t_{max}	0 ... 35 %	0 ... 25 %	-25 ... 0 %	-25 ... 0 %
Repetition accuracy	± 0.2 % or 20 ms	± 0.2 % or 20 ms	0 ... 25 %	0 ... 25 %
Temperature drift of time	0.25 % / K	± 0.1 % / K	± 0.2 % or 20 ms	± 0.2 % or 20 ms
Min. trigger pulse width B1	-	≥ 30 ms	0.1 % / K	0.1 % / K
Reset time pow. supply	≤ 200 ms	≥ 30 ms	-	-
Voltage failure buffering	≥ 20 ms	≤ 150 ms	≤ 30 ms	≤ 150 ms
		≥ 20 ms	≥ 150 ms	≥ 20 ms

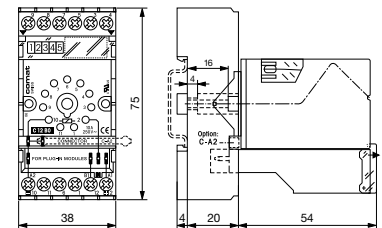
Output data	UC 24 – 48 V	110 – 240, 115, 230 V
Nominal voltage	UC 24 – 48 V	110 – 240, 115, 230 V
Type	Solid state	Solid state
Rated operational current	150 mA	50 mA
On-state resistance	$\leq 25 \Omega$	$\leq 100 \Omega$
Leakage current	$\leq 150 \mu A$	$\leq 150 \mu A$

Power supply and control input (UC = AC / DC)	CT 30	CT 30	CT36	CT36
Type	CT 30	CT 30	CT36	CT36
Nominal voltage	UC 24 – 48 V	UC 110 – 240 V	UC 24 – 48 V	UC 110 – 240 V
Operating voltage range	19 ... 75 V	90 ... 265 V	19...60 V	82 ... 265 V
Supply current	3 ... 5 mA	2 ... 4 mA	6 ... 12 mA	4 ... 8 mA
Type	CT32, CT33	CT32, CT33	CT32, CT33	
Nominal voltage	UC 24 – 48 V	UC 115 V	UC 230 V	
Operating voltage range	19 ... 60 V	90 ... 150 V	180 ... 265 V	
Input B1 inactive	≤ 9 V	≤ 60 V	≤ 100 V	
Supply current	5 ... 11 mA	4 ... 7 mA	1 ... 4 mA	

General Specification	
Ambient temperature storage /operation	-40 ... 85 °C / -40 ... 60 °C
Ingress Protection degree	IP 40 when plugged in
Housing material	Lexan
Weight	25 g

Standard types	Blue	Green
CT30, CT32, CT33, CT36, UC24-48	CT3x/UC24-48V R	CT3x/UC24-48V
CT30, CT36, UC110-240	CT3x/UC110-240V R	CT3x/UC110-240V
CT32, CT33, UC115	CT3x/UC115V R	CT3x/UC115V
CT32, CT33, UC230	CT3x/UC230V R	CT3x/UC230V

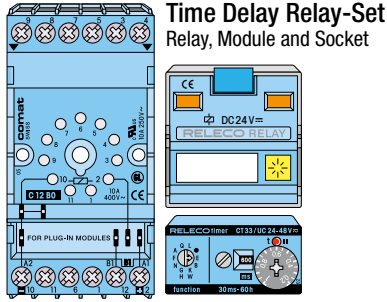
Dimensions [mm]



Technical approvals, conformities

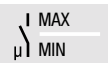


Remark: This module is part of several ready for connection units consisting of socket, relay and module. A wide range of suitable relays are available.

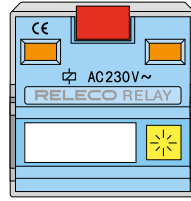
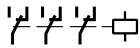


Time Delay Relay-Set
Relay, Module and Socket

Relay data's see:
Section Industrial Relays



Power Relay

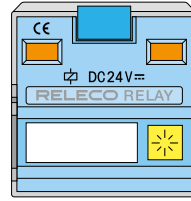
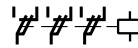


C3-A30X

Universal
Power Relay 10A.
With 3 power changeover-contacts
this is the robust relay for AC and
DC circuits ranging from
10mA 10V.

10A~
10mA 10V

Control Relay

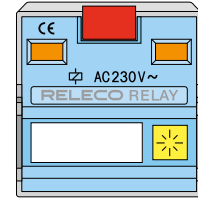
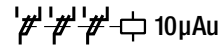


C3-T31X

Relay with 3 twin contacts 6A
The control relay with highest
switching reliability for control
and signal circuits ranging from
5mA 5V.

6A 250V~
5mA 5V

Signal Relay

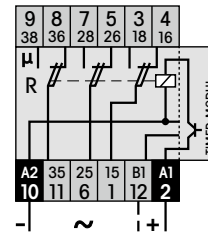
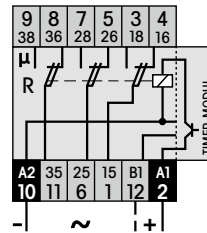
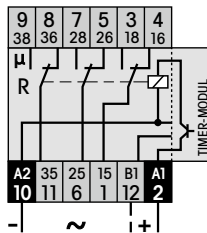
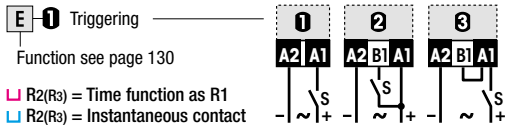


C3-T32X

Relay with 3 twin contacts, 10µ gold flush
The twin contact relay with high-
est switching reliability for signal
circuits ranging from 1mA 5V.
Recommend. upto 0,2A 30V.

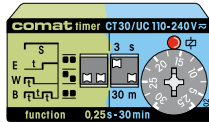
6A 250V~
1mA 5V

Timer-Modul (Function diagrams: refer to page 130)



CT30 Economy timer

3 functions, voltage controlled,
output LED.
Seismic approved.



Function / Triggering



Time range
0,25s - 30min
0,25 - 3s...
2,5-30min

Set Order-Nr.:

CT30.3-A30/...V R
AC 24, 48, 115, 230V
DC 24, 48, 110, 220V

Delivery includes:
• Relay C3-A30X/...V
• Module CT30/...V R
• Front cover FS-R
• Socket C12B0 R
• Retaining clip S3-C

Set Order-Nr.:

CT30.3-T31/...V R
AC 24, 48, 115, 230V
DC 24, 48, 110, 220V

Delivery includes:
• Relay C3-T31X/...V
• Module CT30/...V R
• Front cover FS-R
• Socket C12B0 R
• Retaining clip S3-C

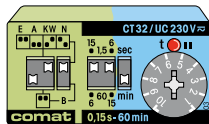
Set Order-Nr.:

CT30.3-T32/...V R
AC 24, 48, 115, 230V
DC 24, 48, 110, 220V

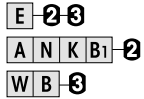
Delivery includes:
• Relay C3-T32X/...V
• Modul CT30/...V R
• Front cover FS-R
• Socket C12B0 R
• Retaining clip S3-C

CT32 Universal timer

7 functions, voltage controlled, time
lapse display, blinking.
Seismic approved.



Function / Triggering



Time range
0,15s - 60min
0,15 - 1,5s...
6-60min

Set Order-Nr.:

CT32.3-A30/...V R
AC 24, 48, 115, 230V
DC 24, 48, 110, 220V

Delivery includes:
• Relay C3-A30X/...V
• Module CT32/...V R
• Front cover FS-R
• Socket C12B0 R
• Retaining clip S3-C

Set Order-Nr.:

CT32.3-T31/...V R
AC 24, 48, 115, 230V
DC 24, 48, 110, 220V

Delivery includes:
• Relay C3-T31X/...V
• Module CT32/...V R
• Front cover FS-R
• Socket C12B0 R
• Retaining clip S3-C

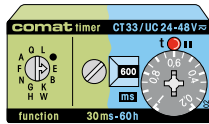
Set Order-Nr.:

CT32.3-T32/...V R
AC 24, 48, 115, 230V
DC 24, 48, 110, 220V

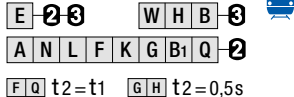
Delivery includes:
• Relay C3-T32X/...V
• Module CT32/...V R
• Front cover FS-R
• Socket C12B0 R
• Retaining clip S3-C

CT33 Universal timer

12 functions, voltage controlled, time
lapse display, blinking, high setting
accuracy by dial graduation 1:5.



Function / Triggering



Time range
30ms - 60h
30 - 150ms...
12 - 60h

Set Order-Nr.:

CT33.3-A30/...V R
AC 24, 48, 115, 230V
DC 24, 48, 110, 220V

Delivery includes:
• Relay C3-A30X/...V
• Module CT33/...V R
• Front cover FS-R
• Socket C12B0 R
• Retaining clip S3-C

Set Order-Nr.:

CT33.3-T31/...V R
AC 24, 48, 115, 230V
DC 24, 48, 110, 220V

Delivery includes:
• Relay C3-T31X/...V
• Module CT33/...V R
• Front cover FS-R
• Socket C12B0 R
• Retaining clip S3-C

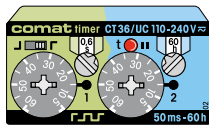
Set Order-Nr.:

CT33.3-T32/...V R
AC 24, 48, 115, 230V
DC 24, 48, 110, 220V

Delivery includes:
• Relay C3-T32X/...V
• Module CT33/...V R
• Front cover FS-R
• Socket C12B0 R
• Retaining clip S3-C

CT36 Repeat cycle timer

Pulse or pause start.
t1/t2 separately settable.
Time lapse display t1/t2.



Function / Triggering



Time range
2x 50ms - 60h
2x 50 - 600ms...
5 - 60h

Set Order-Nr.:

CT36.3-A30/...V R
AC 24, 48, 115, 230V
DC 24, 48, 110, 220V

Delivery includes:
• Relay C3-A30X/...V
• Module CT36/...V R
• Front cover FS-R
• Socket C12B0 R
• Retaining clip S3-C

Set Order-Nr.:

CT36.3-T31/...V R
AC 24, 48, 115, 230V
DC 24, 48, 110, 220V

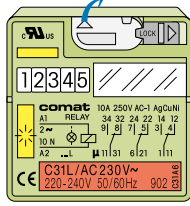
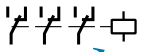
Delivery includes:
• Relay C3-T31X/...V
• Module CT36/...V R
• Front cover FS-R
• Socket C12B0 R
• Retaining clip S3-C

Set Order-Nr.:

CT36.3-T32/...V R
AC 24, 48, 115, 230V
DC 24, 48, 110, 220V

Delivery includes:
• Relay C3-T32X/...V
• Module CT36/...V R
• Front cover FS-R
• Socket C12B0 R
• Retaining clip S3-C

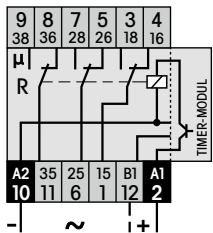
Power Relay



C31L

Universal Power Relay 10A
with 3 power changeover-contacts this is the robust relay for AC and DC circuits ranging from 50mA 10V.

10 A 250V~
50mA 10V



Set Order-Nr.:

CT30.31/...V

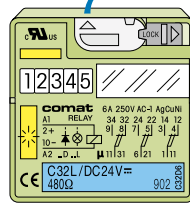
AC 24, 48, 115, 230V

DC 24, 48, 110, 220V

Delivery includes:

- Relay C31L/...V
- Module CT30/...V
- Front cover FS-C
- Socket C12B0
- Retaining clip HF-32

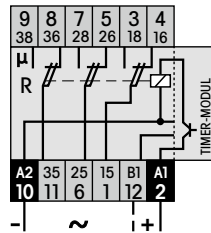
Control Relay



C32L

Relay with 3 twin contacts 6A
The control relay with highest switching reliability for control and signal circuits ranging from 10mA 5V.

6 A 250V~
10mA 5V



Set Order-Nr.:

CT30.32/...V

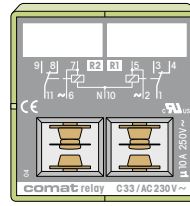
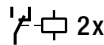
AC 24, 48, 115, 230V

DC 24, 48, 110, 220V

Delivery includes:

- Relay C32L/...V
- Module CT30/...V
- Front cover FS-C
- Socket C12B0
- Retaining clip HF-32

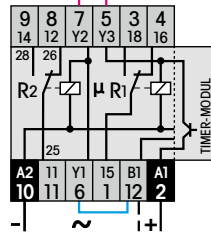
Power Relay



C33

Double-channel Power Relay 10A
With 2x1 power changeover-contacts this is a robust relay for AC and DC circuits ranging from 10mA 12V.

10 A 250V~
10mA 12V



Set Order-Nr.:

CT30.33/...V

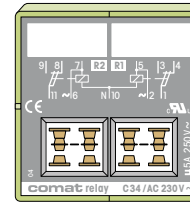
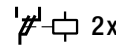
AC 24, 48, 115, 230V

DC 24, 48, 110V

Delivery includes:

- Relay C33/...V
- Module CT30/...V
- Front cover FS-C
- Socket C12B0
- Retaining clip HF-32

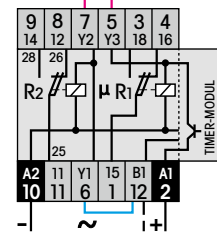
Control Relay



C34

Double-channel Control Relay 5A
With 2x1 changeover-contact. The control relay with increased switching reliability for control and signal circuits from 1mA 6V.

5 A 250V~
1mA 6V



Set Order-Nr.:

CT30.34/...V

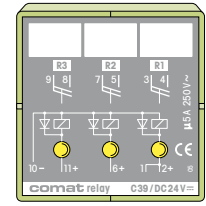
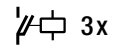
AC 24, 48, 115, 230V

DC 24, 48, 110V

Delivery includes:

- Relay C34/...V
- Module CT30/...V
- Front cover FS-C
- Socket C12B0
- Retaining clip HF-32

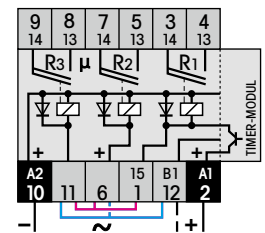
Power- and Signal Relay



C39

Triple-channel Twin Contact Relay 5A
with 3x1 NO contact. Ideal for interface applications ranging from 1mA 100mV. LED display for each channel.

5 A 250V~
1mA 100mV



Set Order-Nr.:

CT30.39/...V

--

DC 24, 48V

Delivery includes:

- Relay C39/...V
- Module CT30/...V
- Front cover FS-C
- Socket C12B0
- Retaining clip HF-32

Set Order-Nr.:

CT32.31/...V

AC 24, 48, 115, 230V

DC 24, 48, 110, 220V

Delivery includes:

- Relay C31L/...V
- Module CT32/...V
- Front cover FS-C
- Socket C12B0
- Retaining clip HF-32

Set Order-Nr.:

CT32.32/...V

AC 24, 48, 115, 230V

DC 24, 48, 110, 220V

Delivery includes:

- Relay C32L/...V
- Module CT32/...V
- Front cover FS-C
- Socket C12B0
- Retaining clip HF-32

Set Order-Nr.:

CT32.33/...V

AC 24, 48, 115, 230V

DC 24, 48, 110V

Delivery includes:

- Relay C33/...V
- Module CT32/...V
- Front cover FS-C
- Socket C12B0
- Retaining clip HF-32

Set Order-Nr.:

CT32.34/...V

AC 24, 48, 115, 230V

DC 24, 48, 110V

Delivery includes:

- Relay C34/...V
- Module CT32/...V
- Front cover FS-C
- Socket C12B0
- Retaining clip HF-32

Set Order-Nr.:

CT32.39/...V

--

DC 24, 48V

Delivery includes:

- Relay C39/...V
- Module CT32/...V
- Front cover FS-C
- Socket C12B0
- Retaining clip HF-32

Set Order-Nr.:

CT33.31/...V

AC 24, 48, 115, 230V

DC 24, 48, 110, 220V

Delivery includes:

- Relay C31L/...V
- Module CT33/...V
- Front cover FS-C
- Socket C12B0
- Retaining clip HF-32

Set Order-Nr.:

CT33.32/...V

AC 24, 48, 115, 230V

DC 24, 48, 110, 220V

Delivery includes:

- Relay C32L/...V
- Module CT33/...V
- Front cover FS-C
- Socket C12B0
- Retaining clip HF-32

Set Order-Nr.:

CT33.33/...V

AC 24, 48, 115, 230V

DC 24, 48, 110V

Delivery includes:

- Relay C33/...V
- Module CT33/...V
- Front cover FS-C
- Socket C12B0
- Retaining clip HF-32

Set Order-Nr.:

CT33.34/...V

AC 24, 48, 115, 230V

DC 24, 48, 110V

Delivery includes:

- Relay C34/...V
- Module CT33/...V
- Front cover FS-C
- Socket C12B0
- Retaining clip HF-32

Set Order-Nr.:

CT33.39/...V

--

DC 24, 48V

Delivery includes:

- Relay C39/...V
- Module CT33/...V
- Front cover FS-C
- Socket C12B0
- Retaining clip HF-32

Set Order-Nr.:

CT36.31/...V

AC 24, 48, 115, 230V

DC 24, 48, 110, 220V

Delivery includes:

- Relay C31L/...V
- Modul CT36/...V
- Front cover FS-C
- Socket C12B0
- Retaining clip HF-32

Set Order-Nr.:

CT36.32/...V

AC 24, 48, 115, 230V

DC 24, 48, 110, 220V

Delivery includes:

- Relay C32L/...V
- Module CT36/...V
- Front cover FS-C
- Socket C12B0
- Retaining clip HF-32

Set Order-Nr.:

CT36.33/...V

AC 24, 48, 115, 230V

DC 24, 48, 110V

Delivery includes:

- Relay C33/...V
- Module CT36/...V
- Front cover FS-C
- Socket C12B0
- Retaining clip HF-32

Set Order-Nr.:

CT36.34/...V

AC 24, 48, 115, 230V

DC 24, 48, 110V

Delivery includes:

- Relay C34/...V
- Module CT36/...V
- Front cover FS-C
- Socket C12B0
- Retaining clip HF-32

Set Order-Nr.:

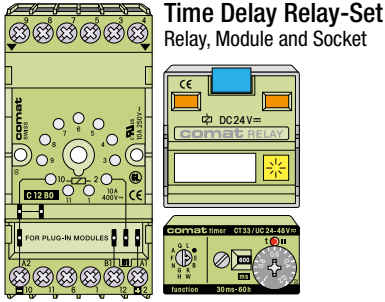
CT36.39/...V

--

DC 24, 48V

Delivery includes:

- Relay C39/...V
- Module CT36/...V
- Front cover FS-C
- Socket C12B0
- Retaining clip HF-32

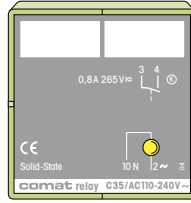


Time Delay Relay-Set
Relay, Module and Socket

Relay data's see:
Section Industrial Relays



UC Solid-State Relay

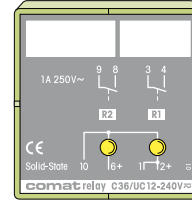


C35

Universal Solid-State Relay for AC or DC load
Highest switching frequency for virtually limitless life cycle due to solid-state operation. No external protective wiring required.

0,8A 10...265V~
1mA 10V

AC Solid-State Relay

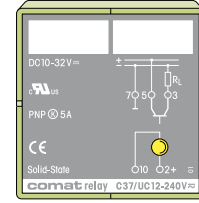


C36

AC SS double-channel
Triac output, crossover switch. Built-in RC wiring protection. Specially designed for frequent switching cycles and inductive loads. Minimum load: 30mA

1A 20...265V~
30mA 20V

DC Solid-State Relay

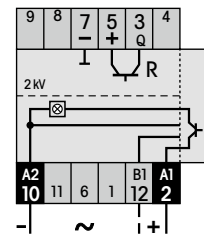
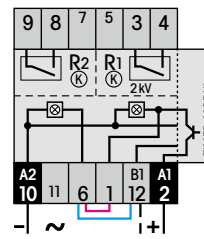
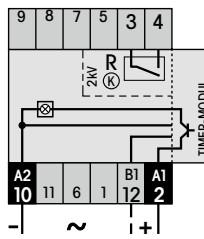
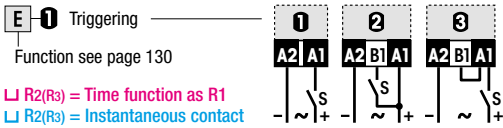


C37

DC SS single-channel
Bounce- and wearing- free for DC loads (inductive/capacitive). Short-circuit/overload proof. No external wiring protection required.

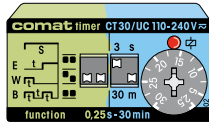
5A 10...32V=
1mA 10V

Timer-Modul (Function diagrams: refer to page 130)



CT30 Economy timer

3 functions, voltage controlled, output LED. Seismic approved.



Function / Triggering



Time range
0,25s - 30min
0,25 - 3s...
2,5 - 30min

Set Order-Nr.:

CT30.35/...V
AC 110-240V
UC 24-48V

Delivery includes:
• Relay C35/...V
• Module CT30/...V
• Front cover FS-C
• Socket C12B0
• Retaining clip HF-32

Set Order-Nr.:

CT30.36/...V
UC 110-240V
UC 24-48V

Delivery includes:
• Relay C36/UC12-240V
• Module CT30/...V
• Front cover FS-C
• Socket C12B0
• Retaining clip HF-32

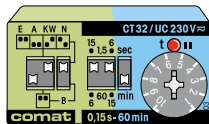
Set Order-Nr.:

CT30.37/...V
UC 110-240V
UC 24-48V

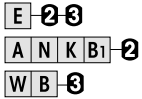
Delivery includes:
• Relay C37/UC12-240V
• Module CT30/...V
• Front cover FS-C
• Socket C12B0
• Retaining clip HF-32

CT32 Universal timer

7 functions, voltage controlled, time lapse display, blinking. Seismic approved.



Function / Triggering



Time range
0,15s - 60min
0,15 - 1,5s...
6 - 60min

Set Order-Nr.:

CT32.35/...V
AC 115, 230V
UC 24-48V

Delivery includes:
• Relay C35/...V
• Module CT32/...V
• Front cover FS-C
• Socket C12B0
• Retaining clip HF-32

Set Order-Nr.:

CT32.36/...V
UC 115, 230V
UC 24-48V

Delivery includes:
• Relay C36/UC12-240V
• Module CT32/...V
• Front cover FS-C
• Socket C12B0
• Retaining clip HF-32

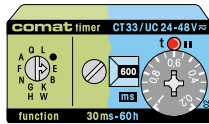
Set Order-Nr.:

CT32.37/...V
UC 115, 230V
UC 24-48V

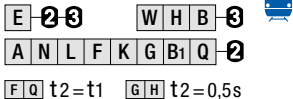
Delivery includes:
• Relay C37/UC12-240V
• Module CT32/...V
• Front cover FS-C
• Socket C12B0
• Retaining clip HF-32

CT33 Universal timer

12 functions, voltage controlled, time lapse display, blinking, high setting accuracy by dial graduation 1:5.



Function / Triggering



Time range
30ms - 60h
30 - 150ms...
12 - 60h

Set Order-Nr.:

CT33.35/...V
AC 115, 230V
DC 24-48V

Delivery includes:
• Relay C35/...V
• Module CT33/...V
• Front cover FS-C
• Socket C12B0
• Retaining clip HF-32

Set Order-Nr.:

CT33.36/...V
UC 115, 230V
UC 24-48V

Delivery includes:
• Relay C36/UC12-240V
• Module CT33/...V
• Front cover FS-C
• Socket C12B0
• Retaining clip HF-32

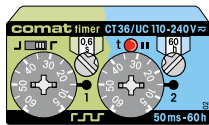
Set Order-Nr.:

CT33.37/...V
UC 115, 230V
UC 24-48V

Delivery includes:
• Relay C37/UC12-240V
• Module CT33/...V
• Front cover FS-C
• Socket C12B0
• Retaining clip HF-32

CT36 Repeat cycle timer

Pulse or pause start. t1/t2 separately settable. Time lapse display t1/t2.



Function / Triggering



Time range
2x 50ms - 60h
2x 50 - 600ms...
5 - 60h

Delivery includes:

CT36.35/...V
AC 110-240V
UC 24-48V

Delivery includes:
• Relay C35/...V
• Module CT36/...V
• Front cover FS-C
• Socket C12B0
• Retaining clip HF-32

Set Order-Nr.:

CT36.36/...V
UC 110-240V
UC 24-48V

Delivery includes:
• Relay C36/UC12-240V
• Module CT36/...V
• Front cover FS-C
• Socket C12B0
• Retaining clip HF-32

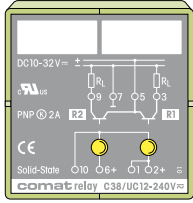
Delivery includes:

CT36.37/...V
UC 110-240V
UC 24-48V

Delivery includes:
• Relay C37/UC12-240V
• Module CT36/...V
• Front cover FS-C
• Socket C12B0
• Retaining clip HF-32

DC Solid-State Relay

2x

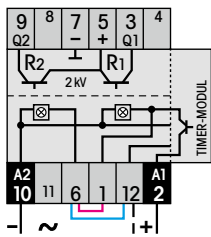


C38

DC SS Relay double-channel
Bounce- and wearing- free for DC loads (inductive/capacitive). Short-circuit/overload proof. No external wiring protection required. 2A constant current per channel.

2A 10...32V=

1mA 10V



Set Order-Nr.:

CT30.38/...V

UC 110-240V

UC 24-48V

Delivery includes:

- Relay C38/UC12-240V
- Module CT30/...V
- Front cover FS-C
- Socket C12B0
- Retaining clip HF-32

Set Order-Nr.:

CT32.38/...V

UC 115, 230V

UC 24-48V

Delivery includes:

- Relay C38/UC12-240V
- Module CT32/...V
- Front cover FS-C
- Socket C12B0
- Retaining clip HF-32

Set Order-Nr.:

CT33.38/...V

UC 115, 230V

UC 24-48V

Delivery includes:

- Relay C38/UC12-240V
- Modul eCT36/...V
- Front cover FS-C
- Socket C12B0
- Retaining clip HF-32

Set Order-Nr.:

CT36.38/...V

UC 110-240V

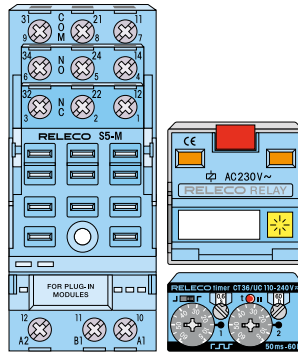
UC 24-48V

Delivery includes:

- Relay C38/UC12-240V
- Modul eCT36/...V
- Front cover FS-C
- Socket C12B0
- Retaining clip HF-32

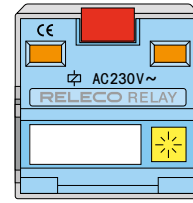


Time Delay Relay-Set Relay, Module and Socket



High Power Relay DC

16A 400V~

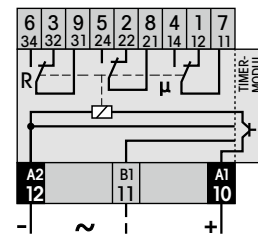


C5-A30X

Universal Power Relay 16A
With 3 power changeover-contacts this is the robust relay for AC and DC circuits ranging from 10mA 10V.

16A 400V~

10mA 10V



Set Order-Nr.:

CT30.5-A30/...V R

AC 24, 115, 230V

DC 24, 110, 220V

Delivery includes:

- Relay C5-A30X/...V
- Module CT30/...V R
- Front cover FS-C5
- Socket S-5M
- Retaining clip S3-C

Set Order-Nr.:

CT32.5-A30/...V R

AC 24, 115, 230V

DC 24, 110, 220V

Delivery includes:

- Relay C5-A30X/...V
- Module CT32/...V R
- Front cover FS-C5
- Socket S-5M
- Retaining clip S3-C

Set Order-Nr.:

CT33.5-A30/...V R

AC 24, 115, 230V

DC 24, 110, 220V

Delivery includes:

- Relay C5-A30X/...V
- Module CT33/...V R
- Front cover FS-C5
- Socket S-5M
- Retaining clip S3-C

Set Order-Nr.:

CT36.5-A30/...V R

AC 24, 115, 230V

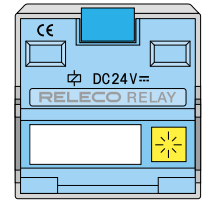
DC 24, 110, 220V

Delivery includes:

- Relay C5-A30X/...V
- Module CT36/...V R
- Front cover FS-C5
- Socket S-5M
- Retaining clip S3-C

High Power Relay DC

10A @ 220V=

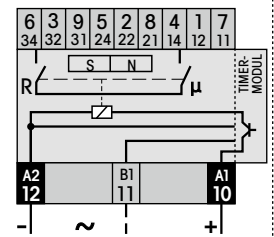


C5-M10X

Highpower Relay, in particular for DC loads upto 10A 220V= (DC1)
With 2 NO contacts in series and a blow magnet for safe arc extinguishing.

16A 400V~

10mA 10V



Set Order-Nr.:

CT30.5-M10/...V R

AC 24, 230V

DC 24, 48, 110, 220V

Delivery includes:

- Relay C5-M10X/...V
- Module CT30/...V R
- Front cover FS-C5
- Socket S-5M
- Retaining clip S3-C

Set Order-Nr.:

CT32.5-M10/...V R

AC 24, 230V

DC 24, 48, 110, 220V

Delivery includes:

- Relay C5-M10X/...V
- Module CT32/...V R
- Front cover FS-C5
- Socket S-5M
- Retaining clip S3-C

Set Order-Nr.:

CT33.5-M10/...V R

AC 24, 230V

DC 24, 48, 110, 220V

Delivery includes:

- Relay C5-M10X/...V
- Module CT33/...V R
- Front cover FS-C5
- Socket S-5M
- Retaining clip S3-C

Set Order-Nr.:

CT36.5-M10/...V R

AC 24, 230V

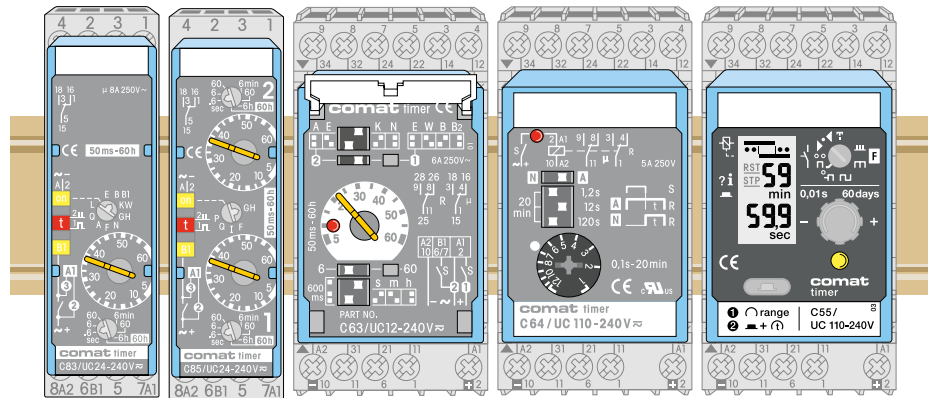
DC 24, 48, 110, 220V

Delivery includes:

- Relay C5-M10X/...V
- Modul CT36/...V R
- Front cover FS-C5
- Socket S-5M
- Retaining clip S3-C

2.3 Plug-in Time Relays

Plug-in Time Relays



Time Relays 2.3

Application	Types	Functions*	Min. time	Max. time	contact rating	Socket
12 Time functions, ON switch service function	C83	E, W, H, B, A, N L, F, K, B1, G, Q	50 ms	60 h	8 A / 250 V	S7-C
Running time without auxiliary voltage, 1xNO & 1x NC contacts	C84	A, N	0.1 s	20 min.	5 A / 250 V	S7-C
Double and repeat cycle timer	C85	I, P, F, Q, G, H	2 x 50 ms	2 x 60 h	8 A / 250 V	S7-C
Multi function timer with 2 CO contacts	C63	E, W, B, B2, A, K, N	50 ms	60 h	6 A / 250 V	S3-xx
Running time without auxiliary voltage, 2 CO contacts	C64	A, N	0.1 s	20 min	5 A / 250 V	S3-xx
Multifunction timer with 15 functions and digital display, including pulse sequence monitoring	C55	E, W, H, B, I, P, A K, N, M, G, F, Q, U, V	0.01 s	60 day	5 A / 250 V	S3-xx
Multifunction timer with digital display, 15 functions including pulse sequence monitoring, solide state output	C55.x	E, W, H, B,I , P, A K, N, M, G, F, Q, U, V	0.01 s	60 day	5 A / 250 V	S3-xx
Multifunction timer with digital display, 15 functions including pulse sequence monitoring, potential free triggering, 2 CO contacts	C56	E, W, H, B, I, P, A K, N, M, G, F, Q, U, V	0.01 s	60 day	5 A / 250 V	S3-xx
Economy time and blinking relay	CS1	E, W, B, B2	50 ms	60 min	8 A / 250 V	S3-xx
Economy time and blinking relay with external potentiometer option	CS2	E, W, B, B2, A, K, N	50 ms	60 h	8 A / 250 V	S3-xx
Universal timer with 2 CO contacts	CS3	E, W, B, B2, A, K, N	50 ms	60 h	6 A / 250 V	S3-xx

* (Function diagrams: refer to page 130)

Multifunction time relay with mechanical change over output contact
12 time functions + test function "ON", 50 ms ... 60 h

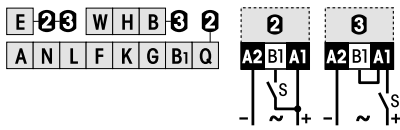
Type: C83/UC24-240V R

Plug-in multifunction time relay, 1 change over power contact, 12 time functions, time ranges: 50 ms ... 60 h, 3 LED's for full state indication: Control input, time run and output, **Seismic qualification** available (precondition for use in nuclear power plants)

Maximum contact load	8 A / 250 V AC-1 240 W DC-1
Recommended minimum contact load	10 mA / 10 V

Time functions and related connection diagrams (Function diagrams: refer to page 130)

The functions are selectable by rotary switch



LED function table:

Function circuit	State	LED function
Output, yellow LED	active	continuous ON
	passive	OFF
Time run, red LED	active	t1: Double blinking t2: Blinking
	passive	OFF
B1 input, yellow LED	active	continuous ON
	passive	OFF

Time data

7 partial time ranges, t_{max} (rotary switch)	0.6, 6, 60 s / 6, 60 min / 6, 60 h
Fine adjustment range (rotary knob)	$t_{min} \dots t_{max}, 0.5 \dots 6$
Time range tolerance	$t_{min}: -30 \% \dots +0 \% / t_{max}: -0 \% \dots +25 \%$
Repetition accuracy	$\pm 0.1 \%$ or DC: 5 ms / AC: 25 ms
Response time, power on, on A1	≤ 40 ms
Min. trigger pulse on B1	30 ms
Reset time B1 (AC/DC)	≤ 50 ms
Voltage failure buffering	≥ 15 ms

Contacts

Type	1CO, Single contact micro disconnection
Material	AgNi
Rated operational current	8 A
Max. inrush current (10 ms)	30 A
Max. switching voltage AC-1	250 V
Max. AC load AC-1 (Fig.1)	2000 VA
Max. DC load DC-1, 30 V / 250 V (Fig.2)	240 W / 75 W

Power supply and control input (UC = AC / DC)

Nominal voltage (A1, B1)	UC 24 – 240 V
Operating voltage range [V]	20 ... 265, 60 Hz: ... 200 V
Power consumption [W]	≤ 1.8
Frequency range [Hz]	45 ... 63
Allowed residual current into B1 [mA]	AC: ≤ 0.8 ; DC: ≤ 1
Trigger threshold voltage on B1, AC / DC [V]	$V_{threshold} = V_{supp} \times m + b; m = 0,35; b = 7,5$

Insulation

Test voltage open contact	1 kVrms 1 minute
Test voltage between contacts and control input	2 kVrms 1 minute

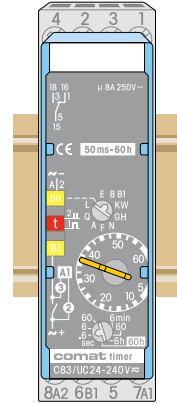
General Specifications

Ambient temperature storage /operation	-40 ... 85 °C / -25 ...60 °C
Mechanical life of contact	30 x 10 ⁶ operations
Expected life @ 25 °C (except contact)	>> 50 000 h
Ingress protection degree	IP 40 when plugged in
Housing material / Weight	Lexan / approx. 60 g

Standard types

UC (AC/DC) 45...63 Hz	C83/UC24-240V R
Seismic qualification:	C83.C2292/UC24-240V R

Accessories: Socket: **S7-C**



Connection diagram

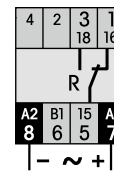


Fig.1 AC electrical endurance

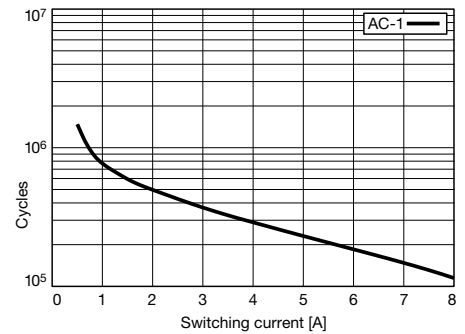
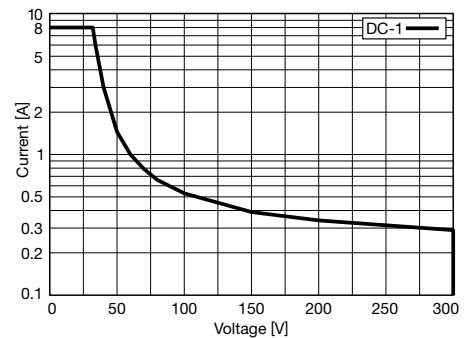
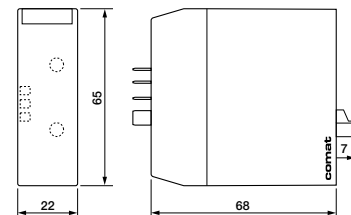


Fig. 2 DC load limit curve



Dimensions [mm]



Technical approvals, conformities

Available:
Seismic IEEE 323, IEEE 344

EN 60947



C84

Time relay, running time without auxiliary voltage, with mechanical NO, NC output contacts, 2 time functions, 0,1 s ... 20 min

Type: C84/... V R

Plug-in time relay

1 normally open + 1 normally closed contact, 250 V

UC 24 V, UC 110 ... 240 V operation voltages

2 time functions, time ranges: 0.1 s ... 20 minutes

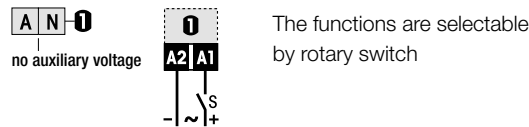
LED for supply voltage state indication

Seismic qualification available (precondition for use in nuclear power plants)

Maximum contact load 5 A / 250 V AC-1 5 A / 30 V DC-1

Recommended minimum contact load 1 mA / 0.1 V

Time functions and related connection diagram (Function diagrams: refer to page 130)



Time data

4 partial time ranges, t_{max} (rotary switch)	1.2 s / 12 s / 120 s / 20 minutes
Fine adjustment range (rotary knob)	$t_{min} \dots t_{max}$, 1 ... 12
Time range tolerance	t_{min} : -25 % ... +5 % / t_{max} : -5 % ... +25 %
Repetition accuracy	± 1 %
Min. start impulse on A1	≥ 150 ms
Reset time	≥ 100 ms
Voltage failure buffering	5 ... 10 ms

Contacts

Type	1 NO, 1 NC, micro disconnection
Material	Gold flash over silver alloy
Rated operational current	5 A
Max. switching voltage AC-1	250 V
Max. switching voltage DC-1	125 V
Max. AC load (Fig.1) AC-1	1250 VA
Max. DC load 30 V / 125 V (Fig.2)	150 W / 25 W

Control input (UC = AC / DC)

	UC 24 ... 48 V	UC 110 ... 240 V
Nominal voltage (A1)	20 ... 60	88 ... 265
Operating voltage range [V]	20 ... 60	88 ... 265
Input current [mA]	3 ... 10	1 ... 5
Inrush current (100 ms) [mA]	200	100
Frequency range [Hz]	45 ... 63	45 ... 63
Threshold voltage AC / DC [V]	≥ 12 / ≥ 16	≥ 55 / ≥ 75

Insulation

Test voltage open contact	1 kVrms 1 minute
Test voltage between poles	2 kVrms 1 minute
Test voltage between contacts and control input	2.5 kVrms 1 minute

General Specifications

Ambient temperature storage /operation	-40 ... 85 °C / -25 ...60 °C
Mechanical life of contacts	≥ 50 x 10 ⁶ operations
Ingress protection degree	IP 40 when plugged in
Housing material / Weight	Lexan / 50 g

Standard types

UC (AC/DC) 45...63 Hz, 24-48, 110-240

Seismic qualification:

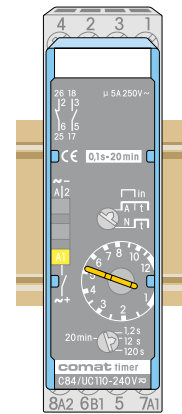
C84/UC...V R

C84.C2292/...V R

" ..." enter the voltage for full type designation

Accessories

Socket: **S7-C**



Connection diagram

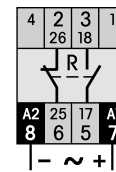


Fig.1 Contact endurance

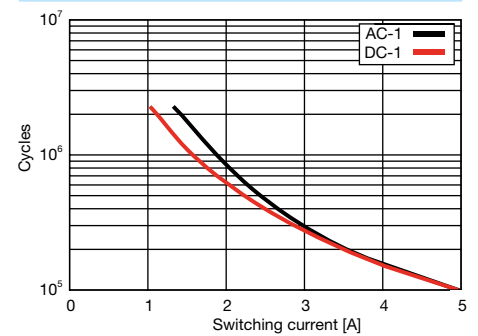
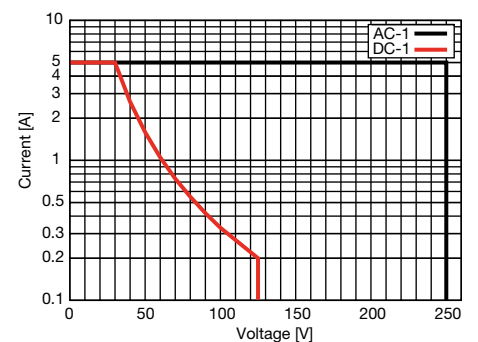
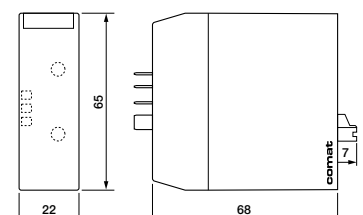


Fig. 2 Load limit curve



Dimensions [mm]



Technical approvals, conformities

Available:
Seismic IEEE 323, IEEE 344

EN 60947



Time relay and repeat cycle timer with 2 time lapses 50 ms ... 60 h, mechanical change over output contact, 6 time functions + test function "ON"

Type: C85/UC24-240 V R

Plug-in multifunction time relay / repeat cycle timer, 1 change over power contact, 6 time functions, time ranges: 2 x 50 ms ... 60 h, 3 LED's for full state indication: Control input, time run and output, **Seismic qualification** available (precondition for use in nuclear power plants)

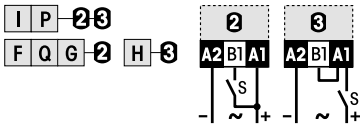
Maximum contact load	8 A / 250 V AC-1 240 W DC-1
Recommended minimum contact load	10 mA / 10 V

Time functions and related connection diagrams (Function diagrams: refer to page 130)

The functions are selectable by rotary switch

LED function table:

Function circuit	State	LED function
Output, yellow LED	active	continuous ON
	passive	OFF
Time run, red LED	active	t1: Double blinking t2: Blinking
	passive	OFF
B1 input, yellow LED	active	continuous ON
	passive	OFF



Time data for each time t1 / t2

7 partial time ranges t_{max} (rotary switch)	0.6, 6, 60 s / 6, 60 min / 6, 60 h
Fine adjustment range (rotary knob)	$t_{min} \dots t_{max}, 0.5 \dots 6$
Time range tolerance	$t_{min}: -30 \% \dots +0 \% / t_{max}: -0 \% \dots +25 \%$
Repetition accuracy	$\pm 0.1 \%$ or DC: 5 ms / AC: 25 ms
Response time, power on, on A1	≤ 40 ms
Min. trigger pulse on B1	30 ms
Reset time B1 (AC/DC)	≤ 50 ms
Voltage failure buffering	≥ 15 ms

Contacts

Type	1CO, Single contact micro disconnection
Material	AgNi
Rated operational current	8 A
Max. inrush current (10 ms)	30 A
Max. switching voltage AC-1	250 V
Max. AC load AC-1 (Fig.1)	2000 VA
Max. DC load DC-1 30 V / 250 V (Fig.2)	240 W / 75 W

Power supply and control input (UC = AC / DC)

Nominal voltage (A1, B1)	UC 24 – 240 V
Operating voltage range [V]	20 ... 265, 60 Hz: ... 200 V
Power consumption [W]	≤ 1.8
Frequency range [Hz]	45 ... 63
Allowed residual current into B1 [mA]	AC: ≤ 0.8 ; DC: ≤ 1
Trigger threshold voltage on B1, AC / DC [V]	$V_{th} = V_{supp} \times m + b$; $m = 0,35$; $b = 7,5$ V

Insulation

Test voltage open contact	1 kVrms 1 minute
Test voltage between contacts and control input	2 kVrms 1 minute

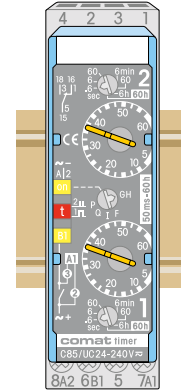
General Specifications

Ambient temperature storage /operation	-40 ... 85 °C / -25 ... 60 °C
Mechanical life of contact	30×10^6 operations
Expected life @ 25 °C (except contact)	$\gg 50\,000$ h
Ingress protection degree	IP 40 when plugged in
Housing material / Weight	Lexan / approx. 60 g

Standard types

UC (AC/DC) 45...63 Hz	C85/UC24-240V R
Seismic qualification:	C85.C2292/UC24-240V R

Accessories: Socket: **S7-C**



Connection diagram

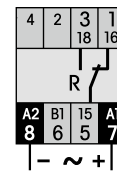


Fig.1 AC electrical endurance

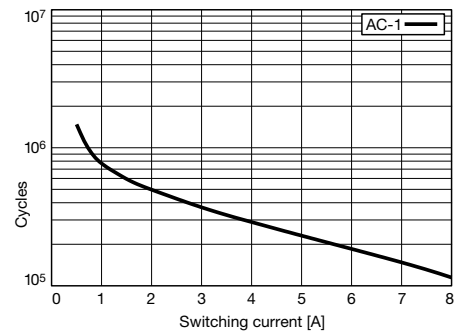
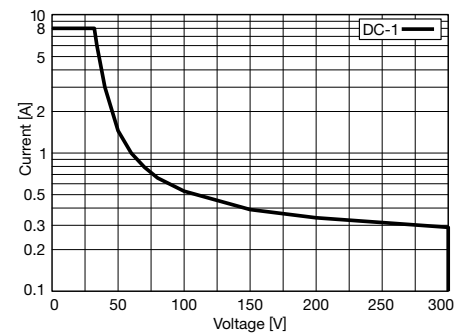
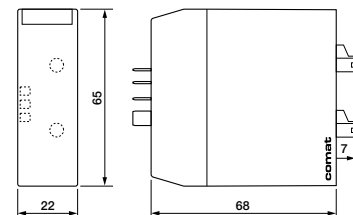


Fig. 2 DC load limit curve



Dimensions [mm]



Technical approvals, conformities

Available:
Seismic IEEE 323, IEEE 344

EN 60947



C63

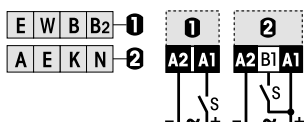
11 pin plug-in time relay according to IEC 67-I-18a, 50 ms ... 60 h, wide band 12 ... 240 V operating voltage, 2 change over output contacts

Type: C63/UC 12-240V R

Plug-in time relay
 2 change over contacts
 UC 12-240 V operating voltage
 7 time functions, time ranges: 50 ms ... 60 h
 LED for output state indication

Maximum contact load 6 A / 250 V AC-1
Recommended minimum contact load 10 mA / 10 V

Time functions and related connection diagrams (Function diagrams: refer to page 130)



Time data

7 partial time ranges, t_{max} (DIP switch) 0.6, 6, 60 s / 6, 60 min / 6, 60 h
 Fine adjustment range (rotary knob) $t_{min} \dots t_{max}$, 5 ... 60
 Time range tolerance t_{min} : -5 % ... +0 % / t_{max} : -0 % ... +5 %
 Repetition accuracy $\pm 1 \%$
 Min. trigger impulse on B1 ≥ 30 ms
 Reset time ≤ 30 ms
 Voltage failure buffering 20 ms

Contacts

Type 2 CO, micro disconnection
 Material AgNi
 Rated operational current 6 A
 Max. switching voltage AC-1 250 V
 Max. AC load AC-1 (Fig.1) 1500 VA
 Max. DC load DC-1 30 V / 250 V (Fig.2) 180 W / 60 W

Power supply- and control input (UC = AC / DC)

Nominal voltage (A1, B1) **UC 12 ... 240 V**
 Operating voltage range 10.2 ... 265 V
 Power consumption ≤ 1.4 W
 Frequency range 45 ... 63 Hz
 Allowed residual current into B1 AC / DC ≤ 2.3 mA / 1.2 mA
 Trigger threshold voltage on B1, AC / DC 6.5 V / 7 V

Insulation

Test voltage open contact 1 kVrms 1 minute
 Test voltage between poles 2 kVrms 1 minute
 Test voltage between contacts and control input 2 kVrms 1 minute

General Specifications

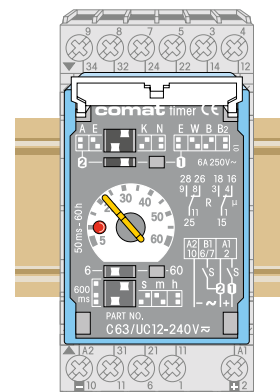
Ambient temperature storage /operation -40 ... 85 °C / -25 ... 60 °C
 Mechanical life of contacts $\geq 30 \times 10^6$ operations
 Ingress protection degree IP 40 when plugged in
 Housing material / Weight Lexan / 75 g

Standard types

UC (AC/DC) **C63/UC12-240V R**

Accessories

Socket: **S3-xx**
 Retaining clip **HF-50**
 Transparent front cover **FA-50**
 Front panel mounting set **FZ-50L** (Frame + retaining clip + socket with soldering connections)



Connection diagram

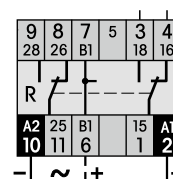


Fig.1 AC electrical endurance

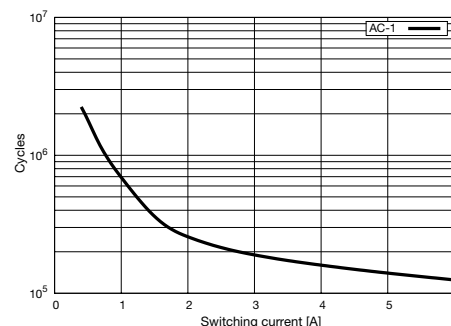
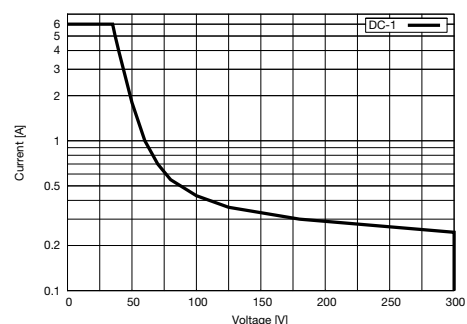
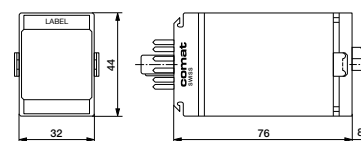


Fig. 2 DC load limit curve



Dimensions [mm]



Technical approvals, conformities

EN 60947



C64

11 pin plug-in time relay according to IEC 67-1-18a, running time without supply voltage, 2 time functions, 2 CO output contacts

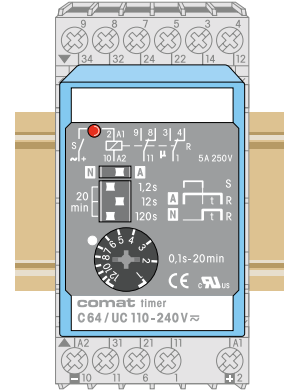
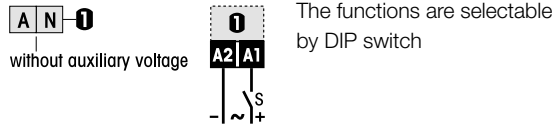


Type: C64/... V R

Plug-in time relay, 2 change over contacts, UC 24 V, UC 110 ... 240 V operating voltages, 2 time functions, time ranges: 0.1 s ... 20 minutes, LED for supply voltage state indication, **Seismic qualification** available (precondition for use in nuclear power plants)

Maximum contact load	5 A / 250 V AC-1 5 A / 30 V DC-1
Recommended minimum contact load	1 mA / 0.1 V

Time functions and related connection diagram (Function diagrams: refer to page 130)



Time data

4 partial time ranges, t_{max} (DIP switch)	1.2 s / 12 s / 120 s / 20 minutes
Fine adjustment range (rotary knob)	$t_{min} \dots t_{max}$, 1 ... 12
Time range tolerance	t_{min} : -25 % ... +5 % / t_{max} : -5 % ... +25 %
Repetition accuracy	± 1 %
Min. start impulse on A1	≥ 150 ms
Reset time	≥ 100 ms
Voltage failure buffering	5 ... 10 ms

Contacts

Type	2 CO, micro disconnection
Material	Gold flash over silver alloy
Rated operational current	5 A
Max. switching voltage AC-1	250 V
Max. switching voltage DC-1	125 V
Max. load AC-1 (Fig.1)	1250 VA
Max. DC load DC-1 30 V / 125 V (Fig.2)	150 W / 25 W

Control input (UC = AC / DC)

	UC 24 ... 48 V	UC 110 ... 240 V
Nominal voltage (A1)	20 ... 75	88 ... 265
Operating voltage range [V]	20 ... 75	88 ... 265
Input current [mA]	3 ... 15	1 ... 5
Inrush current (100 ms) [mA]	200	100
Frequency range [Hz]	48 ... 400	45 ... 400
Threshold voltage AC / DC [V]	≥ 12 / ≥ 16	≥ 55 / ≥ 75

Insulation

Test voltage open contact	1 kVrms 1 minute
Test voltage between poles	2 kVrms 1 minute
Test voltage between contacts and control input	2 kVrms 1 minute

General Specifications

Ambient temperature storage / operation	-40 ... 70 °C / -25 ... 60 °C
Mechanical life of contacts	≥ 50 x 10 ⁶ operations
Ingress protection degree	IP 40 when plugged in
Housing material / Weight	Lexan / 75 g

Standard types

UC (AC/DC) 48...400 Hz, 24-48, 110-240

C64/UC...V R
C64.C2292/...V R

Seismic qualification:

"..." enter the voltage for full type designation

Accessories:

Socket:	S3-xx
Retaining clip	HF-50
Transparent front cover	FA-50
Front panel mounting set	FZ-50L (Frame + retaining clip + socket with soldering connections)

Connection diagram

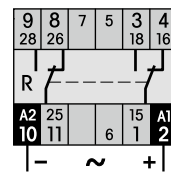


Fig.1 Contact endurance

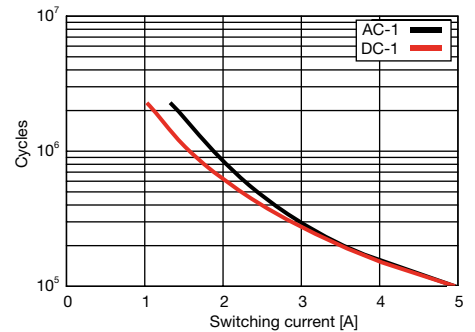
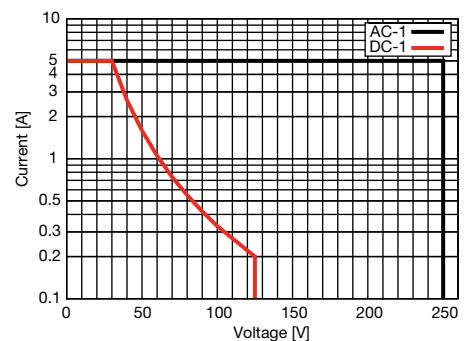
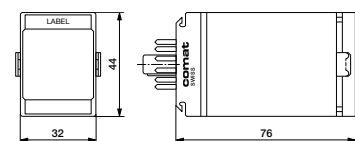


Fig. 2 Load limit curve



Dimensions [mm]



Technical approvals, conformities

Available:
Seismic IEEE 323, IEEE 344

EN 60947



C55

11 pin plug-in time relay according to IEC 67-I-18a, 2 change over contacts
Digital quartz time relay with 15 time functions including pulse
sequence monitoring. Time- Stop and Reset inputs. 10 ms ... 60 days.

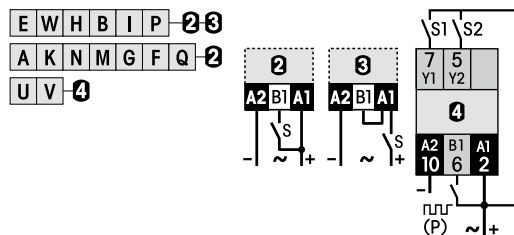


Type: C55/... V R

Plug-in digital time relay, 2 change over contacts, UC 24 ... 60 V, UC 110 ... 240 V operating voltages, 15 time functions including rotational speed monitoring or similar applications, time- STOP and RESET function inputs, Time run / function state display and interactive time setting by display, Digital setting of time until 60 days, quartz precision

Maximum contact load 5 A / 250 V AC-1 5 A / 35 V DC-1
Recommended minimum contact load 10 mA / 12 V

Time functions and related connection diagrams (Function diagrams: refer to page 130)



Stop input (static):

Stops time run

Reset input (dynamic):

Sets timer to start condition, time runs again from beginning

Time data

Time ranges seconds	0.01 s ... 59.9 s	resolution 0.01s
Time ranges minutes	0.1 s ... 59 min 59.9 s	resolution 0.1 s
Time ranges hours	0.1 min ... 59 h 59.9 min	resolution 0.1 min
Time ranges days	0.1 h ... 59 day 23.9 h	resolution 0.1 h
Time accuracy, % from set value	0.05%	
Repetition accuracy	0.05% or ±10 ms	
Min. trigger pulse on B1 AC / DC	40 ms / 30 ms	
Reset time on A1	≤ 200 ms	

Contacts

Type	2 CO, micro disconnection
Material	AgNi
Rated operational current	5 A
Max. switching voltage AC-1	250 V
Max. AC load AC-1 (Fig.1)	1250 VA
Max. DC load DC-1, 30 V / 250 V (Fig.2)	150 W / 60 W

Power supply- and control inputs (Start, Stop, Reset) (UC = AC / DC)

	UC 24...60 V	UC 110...240 V
Nominal voltage	19 ... 75	88 ... 265
Operating voltage range [V]	19 ... 75	88 ... 265
Power consumption [W]	≤ 2	≤ 2
Frequency range [Hz]	48 ... 400	48 ... 400
Allowed residual current AC / DC [mA]	≤ 1.5	≤ 1
Threshold voltage control inputs [V]	≥ 11	≥ 50

Insulation

Test voltage between contacts and other connections: 2 kVrms 1 minute

General Specifications

Ambient temperature storage /operation	-40 ... 85 °C / -25 ... 60 °C
Mechanical life of contacts	≥ 30 x 10 ⁶ operations
Expected life @ 40 °C (MTBF) (except contacts)	> 150 000 h
Ingress protection degree	IP 40 when plugged in
Housing material / Weight	Lexan / 80 g

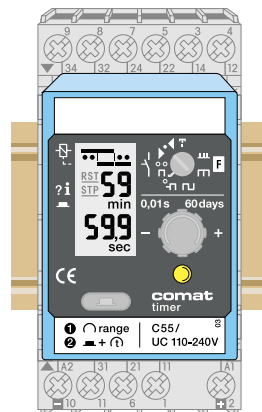
Standard types

UC (AC/DC) 48...400 Hz
UC (AC/DC) 48...400 Hz

C55/UC24-60V R
C55/UC110-240V R

Accessories:

Socket:	S3-xx
Retaining clip	HF-50
Transparent front cover	FA-50
Front panel mounting set	FZ-50L (Frame + retaining clip + socket with soldering connections)



Connection diagram

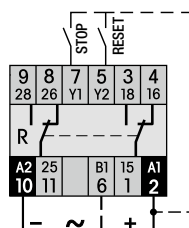


Fig.1 AC electrical endurance

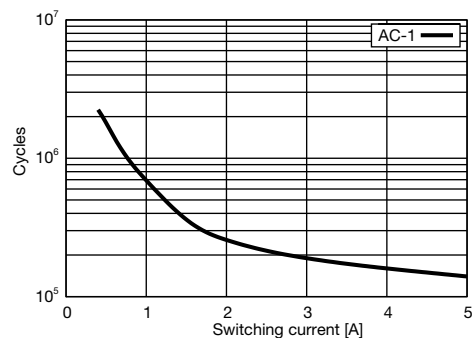
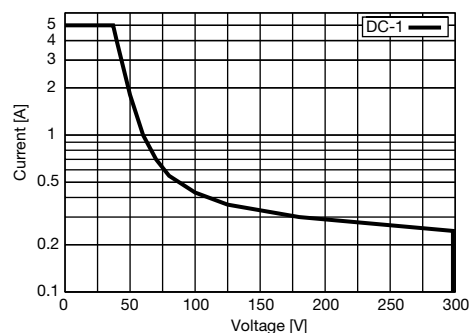
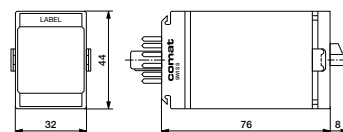


Fig. 2 DC load limit curve



Dimensions [mm]



Technical approvals, conformities

EN 60947



C55.3; C55.4

Solid state outputs 11 pin plug-in time relay according to IEC 67-I-18a.

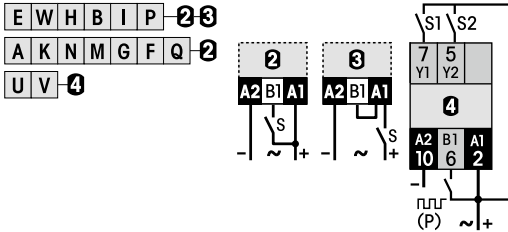


Type: C55.3/... V R, C55.4/DC24V R

Plug-in digital time relay, 2 types of solid state outputs: DC 24 V, UC 10...265 V, DC 24 V, UC 24 ... 60 V, UC 110 ... 240 V operating voltages, 15 time functions including rotational speed monitoring or similar applications, time- STOP and RESET function inputs, Time run / function state display and interactive time setting by display, Digital setting of time until 60 days, quartz precision

Maximum output load xxx.3: 0.5 A / 265 V AC / DC; xxx.4: 2 A / 30 V DC

Time functions and related connection diagrams (Function diagrams: refer to page 130)

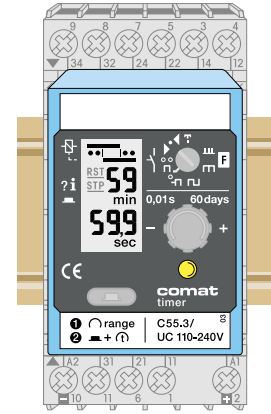


Stop input Y1, pin 7 (static):

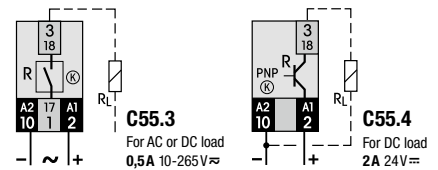
Stops time run while active

Reset input Y2, pin 5 (dynamic):

Sets timer to start condition, time runs again from beginning



Connection diagram



Time data

Time ranges seconds	0.01 s ... 59.9 s	resolution 0.01 s
Time ranges minutes	0.1 s ... 59 min 59.9 s	resolution 0.1 s
Time ranges hours	0.1 min ... 59 h 59.9 min	resolution 0.1 min
Time ranges days	0.1 h ... 59 day 23.9 h	resolution 0.1 h
Time accuracy, % from set value	0.05 %	
Repetition accuracy	0.05 % or ±10 ms	
Min. trigger pulse on B1 AC/DC	40 ms / 30 ms	
Reset time on A1 (AC/DC)	≤ 200 ms	

Outputs

	C55.3	C55.4
Type	UC (AC / DC) solid state insulated to inputs	DC solid state A2 common connection
Overload and short circuit proof	Yes (6 A / 2 μs) "sc" displ.	Yes (40 A / 150 μs)
Max. switching voltage	265 V	30 V
Rated operational current	0.5 A	2 A
Max. inrush current	3 A (10 ms) Fig.1	20 A (not for continuous repetitive operation)
Max. inductive switch-off energy	0.5 Ws @ 2 s cycle time	1 Ws single pulse

Power supply- and control inputs (Start, Stop, Reset) (UC = AC / DC)

	DC 24 V	UC 24...60 V	UC 110...240 V
Nominal voltage	19 ... 30	19 ... 75	88 ... 265
Operating voltage range [V]	≤ 1	≤ 2	≤ 2
Power consumption [W]	-	48 ... 400	48 ... 400
Frequency range [Hz]	≤ 1	≤ 1.5	≤ 1
Allowed residual current AC / DC [mA]	≥ 7	≥ 11	≥ 50
Threshold voltage, control inputs [V]			

Insulation

	C55.3	C55.4
Test voltage between outputs and other connections	2 kVrms 1 minute	not insulated

General specifications

Ambient temperature storage /operation	-40 ... 85 °C / -25 ...60 °C
Expected life @ 40 °C (MTBF)	> 150 000 h
Ingress protection degree	IP 40 when plugged in
Housing material / Weight	Lexan / 80 g

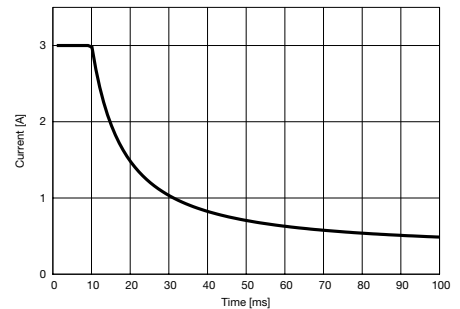
Standard types

UC (AC/DC) 48...400 Hz	C55.3/UC24-60V R C55.3/UC110-240V R
DC 24 V	C55.4/DC24V R

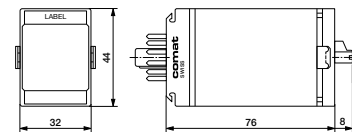
Accessories: Socket:

Retaining clip	S3-xx
Transparent front cover	HF-50
Spare label plate	FA-50
Front panel mounting set	PL-50
	FZ-50L (Frame + retaining clip + socket with soldering connections)

Fig.1 Inrush current



Dimensions [mm]



Technical approvals, conformities

EN 60947



C56

11 pin plug-in time relay according to IEC 67-I-18a, 2 change over contacts. Potential-free triggering of Start- Stop- and Reset inputs.

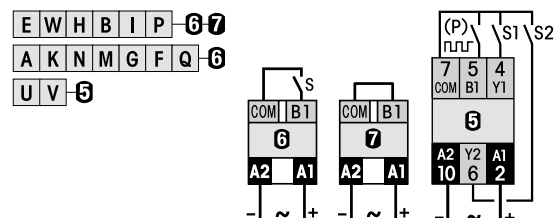


Type: C56/... V R

Plug-in digital time relay, 2 change over contacts, UC 24 ... 60 V, UC 110 ... 240 V operating voltages, 15 time functions including rotational speed monitoring or similar applications, time- STOP and RESET function inputs, Time run / function state display and interactive time setting by display, Digital setting of time until 60 days, quartz precision

Maximum contact load	5 A / 250 V AC-1	5 A / 35 V DC-1
Recommended minimum contact load	10 mA / 12 V	

Time functions and related connection diagrams (Function diagrams: refer to page 130)



Stop input (static):
Stops time run

Reset input (dynamic):
Sets timer to start condition, time runs again from beginning

Time data

Time ranges seconds	0.01 s ... 59.9 s	resolution 0.01s
Time ranges minutes	0.1 s ... 59 min 59.9 s	resolution 0.1 s
Time ranges hours	0.1 min ... 59 h 59.9 min	resolution 0.1 min
Time ranges days	0.1 h ... 59 day 23.9 h	resolution 0.1 h
Time accuracy, % from set value	0.05%	
Repetition accuracy	0.05% or ±10 ms	
Min. trigger pulse on B1	30 ms	
Reset time on A1	≤ 200 ms	

Contacts

Type	2 CO, micro disconnection
Material	AgNi
Rated operational current	5 A
Max. switching voltage AC-1	250 V
Max. AC load AC-1 (Fig.1)	1250 VA
Max. DC load DC-1, 30 V / 250 V (Fig.2)	150 W / 60 W

Power supply data (UC = AC / DC)

	UC 24...60 V	UC 110...240 V
Nominal voltage	19 ... 75	88 ... 265
Operating voltage range [V]	≤ 2	≤ 2
Power consumption [W]	48 ... 400	48 ... 400

Control inputs

Working voltage	10 V
Input current	≤ 4 mA
Max. transient voltage	1 kV, 50 μs

Insulation

Test voltage between contacts and other connections: 2 kVrms 1 minute

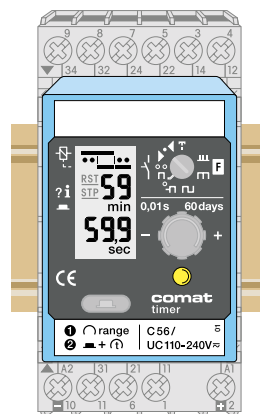
General Specifications

Ambient temperature storage /operation	-40 ... 85 °C / -25 ... 60 °C
Mechanical life of contacts	≥ 30 x 10 ⁶ operations
Expected life @ 40 °C (MTBF) (except contacts)	> 150 000 h
Ingress protection degree	IP 40 when plugged in
Housing material / Weight	Lexan / 80 g

Standard types

UC (AC/DC) 48...400 Hz	C56/UC24-60V R
UC (AC/DC) 48...400 Hz	C56/UC110-240V R

Accessories: Socket:	S3-xx	Spare label plate	PL-50
Retaining clip	HF-50	Transparent front cover	FA-50
Front panel mounting set	FZ-50L (Frame + retaining clip + socket with soldering connections)		



Connection diagram

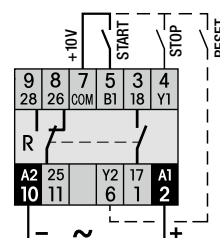


Fig.1 AC electrical endurance

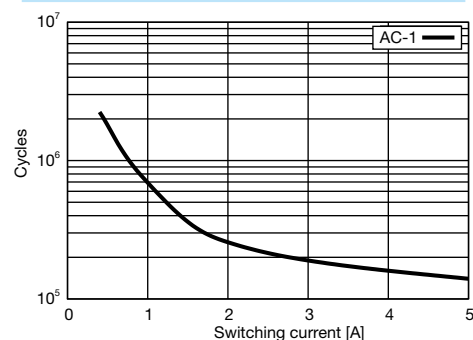
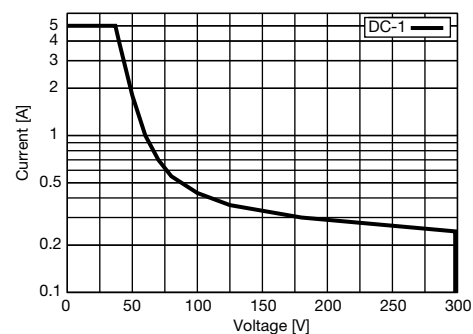
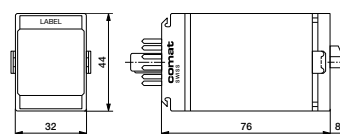


Fig. 2 DC load limit curve



Dimensions [mm]



Technical approvals, conformities

EN 60947



Time Relays 2.3

2

CS1

**11 pin plug-in time relay according to IEC 67-I-18a,
50 ms ... 60 minutes for wide band 12 ... 240 V operating voltage,
internal or external potentiometer operation**



Type: CS1/UC 12-240V R

Plug-in time relay

1 change over contact

UC 12-240 V operating voltage

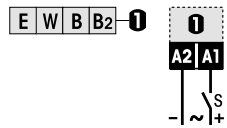
4 time functions, time ranges: 50 ms ... 60 min

LED for output state indication

Option for external fine adjustment time range potentiometer

Maximum contact load 8 A / 250 V AC-1
Recommended minimum contact load 10 mA / 10 V

Time functions and related connection diagrams (Function diagrams: refer to page 130)



External potentiometer (Pins 5, 7)

1 MΩ (see accessories)

Max. potentiometer cable length

50 m, shielded, GND on pin 5 (Z1)

Time data

5 partial time ranges, t_{max} (DIP switch)

Fine adjustment range (rotary knob)

Time range tolerance

Repetition accuracy

Reset time

Voltage failure buffering

0.6, 6, 60 s / 6, 60 min

$t_{min} \dots t_{max}$, 5 ... 60

t_{min} : -5 % ... +0 % / t_{max} : -0 % ... +5 %

± 0.1 % or DC: 2 ms / AC: 10 ms

≤ 30 ms

20 ms

Contacts

Type

Material

Rated operational current

Max. switching voltage AC-1

Max. AC load AC-1 (Fig.1)

Max. DC load DC-1, 30 V / 250 V (Fig.2)

1 CO, micro disconnection

AgNi

8 A

250 V

2000 VA

220 W / 75 W

Power supply- and control input (UC = AC / DC)

Nominal voltage (A1)

Operating voltage range

Power consumption

Frequency range

UC 12 ... 240 V

10.2 ... 265 V

≤ 1.4 W

45 ... 63 Hz

Insulation

Test voltage open contact

Test voltage between contacts and control input

1 kVrms 1 minute

2 kVrms 1 minute

General Specifications

Ambient temperature storage /operation

Mechanical life of contacts

Ingress protection degree

Housing material / Weight

-40 ... 85 °C / -25 ... 60 °C

≥ 30 x 10⁶ operations

IP 40 when plugged in

Lexan / 75 g

Standard types

UC (AC/DC)

CS1/UC12-240V R

Accessories

External potentiometer 1 M (Panel mounting + scale)

Socket

Retaining clip

Transparent front cover

Front panel mounting set

SP-01/1M

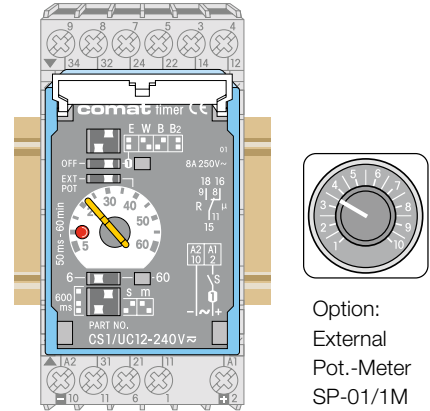
S3-xx

HF-50

FA-50

FZ-50L (Frame + retaining clip

+ socket with soldering connections)



Option:
External
Pot.-Meter
SP-01/1M

Connection diagram

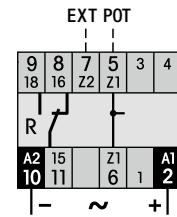


Fig.1 AC electrical endurance

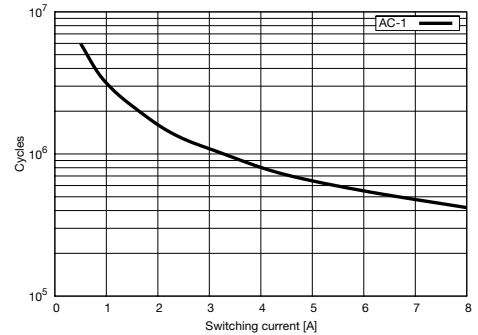
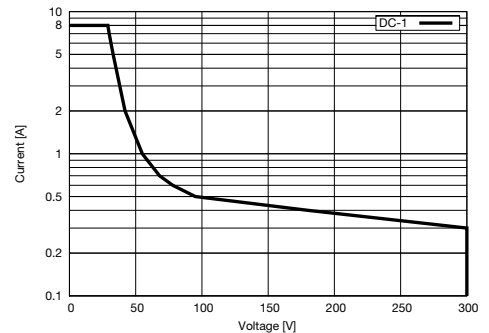
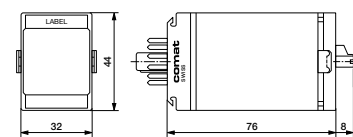


Fig. 2 DC load limit curve



Dimensions [mm]



Technical approvals, conformities



EN 60947

CS2

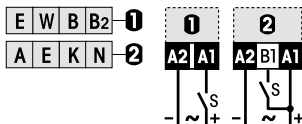
**11 pin plug-in time relay according to IEC 67-I-18a,
50 ms ... 60 h for wide band 12 ... 240 V operating voltage,
internal or external potentiometer operation**

Type: CS2/UC 12-240V R

Plug-in time relay
1 change over contact
UC 12-240 V operating voltage
7 time functions, time ranges: 50 ms ... 60 h
LED for output state indication
Option for external fine adjustment time range potentiometer

Maximum contact load 8 A / 250 V AC-1
Recommended minimum contact load 10 mA / 10 V

Time functions and related connection diagram (Function diagrams: refer to page 130)



External potentiometer pins 5, 7
1 M Ω (see accessories)
Max. potentiometer cable length
50 m, shielded, GND on pin5 (Z1)

Time data

7 partial time ranges, t_{max} (DIP switch) 0.6, 6, 60 s / 6, 60 min / 6, 60 h
Fine adjustment range (rotary knob) $t_{min} \dots t_{max}$, 5 ... 60
Time range tolerance t_{min} : -5 % ... +0 % / t_{max} : -0 % ... +5 %
Repetition accuracy ± 0.1 % or DC: 2 ms / AC: 10 ms
Min. trigger impulse on B1 ≥ 30 ms
Reset time ≤ 30 ms
Voltage failure buffering 20 ms

Contacts

Type 1 CO, micro disconnection
Material AgNi
Rated operational current 8 A
Max. switching voltage AC-1 250 V
Max. AC load AC-1 (Fig.1) 2000 VA
Max. DC load DC-1, 30 V / 250 V (Fig.2) 220 W / 75 W

Power supply- and control input (UC = AC / DC)

Nominal voltage (A1, B1) **UC 12 ... 240 V**
Operating voltage range 10.2 ... 265 V
Power consumption ≤ 1.4 W
Frequency range 45 ... 63 Hz
Allowed residual current into B1 AC / DC ≤ 2.3 mA / 1.2 mA
Trigger threshold voltage on B1, AC / DC 6.5 V / 7 V

Insulation

Test voltage open contact 1 kVrms 1 minute
Test voltage between contacts and control input 2 kVrms 1 minute

General Specifications

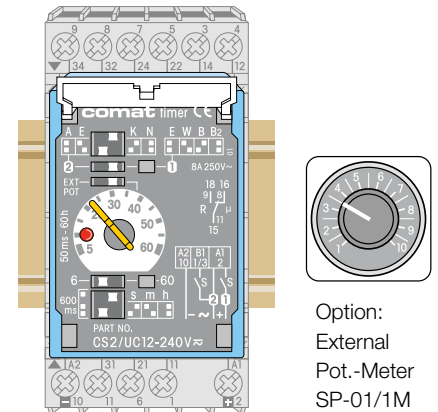
Ambient temperature storage /operation -40 ... 85 °C / -25 ... 60 °C
Mechanical life of contacts $\geq 30 \times 10^6$ operations
Ingress protection degree IP 40 when plugged in
Housing material / Weight Lexan / 75 g

Standard types

UC (AC/DC) **CS2/UC12-240V R**

Accessories

External potentiometer 1 M (Panel mounting + scale) **SP-01/1M**
Socket **S3-xx**
Retaining clip **HF-50**
Transparent front cover **FA-50**
Front panel mounting set **FZ-50L** (Frame + retaining clip + socket with soldering connections)



Option:
External
Pot.-Meter
SP-01/1M

Connection diagram

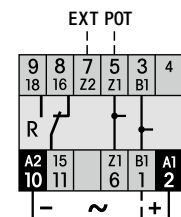


Fig.1 AC electrical endurance

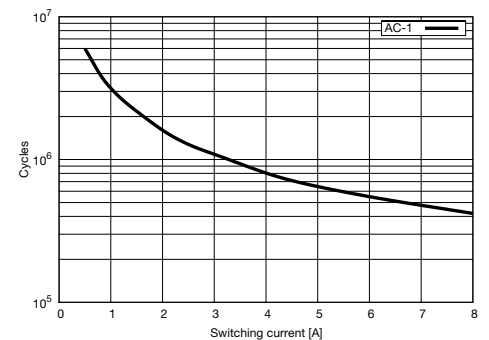
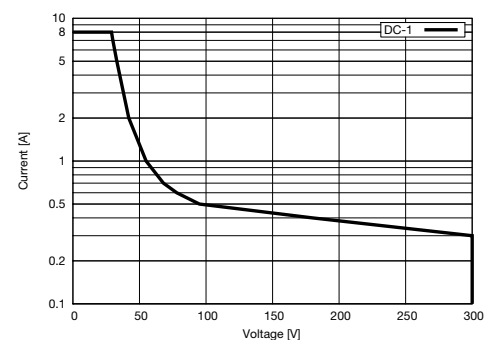
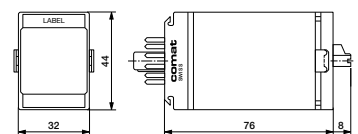


Fig. 2 DC load limit curve



Dimensions [mm]



Technical approvals, conformities



EN 60947

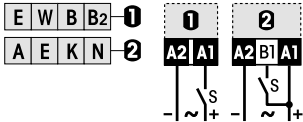
11 pin plug-in **time relay** according to IEC 67-1-18a, 50 ms ... 60 h
for wide band 12 ... 240 V operating voltage, **2 change over output contacts**

Type: CS3/UC 12-240V R

Plug-in time relay
2 change over contacts
UC 12-240 V operating voltage
7 time functions, time ranges: 50 ms ... 60 h
LED for output state indication

Maximum contact load	6 A / 250 V AC-1
Recommended minimum contact load	10 mA / 10 V

Time functions and related connection diagrams (Function diagrams: refer to page 130)



Time data

7 partial time ranges, t_{max} (DIP switch)	0.6, 6, 60 s / 6, 60 min / 6, 60 h
Fine adjustment range (rotary knob)	$t_{min} \dots t_{max}$, 5 ... 60
Time range tolerance	t_{min} : -5 % ... +0 % / t_{max} : -0 % ... +5 %
Repetition accuracy	± 0.1 % or DC: 2 ms / AC: 10 ms
Min. trigger start impulse on B1	≥ 30 ms
Reset time	≤ 30 ms
Voltage failure buffering	20 ms

Contacts

Type	2 CO, micro disconnection
Material	AgNi
Rated operational current	6 A
Max. switching voltage AC-1	250 V
Max. AC load AC-1 (Fig.1)	1500 VA
Max. DC load DC-1, 30 V / 250 V (Fig.2)	180 W / 60 W

Power supply- and control input (UC = AC / DC)

Nominal voltage (A1, B1)	UC 12 ... 240 V
Operating voltage range	10.2 ... 265 V
Power consumption	≤ 1.4 W
Frequency range	45 ... 63 Hz
Allowed residual current into B1 AC / DC	≤ 2.3 mA / 1.2 mA
Trigger threshold voltage on B1, AC / DC	6.5 V / 7 V

Insulation

Test voltage open contact	1 kVrms 1 minute
Test voltage between poles	2 kVrms 1 minute
Test voltage between contacts and control input	2 kVrms 1 minute

General Specifications

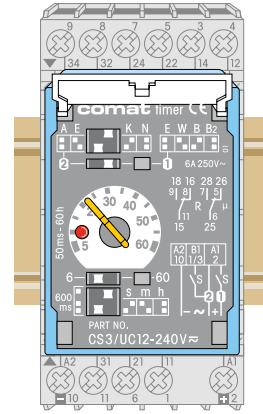
Ambient temperature storage /operation	-40 ... 85 °C / -25 ... 60 °C
Mechanical life of contacts	≥ 30 x 10 ⁶ operations
Ingress protection degree	IP 40 when plugged in
Housing material / Weight	Lexan / 75 g

Standard types

UC (AC/DC)	CS3/UC12-240V R
-------------------	------------------------

Accessories

Socket:	S3-xx
Retaining clip	HF-50
Transparent front cover	FA-50
Front panel mounting set	FZ-50L (Frame + retaining clip + socket with soldering connections)



Connection diagram

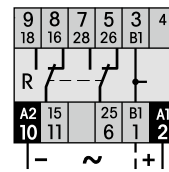


Fig.1 AC electrical endurance

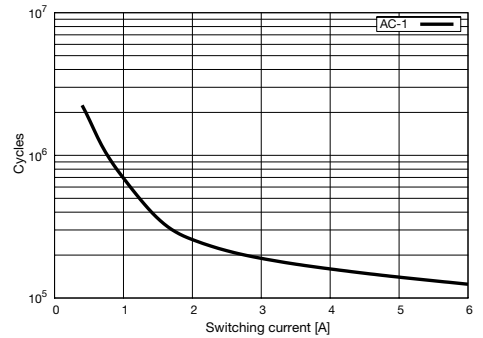
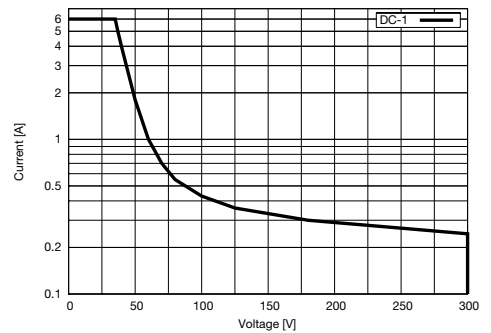
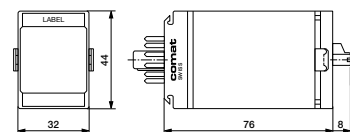


Fig. 2 DC load limit curve



Dimensions [mm]



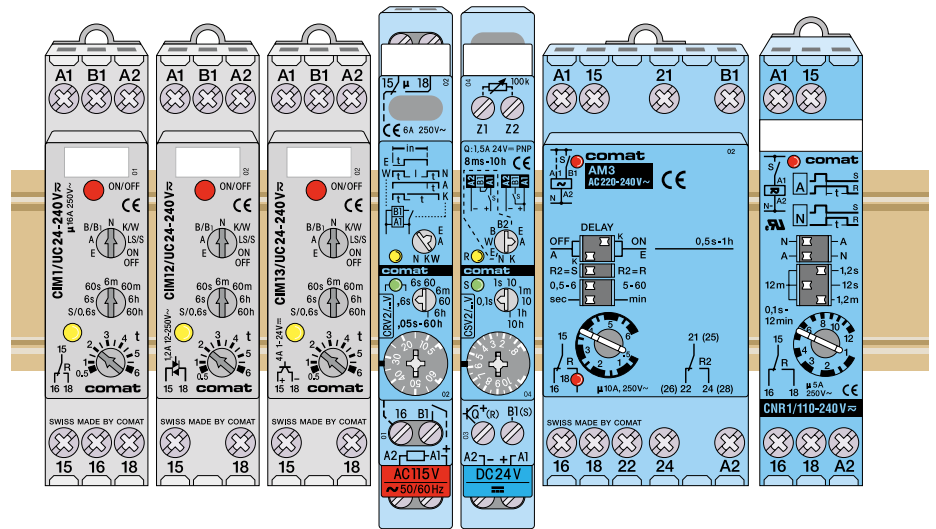
Technical approvals, conformities



EN 60947

2.4 DIN Time Relays

DIN Time Relays



Application	Types	Functions	Min. time	Max. time	Contact rating	Design
Universal time relay, 8 time functions & stepping function, ON/OFF switch, service function	CIM1	E, B, W, A, K, N, B1, S, LS	50 ms	60 h	16 A / 250 V	17.5 mm
Universal time relay, 8 time functions & stepping function, ON/OFF switch, AC solid state output	CIM12	E, B, W, A, K, N, B1, S, LS	50 ms	60 h	2 A / 250 V	17.5 mm
Universal time relay, 8 time functions & stepping function, ON/OFF switch, DC solid state output	CIM13	E, B, W, A, K, N, B1, S, LS	50 ms	60 h	5 A / 24 V DC	17.5 mm
Universal time relay, 7 time functions, ON/OFF switch, service function	CIM2	E, A, L, M, G, B2, H	50 ms	60 h	16 A / 250 V	17.5 mm
Universal time relay, 7 time functions, ON/OFF switch, service function, AC solid state output	CIM22	E, A, L, M, G, B2, H	50 ms	60 h	2 A / 250 V	17.5 mm
Universal time relay, 7 time functions, ON/OFF switch, service function, DC solid state output	CIM23	E, A, L, M, G, B2, H	50 ms	60 h	5 A / 24 V DC	17.5 mm
Universal time relay, 6 time functions, ON/OFF switch, service function	CIM3	F, Q, G, H, I, P	50 ms	60 h	16 A / 250 V	17.5 mm
Universal time relay, 6 time functions, ON/OFF switch, service function, AC solid state output	CIM32	F, Q, G, H, I, P	50 ms	60 h	2 A / 250 V	17.5 mm
Universal time relay, 6 time functions, ON/OFF switch, service function, DC solid state output	CIM33	F, Q, G, H, I, P	50 ms	60 h	5 A / 24 V DC	17.5 mm
Universal timer, ON-OFF switch, 2 CO contacts	CM3	E, A, K, N, B1, B, W	50 ms	60 h	5 A / 250 V	17.5 mm
Multi function	CRV2	E, W, A, K, N	0.05 s	60 h	6 A / 250 V	13 mm
Double time relay	CRV3	F, Q	2x 50 ms	2x 60 h	6 A / 250 V	13 mm
Multi function, external potentiometer, solid state output	CSV2	E, W, B, B2, E, A, K, N	8 ms	10 h	1.5 A / 30 V	13 mm
Multifunction time relay	AM2	E, A, K, W	0.5 s	60 min	10 A / 250 V	17.5 mm
Universal timer with instantaneous contact	AM3	E, A, K, W	0.5 s	60 min	10 A / 250 V	35 mm
Time run without auxiliary voltage	CNR1	A, N	0.1 s	12 min	5 A / 250 V	17.5 mm
Pulse shaper	CPF11	K, L, A	5 ms	600 ms	0.8 A / 24 V	17.5 mm
Star-Delta time relay	CY1	Y	0.5 s	60 s	6 A / 250 V	17.5 mm

(Function diagrams: refer to page 130)

CIM1, CIM1R (Railway)

Time relay with mechanical changeover output contact
8 time functions + stepping function, ON-OFF switch, 50 ms ... 60 h,
DIN Rail mounting according to DIN 43 880



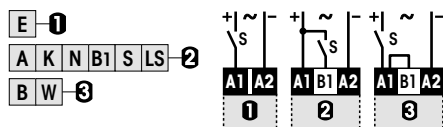
Type: CIM1/UC24-240V

Sophisticated multifunction time relay, 1 changeover power contact with zero crossing switching (50/60 Hz), 8 time functions, stepping function and service function ON/OFF, time ranges: 50 ms ... 60 h, multifunction LED state indicator, suitable for any time-control application and also staircase lighting, Light-switch neon lamp current absorption on input B1, Manual switching function for maintenance, emergency, etc., 16.6 Hz power supply applications. Railway version available.

Maximum contact load 16 A / 250 V AC-1 384 W DC-1
Recommended minimum contact load 10 mA / 10 V

Time functions and related connection diagrams (Function diagrams: refer to page 130)

The functions are selectable by rotary switch



LED function table:

LED	Relay	Time run
OFF	OFF	NO
Continuous ON	ON	NO
Short blinking	OFF	YES
Long blinking	ON	YES

Time data

7 partial time ranges, t_{max} (rotary switch)	0.6, 6, 60 s / 6, 60 min / 6, 60 h
Fine adjustment range (rotary knob)	$t_{min} \dots t_{max}$: 0.5 ... 6
Time range tolerance	t_{min} : -5 % ... +0 % / t_{max} : -0 % ... +5 %
Repetition accuracy	± 0.1 % or DC: 2 ms / AC: 10 ms
Response time, power on, on A1	≤ 45 ms
Min. trigger pulse on B1	20 ms (AC / DC)
Reset time B1 (AC/DC)	≤ 30 ms
Voltage failure buffering (50 / 60 Hz)	≥ 20 ms

Contacts

Material CIM1 / CIM1R / Type	AgNi / 1 CO, micro disconnection
Rated operational current at 40 °C / 60 °C	16 A / 13 A
Max. inrush current	30 A
Max. switching voltage AC-1	250 V
Max. AC load AC-1 (Fig.1)	4 kVA
Max. DC load DC-1 30 V / 250 V (Fig.2)	240 W / 85 W

Power supply- and control input

Nominal voltage (A1, B1)	UC 24-240 V (UC = AC / DC)
Operating voltage range	UC 19 ... 250 V
Power consumption	approx. 1 W
Frequency range	15 ... 60 Hz
Allowed DC residual current into B1	≤ 0.5 mA
AC Neon lamp residual current into B1	≤ 10 mA
Trigger threshold voltage on B1, AC / DC	15 / 17 V

Insulation

Test voltage open contact	1 kVrms 1 minute
Test voltage between contacts and control input	2.5 kVrms 1 minute

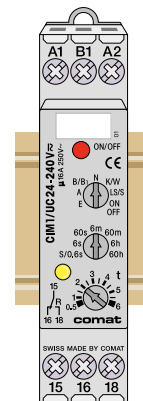
General Specifications

Ambient temperature storage /operation	-40 ... 85 °C / -40 ...60 °C (Railway: -46 °C)
Mechanical life of contact	30 x 10 ⁶ operations
Conductor cross section	Stranded wire 2.5 mm ² , 2 x 1.5 mm ²
Ingress protection degree	IP 20
Max. Screw torque	0.4 Nm
Housing material / weight	Lexan / 70 g

Standard types

UC (AC/DC) 15...60 Hz
Railway

CIM1/UC24-240V
CIM1R/UC24-240V



Connection diagram

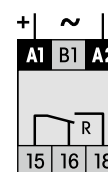


Fig.1 AC voltage endurance

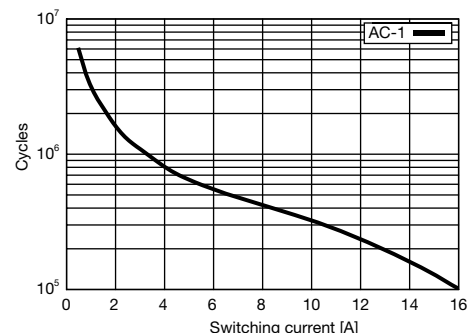
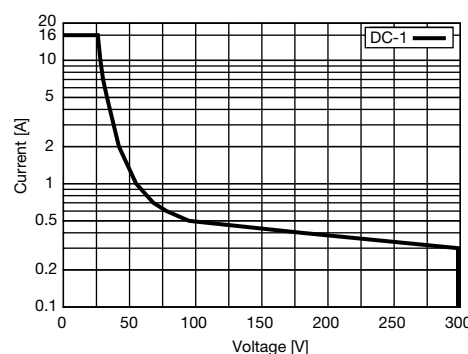
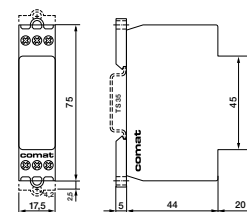


Fig. 2 DC load limit curve



Dimensions [mm]



Technical approvals, conformities

EN 50155, EN 60730



CIM12, CIM12R (Railway)

Time relay with AC solid-state output

8 time functions and stepping function, ON-OFF switch, 50 ms ... 60 h, DIN Rail mounting according to DIN 43 880



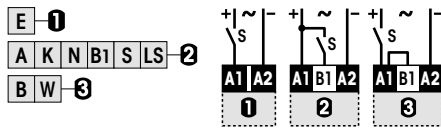
Type: CIM12/UC24-240V

Sophisticated multifunction time relay, 1 triac output, suitable for high frequency of operations and inductive loads, 8 time functions, stepping function and service function ON/OFF, time ranges: 50 ms ... 60 h, multifunction LED state indicator, suitable for any time-control application and also staircase lighting, Light-switch neon lamp current absorption on input B1, manual switching function for maintenance, emergency, etc., 16.6 Hz applications. Railway version available.

Maximum contact load	2 A / 250 V
Minimum contact load	50 mA

Time functions and related connection diagrams (Function diagrams: refer to page 130)

The functions are selectable by rotary switch



LED function table:

LED	Relay	Time run
OFF	OFF	NO
Continuous ON	ON	NO
Short blinking	OFF	YES
Long blinking	ON	YES

Time data

7 partial time ranges, t_{max} (rotary switch)	0.6, 6, 60 s / 6, 60 min / 6, 60 h
Fine adjustment range (rotary knob)	$t_{min} \dots t_{max}$ 0.5 ... 6
Time range tolerance	t_{min} : -5 % ... +0 % / t_{max} : -0 % ... +5 %
Repetition accuracy	± 0.1 % or DC: 2 ms / AC: 10 ms
Response time, power on, on A1	≤ 45 ms
Min. trigger pulse on B1	20 ms (AC / DC)
Reset time B1 (AC/DC)	≤ 30 ms
Voltage failure buffering (50 / 60 Hz)	≥ 20 ms

Output

Type	Triac, zero crossing
Rated operational current at 40 °C (Fig.1)	2 A
Max. inrush current (10 ms)	100 A
Max. switching voltage	250 V
Max. AC load AC-1	300 VA
I^2t value	78 A ² s
Leakage current	< 1 mA

Power supply- and control input

Nominal voltage	UC 24-240 V (UC = AC / DC)
Operating voltage range	UC 19 ... 250 V
Power consumption	approx. 1 W
Frequency range	15 ... 60 Hz
Allowed DC residual current into B1	≤ 0.5 mA
AC Neon lamp residual current into B1	≤ 10 mA
Trigger threshold voltage on B1, AC / DC	15 / 17 V

Insulation

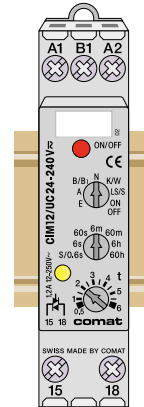
Test voltage between output and control input	2.5 kVrms 1 minute
---	--------------------

General Specifications

Ambient temperature storage / operation	-40 ... 85 °C / -40 ... 60 °C (Railway: -70 °C)
Conductor cross section	Stranded wire 2.5 mm ² , 2 x 1.5 mm ²
Ingress protection degree	IP 20
Max. Screw torque	0.4 Nm
Housing material / weight	Lexan / 70 g

Standard types

UC (AC/DC), 15...60 Hz	CIM12/UC24-240V
Railway	CIM12R/UC24-240V



Connection diagram

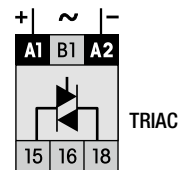
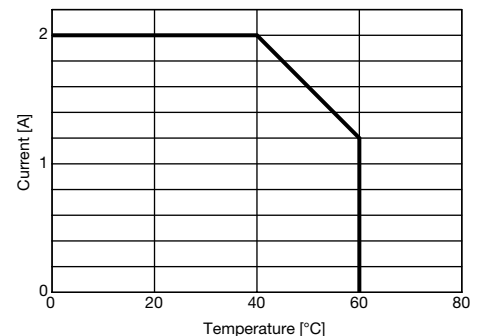
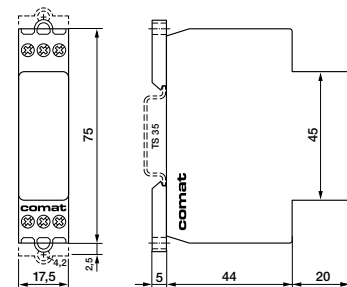


Fig. 1 Output derating curve



Dimensions [mm]



Technical approvals, conformities

EN 50155, EN 60730



CIM13, CIM13R (Railway)

Time relay with DC solid-state output

8 time functions and stepping function, ON-OFF switch, 50 ms ... 60 h

DIN Rail mounting according to DIN 43 880



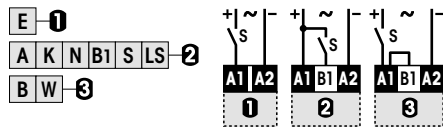
Type: CIM13/UC24-240V

Sophisticated multifunction time relay, 1 transistor output, 8 time functions, stepping function and service function ON/OFF, time ranges from 50 ms ... 60 h, multifunction LED state indicator, suitable for any time-control application and also staircase-light control, light-switch neon lamp current absorption on input B1, manual switching function for maintenance, emergency, etc., 16.6 Hz applications. Railway version available.

Maximum contact load 4 A / 30 V
Recommended minimum contact load 1 mA

Time functions and related connection diagrams (Function diagrams: refer to page 130)

The functions are selectable by rotary switch



LED function table:

LED	Relay	Time run
OFF	OFF	NO
Continuous ON	ON	NO
Short blinking	OFF	YES
Long blinking	ON	YES

Time data

7 partial time ranges, t_{max} (rotary switch)	0.6, 6, 60 s / 6, 60 min / 6, 60 h
Fine adjustment range (rotary knob)	$t_{min} \dots t_{max}$, 0.5 ... 6
Time range tolerance	t_{min} : -5 % ... +0 % / t_{max} : -0 % ... +5 %
Repetition accuracy	± 0.1 % or DC: 2 ms / AC: 10 ms
Response time, power on, on A1	≤ 45 ms
Min. trigger pulse on B1	20 ms (AC / DC)
Reset time B1 (AC/DC)	≤ 30 ms
Voltage failure buffering (50 / 60 Hz)	≥ 20 ms

Output

Type	MOS FET
Rated operational current (Fig. 1)	4 A
Max. inrush current (10 μ s)	40 A
Max. switching voltage	30 V
Leakage current	$< 10 \mu$ A

Power supply- and control input

Nominal voltage (UC = AC / DC)	UC 24-240 V (UC = AC / DC)
Operating voltage range	UC 19 ... 250 V
Power consumption	approx. 1 W
Frequency range	15 ... 60 Hz
Allowed DC residual current into B1	≤ 0.5 mA
AC Neon lamp residual current into B1	≤ 10 mA
Trigger threshold voltage on B1, AC / DC	15 / 17 V

Insulation

Test voltage between output and control input	2.5 kVrms 1 minute
---	--------------------

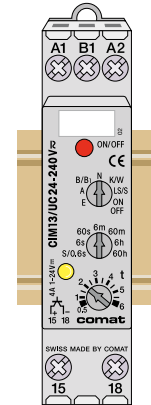
General Specifications

Ambient temperature storage /operation	-40 ... 85 °C / -40 ... 60 °C (Railway: -70 °C)
Conductor cross section	Stranded wire 2.5 mm ² , 2 x 1.5 mm ²
Ingress protection degree	IP 20
Max. Screw torque	0.4 Nm
Housing material / Weight	Lexan / 70 g

Standard types

UC (AC/DC), 15...60 Hz
Railway

CIM13/UC24-240V
CIM13R/UC24-240V



Connection diagram

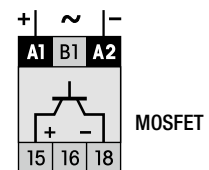
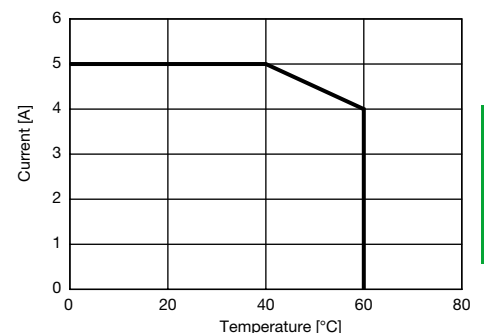
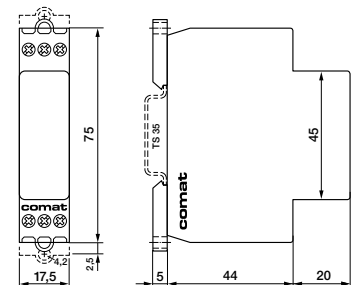


Fig. 1 Output derating curve



Dimensions [mm]



Technical approvals, conformities

EN 50155; EN 60730



CIM2, CIM2R (Railway)

Time relay with mechanical changeover output contact
7 time functions and 7 time ranges from 50 ms ... 60 h,
DIN Rail mounting according to DIN 43 880



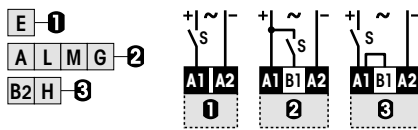
Type: CIM2/UC24-240V

Sophisticated multifunction time relay, 1 changeover power contact switching in zero crossing (50/60 Hz), 7 time functions and service function ON/OFF, 7 time ranges from 50 ms to 60 h, multifunction LED state indicator, suitable for any time-control application, light-switch neon lamp current absorption on input B1, manual switching function for maintenance, emergency, etc., 16.6 Hz power supply applications. Railway version available.

Maximum contact load 16 A / 250 V AC-1 384 W DC-1
Recommended minimum contact load 10 mA / 10 V

Time functions and related connection diagrams (Function diagrams: refer to page 130)

The functions are selectable by rotary switch



LED function table:

LED	Relay	Time run
OFF	OFF	NO
Continuous ON	ON	NO
Short blinking	OFF	YES
Long blinking	ON	YES

Time data

7 partial time ranges, t_{max} (rotary switch)	0.6, 6, 60 s / 6, 60 min / 6, 60 h
Fine adjustment range (rotary knob)	$t_{min} \dots t_{max} \cdot 0.5 \dots 6$
Time range tolerance	t_{min} : -5 % ... +0 % / t_{max} : -0 % ... +5 %
Repetition accuracy	± 0.1 % or DC: 2 ms / AC: 10 ms
Response time, power on, on A1	≤ 45 ms
Min. trigger pulse on B1	20 ms (AC / DC)
Reset time B1 (AC/DC)	≤ 30 ms
Voltage failure buffering (50 / 60 Hz)	≥ 20 ms

Contacts

Material CIM2 / CIM2R / Type	AgNi / 1 CO, micro disconnection
Rated operational current at 40 °C / 60 °C	16 A / 13 A
Max. inrush current	30 A
Max. switching voltage AC-1	250 V
Max. AC load AC-1 (Fig.1)	4 kVA
Max. DC load DC-1 30 V / 250 V (Fig.2)	240 W / 85 W

Power supply- and control input

Nominal voltage (A1, B1)	UC 24-240 V (UC = AC / DC)
Operating voltage range	UC 19 ... 250 V
Power consumption	approx. 1 W
Frequency range	15 ... 60 Hz
Allowed DC residual current into B1	≤ 0.5 mA
AC Neon lamp residual current into B1	≤ 10 mA
Trigger threshold voltage on B1, AC / DC	15 / 17 V

Insulation

Test voltage open contact	1 kVrms 1 minute
Test voltage between contacts and control input	2.5 kVrms 1 minute

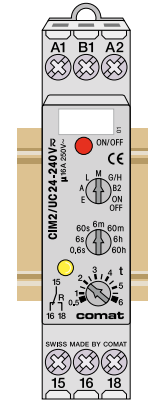
General Specifications

Ambient temperature storage / operation	-40 ... 85 °C / -40 ... 60 °C (Railway: -46 °C)
Mechanical life of contact	30 x 10 ⁶ operations
Conductor cross section	Stranded wire 2.5 mm ² , 2 x 1.5 mm ²
Ingress protection degree	IP 20
Max. Screw torque	0.4 Nm
Housing material / weight	Lexan / 70 g

Standard types

UC (AC/DC) 15...60 Hz
Railway

CIM2/UC24-240V
CIM2R/UC24-240V



Connection diagram

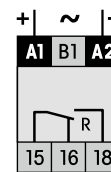


Fig.1 AC voltage endurance

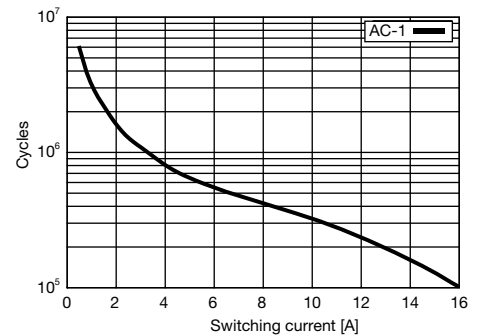
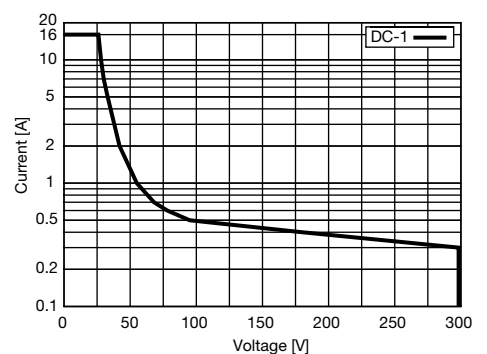
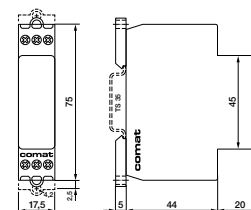


Fig. 2 DC load limit curve



Dimensions [mm]



Technical approvals, conformities

EN 50155, EN 60730



CIM22, CIM22R (Railway)

Time relay with AC solid-state output

7 time functions and 7 time ranges 50 ms ... 60 h,
DIN Rail mounting according to DIN 43 880



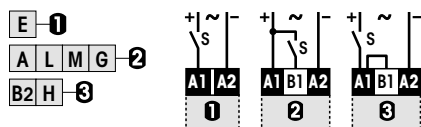
Type: CIM22/UC24-240V

Sophisticated multifunction time relay, 1 triac output, suitable for high frequency of operations and inductive loads, 7 time functions and service function ON/OFF, 7 time ranges from 50 ms ... 60 h, multifunction LED state indicator, suitable for any time-control application light-switch neon lamp current absorption on input B1, manual switching function for maintenance, emergency, etc., 16.6 Hz applications. Railway version available.

Maximum contact load 2 A / 250 V
Minimum contact load 50 mA

Time functions and related connection diagrams (Function diagrams: refer to page 130)

The functions are selectable by rotary switch



LED function table:

LED	Relay	Time run
OFF	OFF	NO
Continuous ON	ON	NO
Short blinking	OFF	YES
Long blinking	ON	YES

Time data

7 partial time ranges, t_{max} (rotary switch) 0.6, 6, 60 s / 6, 60 min / 6, 60 h
 Fine adjustment range (rotary knob) $t_{min} \dots t_{max}$, 0.5 ... 6
 Time range tolerance t_{min} : -5 % ... +0 % / t_{max} : -0 % ... +5 %
 Repetition accuracy ± 0.1 % or DC: 2 ms / AC: 10 ms
 Response time, power on, on A1 ≤ 45 ms
 Min. trigger pulse on B1 20 ms (AC / DC)
 Reset time B1 (AC/DC) ≤ 30 ms
 Voltage failure buffering (50 / 60 Hz) ≥ 20 ms

Output

Type Triac, zero crossing
 Rated operational current at 40 °C (Fig.1) 2 A
 Max. inrush current (10 ms) 100 A
 Max. switching voltage 250 V
 Max. AC load AC-1 300 VA
 I^2t value 78 A²s
 Leakage current < 1 mA

Power supply- and control input

Nominal voltage **UC 24-240 V (UC = AC / DC)**
 Operating voltage range UC 19 ... 250 V
 Power consumption approx. 1 W
 Frequency range 15 ... 60 Hz
 Allowed DC residual current into B1 ≤ 0.5 mA
 AC Neon lamp residual current into B1 ≤ 10 mA
 Trigger threshold voltage on B1, AC / DC 15 / 17 V

Insulation

Test voltage between output and control input 2.5 kVrms 1 minute

General Specifications

Ambient temperature storage /operation -40 ... 85 °C / -40 ... 60 °C (Railway: -70 °C)
 Conductor cross section Stranded wire 2.5 mm², 2 x 1.5 mm²
 Ingress protection degree IP 20
 Max. Screw torque 0.4 Nm
 Housing material / weight Lexan / 70 g

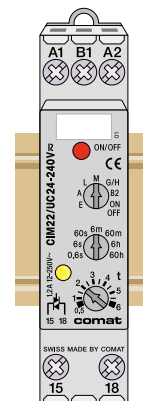
Standard types

UC (AC/DC), 15...60 Hz

Railway

CIM22/UC24-240V

CIM22R/UC24-240V



Connection diagram

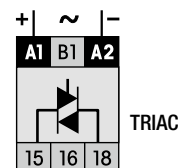
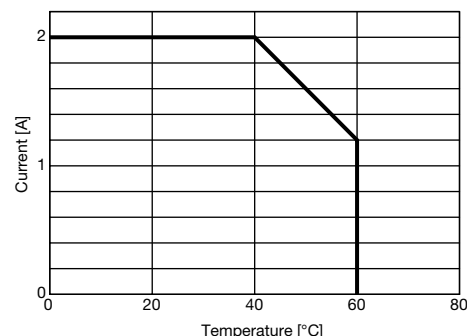
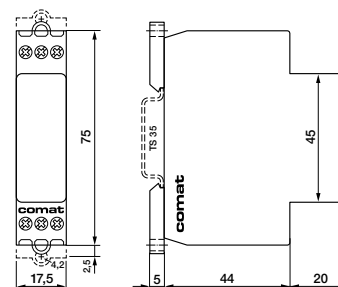


Fig. 1 Output derating curve



Dimensions [mm]



Technical approvals, conformities

EN 50155, EN 60730



CIM23, CIM23R (Railway)

Time relay with DC solid-state output

7 time functions and 7 time ranges from 50 ms ... 60 h

DIN Rail mounting according to DIN 43 880



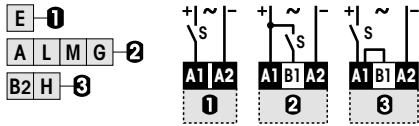
Type: CIM23/UC24-240V

Sophisticated multifunction time relay, 1 transistor output, 7 time functions and service function ON/OFF, 7 time ranges from 50 ms ... 60 h, multifunction LED state indicator suitable for any time-control application, light-switch neon lamp current absorption on input B1, manual switching function for maintenance, emergency, etc., 16.6 Hz applications. Railway version available.

Maximum contact load 4 A / 30 V
Recommended minimum contact load 1 mA

Time functions and related connection diagrams (Function diagrams: refer to page 130)

The functions are selectable by rotary switch



LED function table:

LED	Relay	Time run
OFF	OFF	NO
Continuous ON	ON	NO
Short blinking	OFF	YES
Long blinking	ON	YES

Time data

7 partial time ranges, t_{max} (rotary switch)	0.6, 6, 60 s / 6, 60 min / 6, 60 h
Fine adjustment range (rotary knob)	$t_{min} \dots t_{max}$: 0.5 ... 6
Time range tolerance	t_{min} : -5 % ... +0 % / t_{max} : -0 % ... +5 %
Repetition accuracy	± 0.1 % or DC: 2 ms / AC: 10 ms
Response time, power on, on A1	≤ 45 ms
Min. trigger pulse on B1	20 ms (AC / DC)
Reset time B1 (AC/DC)	≤ 30 ms
Voltage failure buffering (50 / 60 Hz)	≥ 20 ms

Output

Type	MOS FET
Rated operational current (Fig. 1)	4 A
Max. inrush current (10 μs)	40 A
Max. switching voltage	30 V
Leakage current	< 10 μA

Power supply- and control input

Nominal voltage (UC = AC / DC)	UC 24-240 V (UC = AC / DC)
Operating voltage range	UC 19 ... 250 V
Power consumption	approx. 1 W
Frequency range	15 ... 60 Hz
Allowed DC residual current into B1	≤ 0.5 mA
AC Neon lamp residual current into B1	≤ 10 mA
Trigger threshold voltage on B1, AC / DC	15 / 17 V

Insulation

Test voltage between output and control input	2.5 kVrms 1 minute
---	--------------------

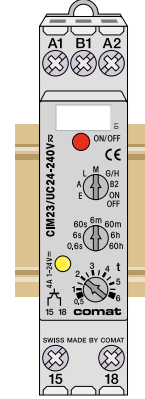
General Specifications

Ambient temperature storage /operation	-40 ... 85 °C / -40 ... 60 °C (Railway: -70 °C)
Conductor cross section	Stranded wire 2.5 mm ² , 2 x 1.5 mm ²
Ingress protection degree	IP 20
Max. Screw torque	0.4 Nm
Housing material / Weight	Lexan / 70 g

Standard types

UC (AC/DC), 15...60 Hz
Railway

CIM23/UC24-240V
CIM23R/UC24-240V



Connection diagram

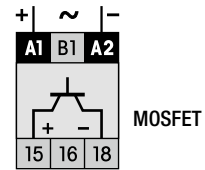
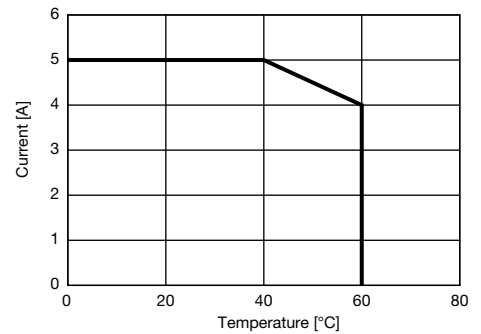
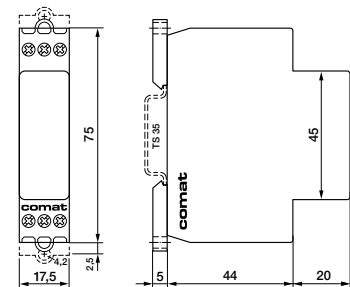


Fig. 1 Output derating curve



Dimensions [mm]



Technical approvals, conformities

EN 50155; EN 60730



CIM3, CIM3R (Railway)

Time relay with mechanical changeover output contact
6 time functions and service function, 7 time ranges from 50 ms...60 h,
DIN Rail mounting according to DIN 43 880



comat
RELECO
 WORLD OF RELAYS

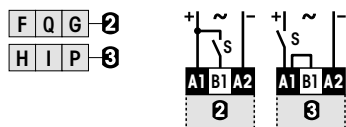
Type: CIM3/UC24-240V

Sophisticated multifunction time relay, 1 changeover power contact switching in zero crossing (50/60 Hz), 6 time functions and service function ON/OFF, 7 time ranges from 50 ms to 60 h, multifunction LED state indicator, suitable for any time-control application, light-switch neon lamp current absorption on input B1, manual switching function for maintenance, emergency, etc., 16.6 Hz power supply applications. Railway version available.

Maximum contact load 16 A / 250 V AC-1 384 W DC-1
Recommended minimum contact load 10 mA / 10 V

Time functions and related connection diagrams (Function diagrams: refer to page 130)

The functions are selectable by rotary switch



LED function table:

LED	Relay	Time run
OFF	OFF	NO
Continuous ON	ON	NO
Short blinking	OFF	YES
Long blinking	ON	YES

Time data

7 partial time ranges, t_{max} (rotary switch) 0.6, 6, 60 s / 6, 60 min / 6, 60 h
 Fine adjustment range (rotary knob) $t_{min} \dots t_{max}$, 0.5 ... 6
 Time range tolerance t_{min} : -5 % ... +0 % / t_{max} : -0 % ... +5 %
 Repetition accuracy ± 0.1 % or DC: 2 ms / AC: 10 ms
 Response time, power on, on A1 ≤ 45 ms
 Min. trigger pulse on B1 20 ms (AC / DC)
 Reset time B1 (AC/DC) ≤ 30 ms
 Voltage failure buffering (50 / 60 Hz) ≥ 20 ms

Contacts

Material CIM3 / CIM3R / Type AgNi / 1 CO, micro disconnection
 Rated operational current at 40 °C / 60 °C 16 A / 13 A
 Max. inrush current 30 A
 Max. switching voltage AC-1 250 V
 Max. AC load AC-1 (Fig.1) 4 kVA
 Max. DC load DC-1 30 V / 250 V (Fig.2) 240 W / 85 W

Power supply- and control input

Nominal voltage (A1, B1) **UC 24-240 V (UC = AC / DC)**
 Operating voltage range UC 19 ... 250 V
 Power consumption approx. 1 W
 Frequency range 15 ... 60 Hz
 Allowed DC residual current into B1 ≤ 0.5 mA
 AC Neon lamp residual current into B1 ≤ 10 mA
 Trigger threshold voltage on B1, AC / DC 15 / 17 V

Insulation

Test voltage open contact 1 kVrms 1 minute
 Test voltage between contacts and control input 2.5 kVrms 1 minute

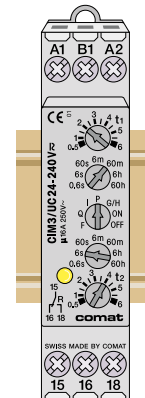
General Specifications

Ambient temperature storage /operation -40 ... 85 °C / -40 ...60 °C (Railway: -46 °C)
 Mechanical life of contact 30×10^6 operations
 Conductor cross section Stranded wire 2.5 mm², 2 x 1.5 mm²
 Ingress protection degree IP 20
 Max. Screw torque 0.4 Nm
 Housing material / weight Lexan / 70 g

Standard types

UC (AC/DC) 15...60 Hz
Railway

CIM3/UC24-240V
CIM3R/UC24-240V



Connection diagram

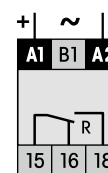


Fig.1 AC voltage endurance

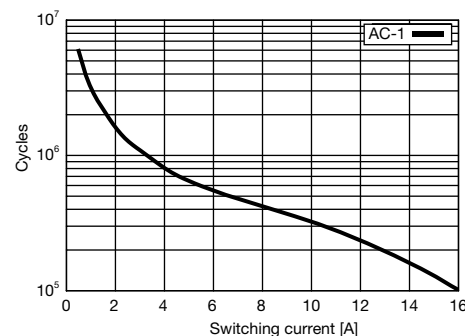
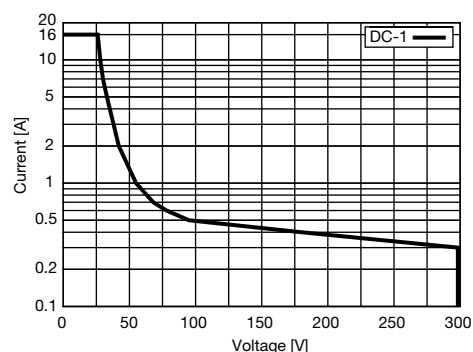
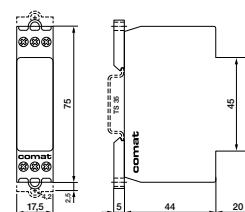


Fig. 2 DC load limit curve



Dimensions [mm]



Technical approvals, conformities

EN 50155, EN 60730



CIM32, CIM32R (Railway)

Time relay with AC solid-state output

6 time functions and service function, 7 time ranges from 50 ms...60 h, DIN Rail mounting according to DIN 43 880



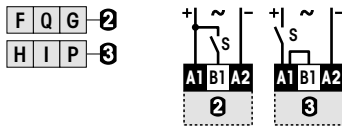
Type: CIM32/UC24-240V

Sophisticated multifunction time relay, 1 triac output, suitable for high frequency of operations and inductive loads, 6 time functions and service function ON/OFF, 7 time ranges from 50 ms ... 60 h, multifunction LED state indicator, suitable for any time-control application light-switch neon lamp current absorption on input B1, manual switching function for maintenance, emergency, etc., 16.6 Hz applications. Railway version available.

Maximum contact load	2 A / 250 V
Minimum contact load	50 mA

Time functions and related connection diagrams (Function diagrams: refer to page 130)

The functions are selectable by rotary switch



LED function table:

LED	Relay	Time run
OFF	OFF	NO
Continuous ON	ON	NO
Short blinking	OFF	YES
Long blinking	ON	YES

Time data

7 partial time ranges, t_{max} (rotary switch)	0.6, 6, 60 s / 6, 60 min / 6, 60 h
Fine adjustment range (rotary knob)	$t_{min} \dots t_{max}$, 0.5 ... 6
Time range tolerance	t_{min} : -5 % ... +0 % / t_{max} : -0 % ... +5 %
Repetition accuracy	± 0.1 % or DC: 2 ms / AC: 10 ms
Response time, power on, on A1	≤ 45 ms
Min. trigger pulse on B1	20 ms (AC / DC)
Reset time B1 (AC/DC)	≤ 30 ms
Voltage failure buffering (50 / 60 Hz)	≥ 20 ms

Output

Type	Triac, zero crossing
Rated operational current at 40 °C (Fig.1)	2 A
Max. inrush current (10 ms)	100 A
Max. switching voltage	250 V
Max. AC load AC-1	300 VA
I ² t value	78 A ² s
Leakage current	< 1 mA

Power supply- and control input

Nominal voltage	UC 24-240 V (UC = AC / DC)
Operating voltage range	UC 19 ... 250 V
Power consumption	approx. 1 W
Frequency range	15 ... 60 Hz
Allowed DC residual current into B1	≤ 0.5 mA
AC Neon lamp residual current into B1	≤ 10 mA
Trigger threshold voltage on B1, AC / DC	15 / 17 V

Insulation

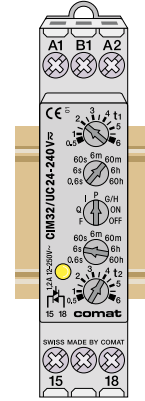
Test voltage between output and control input	2.5 kVrms 1 minute
---	--------------------

General Specifications

Ambient temperature storage / operation	-40 ... 85 °C / -40 ... 60 °C (Railway: -70 °C)
Conductor cross section	Stranded wire 2.5 mm ² , 2 x 1.5 mm ²
Ingress protection degree	IP 20
Max. Screw torque	0.4 Nm
Housing material / weight	Lexan / 70 g

Standard types

UC (AC/DC), 15...60 Hz	CIM32/UC24-240V
Railway	CIM32R/UC24-240V



Connection diagram

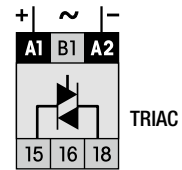
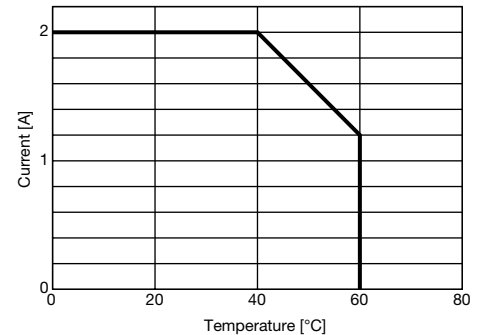
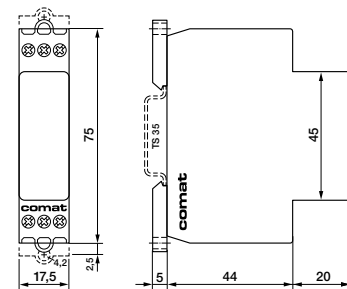


Fig. 1 Output derating curve



Dimensions [mm]



Technical approvals, conformities

EN 50155, EN 60730



CIM33, CIM33R (Railway)

Time relay with DC solid-state output

6 time functions and service function, 7 time ranges from 50 ms...60 h, DIN Rail mounting according to DIN 43 880



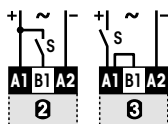
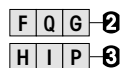
Type: CIM33/UC24-240V

Sophisticated multifunction time relay, 1 transistor output, 6 time functions and service function ON/OFF, 7 time ranges from 50 ms ... 60 h, Multifunction LED state indicator, suitable for any time-control application, light-switch neon lamp current absorption on input B1, manual switching function for maintenance emergency, etc., 16.6 Hz applications. Railway version available.

Maximum contact load 4 A / 30 V
Recommended minimum contact load 1 mA

Time functions and related connection diagrams (Function diagrams: refer to page 130)

The functions are selectable by rotary switch



LED function table:

LED	Relay	Time run
OFF	OFF	NO
Continuous ON	ON	NO
Short blinking	OFF	YES
Long blinking	ON	YES

Time data

7 partial time ranges, t_{max} (rotary switch) 0.6, 6, 60 s / 6, 60 min / 6, 60 h
 Fine adjustment range (rotary knob) $t_{min} \dots t_{max}$: 0.5 ... 6
 Time range tolerance t_{min} : -5 % ... +0 % / t_{max} : -0 % ... +5 %
 Repetition accuracy ± 0.1 % or DC: 2 ms / AC: 10 ms
 Response time, power on, on A1 ≤ 45 ms
 Min. trigger pulse on B1 20 ms (AC / DC)
 Reset time B1 (AC/DC) ≤ 30 ms
 Voltage failure buffering (50 / 60 Hz) ≥ 20 ms

Output

Type MOS FET
 Rated operational current (Fig. 1) 4 A
 Max. inrush current (10 μ s) 40 A
 Max. switching voltage 30 V
 Leakage current $< 10 \mu$ A

Power supply- and control input

Nominal voltage (UC = AC / DC) **UC 24-240 V (UC = AC / DC)**
 Operating voltage range UC 19 ... 250 V
 Power consumption approx. 1 W
 Frequency range 15 ... 60 Hz
 Allowed DC residual current into B1 ≤ 0.5 mA
 AC Neon lamp residual current into B1 ≤ 10 mA
 Trigger threshold voltage on B1, AC / DC 15 / 17 V

Insulation

Test voltage between output and control input 2.5 kVrms 1 minute

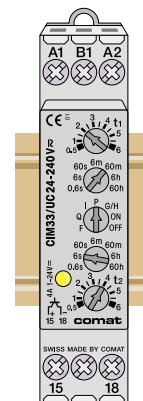
General Specifications

Ambient temperature storage / operation -40 ... 85 °C / -40 ... 60 °C (Railway: -70 °C)
 Conductor cross section Stranded wire 2.5 mm², 2 x 1.5 mm²
 Ingress protection degree IP 20
 Max. Screw torque 0.4 Nm
 Housing material / Weight Lexan / 70 g

Standard types

UC (AC/DC), 15...60 Hz
Railway

CIM33/UC24-240V
CIM33R/UC24-240V



Connection diagram

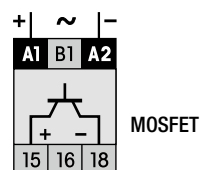
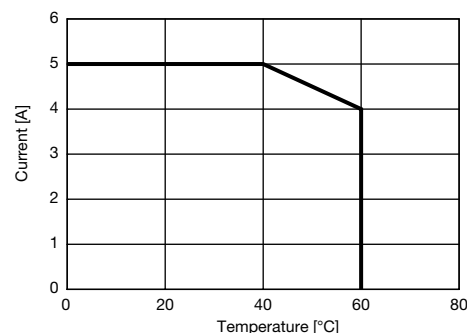
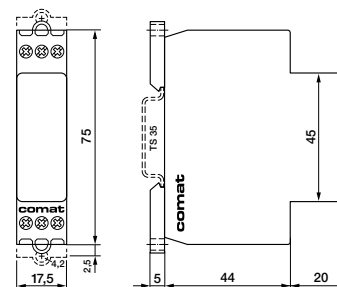


Fig. 1 Output derating curve



Dimensions [mm]



Technical approvals, conformities

EN 50155; EN 60730



CM3

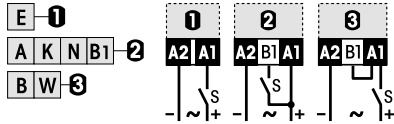
Time relay with two mechanical changeover output contacts 7 time functions, ON-OFF function, 50 ms ... 60 h DIN Rail mounting according to DIN 43 880

Type: CM3/... V R

Multifunction time relay, 7 time functions, time ranges: 50 ms ... 60 h, multifunction LED state indicator, ON / OFF switching function for maintenance, emergency, etc., suitable for railway applications

Maximum contact load	5 A / 250 V AC-1 150 W DC-1
Recommended minimum contact load	10 mA / 10 V

Time functions and related connection diagrams (Function diagrams: refer to page 130)
The functions are selectable by rotary switch



LED function table:

LED	Relay	Time run
OFF	OFF	NO
Continuous ON	ON	NO
Short blinking	OFF	YES
Long blinking	ON	YES

Time data

7 partial time ranges, t_{max} (rotary switch)	0.6, 6, 60 s / 6, 60 min / 6, 60 h
Fine adjustment range (rotary knob)	$t_{min} \dots t_{max}$, 0.5 ... 6
Time range tolerance	t_{min} : -5 % ... +0 % / t_{max} : -0 % ... +5 %
Repetition accuracy	± 0.1 % or DC: 2 ms / AC: 10 ms
Response time, power on, on A1	≤ 25 ms
Min. trigger pulse on B1	35 ms (AC / DC)
Reset time B1 (AC/DC)	≤ 40 ms
Voltage failure buffering	≥ 15 ms

Contacts

Type	2 CO, micro disconnection
Material	AgNi
Rated operational current	5 A
Max. inrush current	25 A
Max. switching voltage AC-1	250 V
Max. AC load AC-1 (Fig.1)	1250 VA
Max. DC load DC-1, 30 V / 250 V (Fig.2)	150 W / 75 W

Power supply and control input

	DC 12-24 V	DC 24-48 V / AC 24-240 V
Nominal voltage	DC 12-24 V	DC 24-48 V / AC 24-240 V
Operating voltage range	9.6 ... 28.8 V	DC 19 ... 60 V AC 19 ... 250 V
Power consumption	approx. 1.3 W	approx. 1.3 W
Frequency range	-	45 ... 63 Hz
Control current into B1	≤ 13.8 mA	≤ 6 mA
Allowed residual current into B1	≤ 4.5 mA	≤ 1.5 mA
Trigger threshold voltage on B1	5.8 ... 6.5 V	DC 13 ... 18 V AC 11 ... 15 V
Inrush current B1, $\tau = 0.4$ ms	≤ 2.6 A	≤ 2.6 A

Insulation

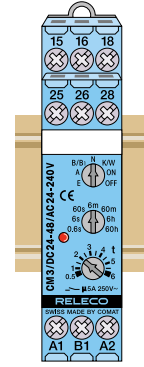
Test voltage open contact	1 kVrms 1 minute
Test voltage between poles	2.5 kVrms 1 minute
Test voltage between contacts and control input	2.5 kVrms 1 minute

General Specifications

Ambient temperature storage / operation	-40 ... 80 °C / -25 ... 60 °C
Mechanical life of contacts	15 x 10 ⁶ operations
Conductor cross section	Stranded wire 2.5 mm ² , 2 x 1.5 mm ²
Ingress protection degree	IP 20
Max. Screw torque	0.4 Nm
Housing material / weight	Lexan / 72 g

Standard types

DC	CM3/DC12-24V R
DC, AC 45...63 Hz	CM3/DC24 -48V/AC24-240V R



Connection diagram

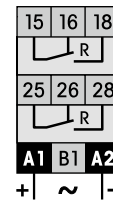


Fig.1 AC voltage endurance

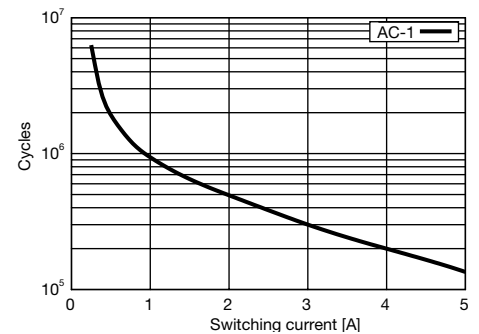
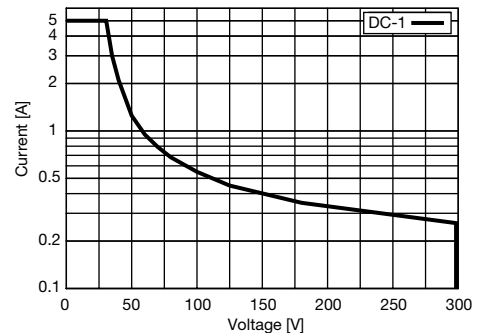
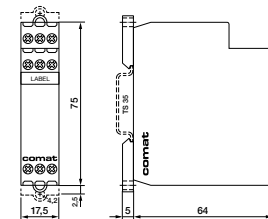


Fig. 2 DC load limit curve



Dimensions [mm]



Technical approvals, conformities



EN 50155, EN 60730

CRV2

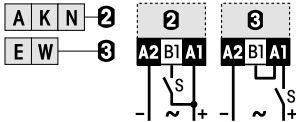
Multifunction time relay with mechanical changeover output contact
5 time functions, 50 ms ... 60 h
DIN Rail mounting according to DIN 43 880

Type: CRV2/... V R

Multifunction time relay, 1 changeover contact, UC 24 V, AC 230 V operating voltages, 5 time functions, LED state indicator for output and control input

Maximum contact load 6 A / 250 V AC-1 180 W DC-1
Recommended minimum contact load 10 mA / 10 V

Time functions and related connection diagrams (Function diagrams: refer to page 130)



Time data

7 partial time ranges, t_{max} (rotary switch)	0.6, 6, 60 s / 6, 60 min / 6, 60 h
Fine adjustment range (rotary knob)	$t_{min} \dots t_{max}$, 5 ... 60
Time range tolerance	t_{min} : -30 % ... +0 % / t_{max} : -0 % ... +30 %
Repetition accuracy	± 0.3 % or DC: 15 ms / AC: 25 ms
Response time, power on, on A1	≤ 30 ms
Min. trigger pulse on B1	35 ms (AC / DC)
Reset time B1 (AC/DC)	≤ 100 ms
Voltage failure buffering	≥ 10 ms

Contacts

Type	1 CO, micro disconnection
Material	AgNi
Rated operational current	6 A
Max. inrush current (10 ms)	30 A
Max. switching voltage AC-1	250 V
Max. AC load AC-1 (Fig.1)	1500 VA
Max. DC load DC-1, 30 V / 250 V (Fig.2)	180 W / 75 W

Power supply and control input

	UC 24 V	AC 230 V
Nominal voltage	20 ... 28 V	195 ... 265 V
Operating voltage range	≤ 1.2 W	≤ 1.4 W
Power consumption	50 / 60 Hz	50 / 60 Hz
Frequency range	-	2 A, $\tau = 50 \mu s$
Inrush current A1	2.5 mA	3.6 mA
Input current into B1 typ.	≤ 1 mA	≤ 1 mA
Allowed residual current into B1	15 V / 17 V	100 V
Trigger threshold voltage on B1 AC / DC typ.		

Insulation

Test voltage open contact	1 kVrms 1 minute
Test voltage between contacts and control input	2 kVrms 1 minute

General Specifications

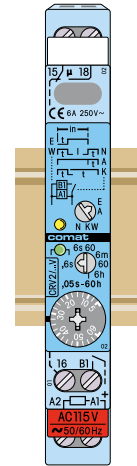
Ambient temperature storage /operation	-40 ... 80 °C / -25 ...55 °C
Mechanical life of contacts	30 x 10 ⁶ operations
Conductor cross section	Stranded wire 2.5 mm ² , 2 x 1 mm ²
Ingress Protection degree	Housing: IP 40, terminals: IP 20
Max. Screw torque	0.4 Nm
Housing material / Weight	Lexan / 60 g

Standard types

UC, 50 / 60 Hz	CRV2/UC24V R
AC, 50 / 60 Hz	CRV2/AC230V R

Accessories

Marking strip:	Large	BS-13G
	Small	BS-13K



Connection diagram

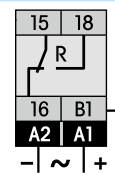


Fig.1 AC electrical endurance

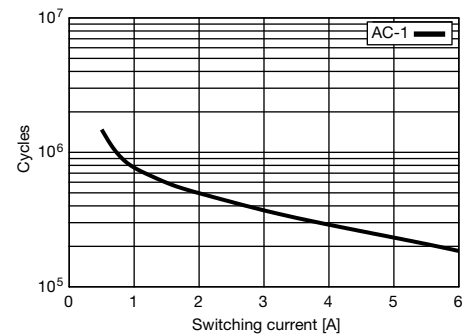
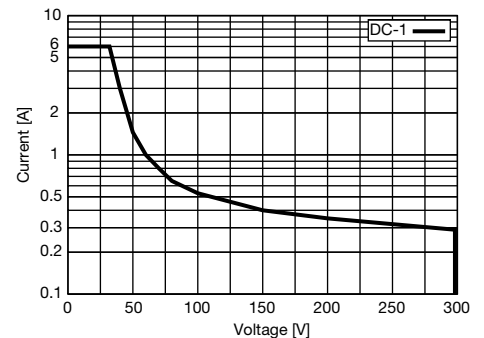
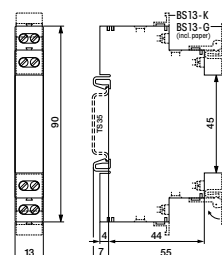


Fig. 2 DC load limit curve



Dimensions [mm]



Technical approvals, conformities



CRV3

Time relay with 2 time elapses, mechanical changeover output contact 2 time functions, 2 x 50 ms ... 60 h DIN Rail mounting according to DIN 43 880

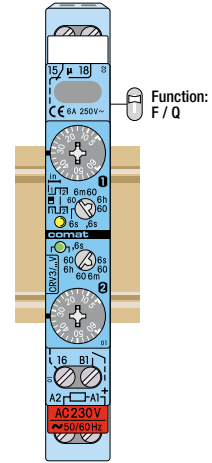
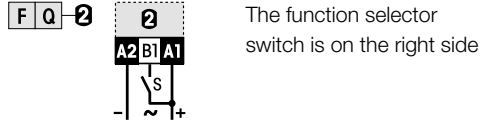


Type: CRV3/... V R

Time relay with 7 time ranges, 1 changeover contact, UC 24 V, AC 230 V operating voltages, 2 time functions, 2 x 50 ms ... 60 h, LED state indicator for output and control input

Maximum contact load	6 A / 250 V AC-1 180 W DC-1
Recommended minimum contact load	10 mA / 10 V

Time functions and related connection diagrams (Function diagrams: refer to page 130)



Time data

7 partial time ranges, t_{max} (rotary switch)	0.6, 6, 60 s / 6, 60 min / 6, 60 h
Fine adjustment range (rotary knob)	$t_{min} \dots t_{max}$, 5 ... 60
Time range tolerance	t_{min} : -30 % ... +0 % / t_{max} : -0 % ... +30 %
Repetition accuracy	± 0.3 % or DC: 15 ms / AC: 25 ms
Response time, power on, on A1	≤ 100 ms
Min. trigger pulse on B1	35 ms (AC / DC)
Reset time B1 (AC/DC)	≤ 60 ms
Voltage failure buffering	≥ 20 ms

Contacts

Type	1 CO, micro disconnection
Material	AgNi
Rated operational current	6 A
Max. inrush current (10 ms)	30 A
Max. switching voltage AC-1	250 V
Max. AC load AC-1 (Fig.1)	1500 VA
Max. DC load DC-1, 30 V / 250 V (Fig.2)	180 W / 75 W

Power supply and control input

	UC 24 V	AC 230 V
Nominal voltage	19 ... 27.6 V	195 ... 265 V
Operating voltage range	≤ 1.2 W	≤ 1.4 W
Power consumption	50 / 60 Hz	50 / 60 Hz
Frequency range	-	2 A, $\tau = 50 \mu s$
Inrush current A1	5.8 mA	3.6 mA
Input current into B1 typ.	≤ 2 mA	≤ 1 mA
Allowed residual current into B1	12 V / 15 V	100 V
Trigger threshold voltage on B1, AC / DC		

Insulation

Test voltage open contact	1 kVrms 1 minute
Test voltage between contacts and control input	2 kVrms 1 minute

General Specifications

Ambient temperature storage /operation	-40 ... 80 °C / -25 ... 55 °C
Mechanical life of contacts	30 x 10 ⁶ operations
Conductor cross section	Stranded wire 2.5 mm ² , 2 x 1 mm ²
Ingress Protection degree	Housing: IP 40, terminals: IP 20
Max. Screw torque	0.4 Nm
Housing material / Weight	Lexan / 60 g

Standard types

UC, 50 / 60 Hz	CRV3/UC24V R
AC, 50 / 60 Hz	CRV3/AC230V R

Accessories

Marking strip:	Large	BS-13G
	Small	BS-13K

Connection diagram

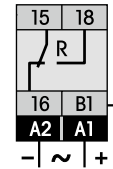


Fig.1 AC electrical endurance

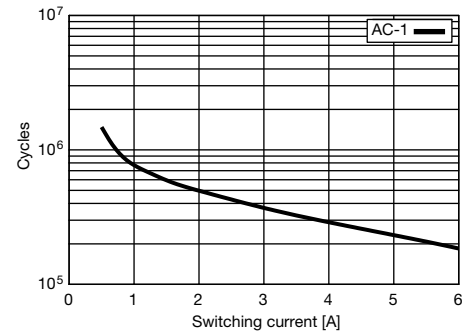
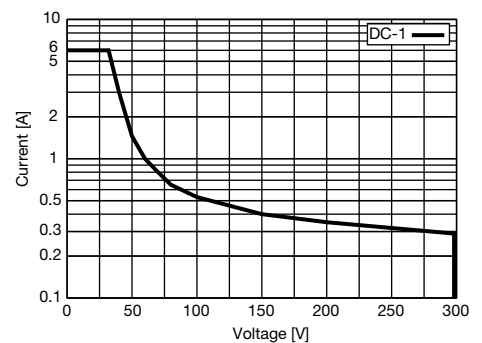
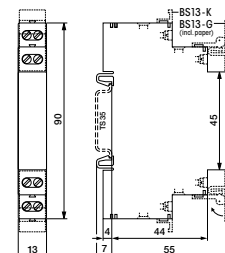


Fig. 2 DC load limit curve



Dimensions [mm]



Technical approvals, conformities



CSV2

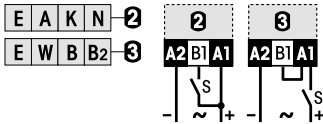
Multifunction time relay, internal or external potentiometer operation, DC solid state output, 8 ms ... 10 h, DIN Rail mounting according to DIN 43 880

Type: CSV2/DC24V R

Multifunction time relay
 DC solid state output
 DC 24 V operating voltage
 Option for external fine adjustment time range potentiometer
 LED state indicators for output and control input

Maximum output load 1.5 A / 30 V

Time functions and related connection diagrams (Function diagrams: refer to page 130)



Time data

7 partial time ranges, t_{max} (rotary switch)	0.1 , 1, 10 s / 1, 10 min / 1, 10 h
Fine adjustment range (rotary knob)	$t_{min} \dots t_{max}$, 0.8 ... 10
Time range tolerance	t_{min} : -30 % ... +0 % / t_{max} : -0 % ... +30 %
Repetition accuracy	± 0.3 % or 10 ms
Response time, power on, on A1	≤ 10 ms
Min. trigger pulse on B1	10 ms
Reset time B1 (AC/DC)	≤ 10 ms
Voltage failure buffering	≥ 10 ms

Output

Type: Power MOS FET	High side switch
Rated operational current	1.5 A
Max. inrush current (100 ms)	4 A
Max. switching voltage	30 V
Leakage current	≤ 100 µA
Inductive switch-off voltage protection	Free wheeling diode + 33 Ω

Power supply and control input

Nominal voltage	DC 24 V
Operating voltage range	15 ... 30 V
Power consumption	≤ 0.7 W
Control current into B1	≤ 9 mA
Allowed residual current into B1	≤ 1.5 mA
Trigger threshold voltage on B1 typ.	9 V

General Specifications

Ambient temperature storage /operation	-40 ... 80 °C / -25 ... 55 °C
Ambient temperature, mounted side by side	-25 ... 45 °C
Conductor cross section	Stranded wire 2.5 mm ² , 2 x 1 mm ²
Ingress Protection degree	Housing: IP 40, terminals: IP 20
Max. Screw torque	0.4 Nm
Housing material / Weight	Lexan / 50 g

Standard types

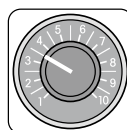
CSV2/DC24V R

Accessories

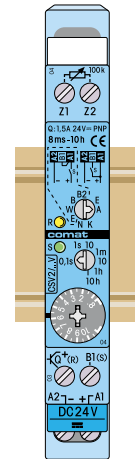
External potentiometer 100k
 (Panel mounting + scale):
 Marking strip:

Large
 Small

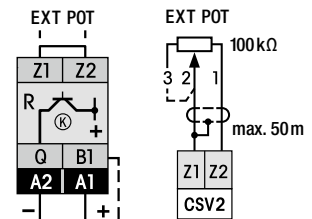
SP-01/100k
BS-13G
BS-13K



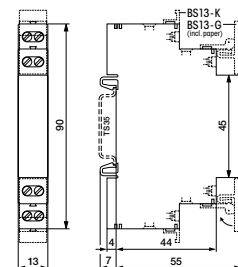
Option:
 External
 Pot.-Meter
 SP-01/100k



Connection diagram



Dimensions [mm]



Technical approvals, conformities



AM2

Time relay with 1 changeover power contact 4 time functions, 0.5 s ... 60 minutes DIN Rail mounting according to DIN 43 880

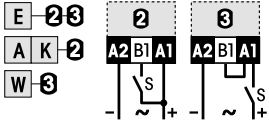


Type: AM2/ ... V

Multifunction time relay, 1 CO contacts, 4 time functions and ON function, time ranges: 0.5 s ... 60 minutes, LED state indicator for output, also suitable for panel mounting 2 x M4

Maximum contact load	10 A 250 V AC-1	6 A 25 V DC-1
Recommended minimum contact load	100 mA / 12 V	

Time functions and related connection diagrams (Function diagrams: refer to page 130)



Time data

4 partial time ranges, t_{max} (DIP switch)	6, 60 s / 6, 60 min
Fine adjustment range (rotary knob)	$t_{min} \dots t_{max}$, 0.5 ... 6
Time range tolerance	t_{min} : -30 % ... +0 % / t_{max} : -0 % ... +30 %
Repetition accuracy	± 0.2 % or 20 ms
Response time, power on, on A1	≤ 50 ms
Min. trigger pulse width on input B1	100 ms (AC / DC)
Reset time B1 (AC/DC)	≤ 90 ms
Voltage failure buffering	≥ 5 ms

Contacts

Type	Single contact, micro disconnection	
Material	AgSnO ₂	
Rated operational current	10 A	
Max. inrush current (10ms)	16 A	
Max. switching voltage AC-1	250 V	
Max. AC load AC-1 (Fig. 1)	2500 VA AC-1	
Max. DC load DC-1 24 V / 220 V (Fig. 2)	150 W / 70 W	

Power supply- and control input

	UC 24 - 60 V	AC 220 - 240 V
Nominal voltage (UC = AC / DC)	20 ... 75 V	180 ... 265 V
Operating voltage range	20 ... 75 V	180 ... 265 V
Power consumption	≤ 1.5 W	≤ 1.5 W
Frequency range	40 ... 60 Hz	40 ... 60 Hz
Input current into B1 typ.	≤ 25 mA (40 mA)	≤ 10 mA (15 mA)
Allowed residual current into B1	≤ 1.5 mA	≤ 1 mA
Trigger threshold voltage on B1 typ AC / DC	14 / 17 V	140 V

¹⁾ B1 can be used as power supply and control input, without A1. For func. E and W. The current is then higher, values in brackets.

Insulation

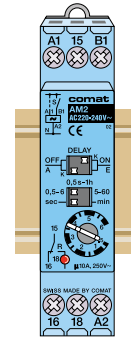
Test voltage open contact	1 kVrms 1 minute
Test voltage between contacts and control input	2 kVrms 1 minute

General Specifications

Ambient temperature storage /operation	-40 ... 85 °C / -40 ...60 °C
Mechanical life of contact	20 x 10 ⁶ operations
Conductor cross section	Stranded wire 2.5 mm ² , 2 x 1.5 mm ²
Ingress protection degree	IP 20
Max. Screw torque	0.4 Nm
Housing material / Weight	Lexan / 70 g

Standard types

UC (AC/DC) 40...60 Hz	AM2/UC24-60V R
	AM2/AC220-240V R



Connection diagram

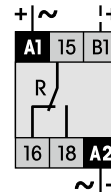


Fig.1 AC voltage endurance

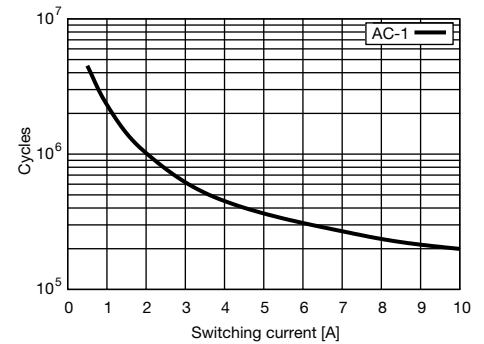
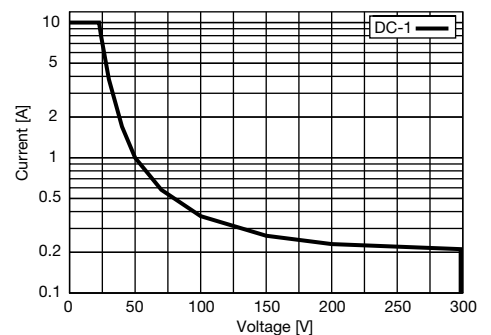
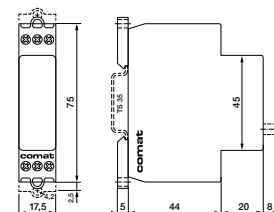


Fig. 2 DC load limit curve



Dimensions [mm]



Technical approvals, conformities



EN 60947

AM3

Time relay with 2 changeover output contacts, one of them selectable as instantaneous contact 4 time functions, 0.5 s ... 60 minutes DIN Rail mounting according to DIN 43 880

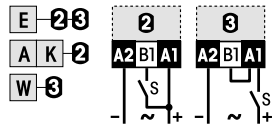


Type: AM3/ ... V

multifunction time relay , 2 CO contacts, 1 contact selectable as instantaneously or delayed, 4 time functions and ON function, time ranges: 0.5 s ... 60 minutes, LED state indicators for output and control input

Maximum contact load 10 A / 250 V AC-1 10 A / 30 V DC-1
Recommended minimum contact load 100 mA / 5 V

Time functions and related connection diagrams (Function diagrams: refer to page 130)



Selection of the operation mode of the second CO contact: DIP-switch:
 R2 = S: instantaneously, R2 = R: Delayed.

Time data

4 partial time ranges, t_{max} (DIP switch)	6, 60 s / 6, 60 min
Fine adjustment range (rotary knob)	$t_{min} \dots t_{max}$, 0.5 ... 6
Time range tolerance	t_{min} : -30 % ... +0 % / t_{max} : -0 % ... +30 %
Repetition accuracy	± 0.25 % or 20 ms
Response time, power on, on A1	≤ 50 ms
Min. trigger pulse on B1	100 ms (AC / DC)
Reset time B1 (AC/DC)	≤ 90 ms
Voltage failure buffering	≥ 3 ms

Contacts

Type / Material	2 CO, micro disconnection / AgNi
Rated operational current	10 A
Sum current of both contacts	12 A @ $T_a = 45 \text{ °C}$, 100 % duty cycle
Max. inrush current (20 ms)	16 A
Max. switching voltage AC-1	250 V
Max. AC load AC-1 (Fig.1)	2500 VA
Max. DC load DC-1, 30 V / 100 V (Fig. 2)	300 W / 60 W

Power supply- and control input

	UC 24 - 60 V	AC 220 - 240 V
Nominal voltage (UC = AC / DC)	19 ... 75 V	195 ... 265 V
Operating voltage range	19 ... 75 V	195 ... 265 V
Power consumption	≤ 1.8 W	≤ 1.8 W
Frequency range	40 ... 400 Hz	40 ... 60 Hz
Input current into B1 typ.	≤ 20 mA (50 mA)	≤ 5 mA (15 mA)
Allowed residual current into B1	≤ 1.5 mA	≤ 1 mA
Trigger threshold voltage on B1 typ AC / DC	14 / 17 V	140 V

Insulation

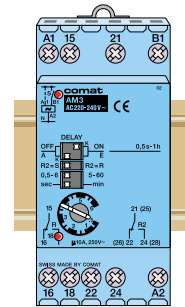
Test voltage open contact	1 kVrms 1 minute
Test voltage between contacts and control input	2 kVrms 1 minute

General Specifications

Ambient temperature storage /operation	-40 ... 80 °C / -40 ... 50 °C
Mechanical life of contact	10 ⁷ operations
Conductor cross section	Stranded wire 2.5 mm ² , 2 x 1.5 mm ²
Ingress protection degree	IP 20
Max. Screw torque	0.4 Nm
Housing material / Weight	Lexan / 110 g

Standard types

UC (AC/DC) 40...400 Hz	AM3/UC24-60V R
AC 50 / 60 Hz	AM3/AC220 -240V R



Connection diagram

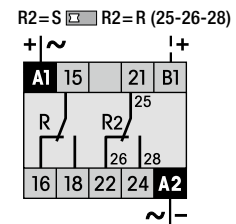


Fig.1 Contact endurance

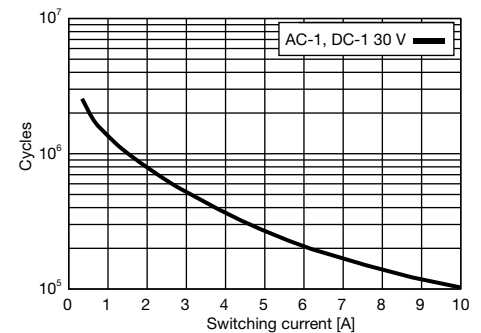
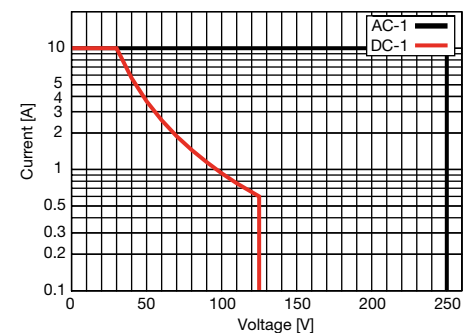
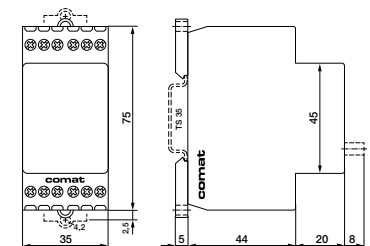


Fig. 2 Load limit curve



Dimensions [mm]



Technical approvals, conformities



CNR1

**Running without auxiliary voltage, mechanical changeover output contact, 2 time functions, 0.1 s ... 12 minutes
DIN Rail mounting according to DIN 43 880**

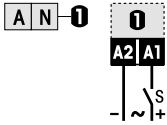


Type: CNR1/... V R

time relay, 1 changeover contact, 250 V, UC 24 ... 60 V, UC 110 ... 240 V operation voltages, 2 time functions, time ranges: 0.1 s ... 20 minutes, LED for supply voltage state indication, also suitable for panel mounting 2 x M4

Maximum contact load 5 A / 250 V AC-1 5 A / 30 V DC-1
Recommended minimum contact load 1 mA / 0.1 V

Time functions and related connection diagrams (Function diagrams: refer to page 130)



Time data

4 partial time ranges, t_{max} (DIP switch)	1.2 s / 12 s / 120 s / 12 minutes
Fine adjustment range (rotary knob)	$t_{min} \dots t_{max}$, 1 ... 12
Time range tolerance	t_{min} : -25 % ... +5 % / t_{max} : -5 % ... +25 %
Repetition accuracy	± 1 %
Min. start impulse on A1	≥ 150 ms
Reset time	≥ 100 ms
Voltage failure buffering	5 ... 10 ms

Contacts

Type	1 CO, micro disconnection
Material	Gold flash over silver alloy
Rated operational current	5 A
Max. switching voltage AC-1	250 V
Max. switching voltage DC-1	125 V
Max. AC load AC-1 (Fig.1)	1250 VA
Max. DC load 30 V / 125 V (Fig.2)	150 W / 25 W

Control input (UC = AC / DC)

	UC 24 - 60 V	UC 110 - 240 V
Nominal voltage (A1)	20 ... 75	88 ... 265
Operating voltage range [V]	20 ... 75	88 ... 265
Input current [mA]	3 ... 15	2 ... 5
Inrush current (100 ms) [mA]	150	50
Frequency [Hz]	50	50
Threshold voltage AC / DC [V]	≥ 14 / ≥ 18	≥ 65 / ≥ 85

Insulation

Test voltage open contact	1 kVrms 1 minute
Test voltage between contacts and control input	2 kVrms 1 minute

General Specifications

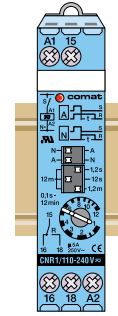
Ambient temperature storage / operation	-40 ... 85 °C / -25 ... 60 °C
Mechanical life of contacts	> 50 x 10 ⁶ operations
Ingress protection degree	IP 20
Housing material / Weight	Lexan / 60 g

Standard types

UC (AC/DC) 50 Hz	CNR1/UC24-60V R CNR1/UC110-240V R
------------------	--

Accessories

Label plate: (replacement)	BZS-DIN 17.5
----------------------------	---------------------



Connection diagram

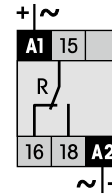


Fig.1 Contact endurance

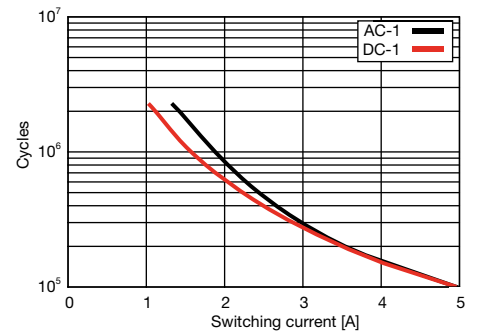
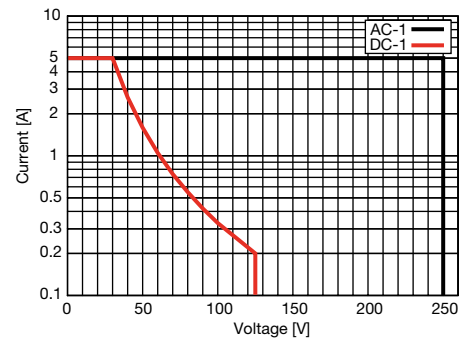
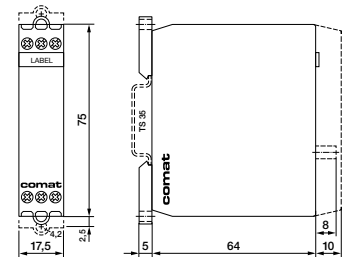


Fig. 2 Load limit curve



Dimensions [mm]



Technical approvals, conformities



CPF11

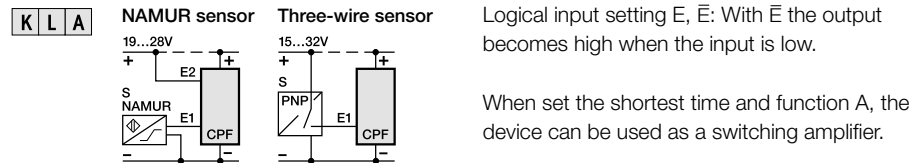
Versatile time relay with DC solid state output, 3 time functions for pulse shaping applications, 5 ... 600 ms DIN Rail mounting according to DIN 43 880

Type: CPF11/DC24V R

Pulse shaper. DC solid state output, short circuit proof. DC 24 V operating voltage. Very suitable as PLC-interface for contact- and sensor signals (NAMUR, 3 – wire) but also for inductive- or lamp loads. Selectable free wheeling diode built in. Adjustable input filter time. LED state indicators for output and control input. Also suitable for panel mounting 2 x M4

Maximum output load **2 A / 32 V**

Time functions and related connection diagrams (Function diagrams: refer to page 130)



Time data

2 partial time ranges, t_{max} (DIP switch)	60, 600 ms
Fine adjustment range (rotary knob)	$t_{min} \dots t_{max}$, 0.5 ... 6
Time range tolerance	t_{min} : -30 % ... +0 % / t_{max} : -0 % ... +30 %
Repetition accuracy	$\pm 0.5 \%$ or 2 ms
Min. trigger pulse width on input B1	1 ms / 5 ms selectable
Reset time B1	$\leq 5 \text{ ms} / \leq 25 \text{ ms}$

Output

Type: Power MOS FET	High side switch
Rated operational current, $T_a = 60 \text{ }^\circ\text{C}$	0.7 A 100% duty cycle
Rated operational current, $T_a = 50 \text{ }^\circ\text{C}$	0.8 A 100% duty cycle
Operational pulse current	2 A when $t_{ON} \leq t_{OFF}$, $t_{ON} \leq 5 \text{ s}$
Short circuit current	$\leq 7 \text{ A}$
Max. switching voltage	32 V
Leakage current (without free wheeling diode)	$\leq 1 \mu\text{A}$
Inductive switch-off voltage protection	Selectable free wheeling diode

Power supply and control input

Nominal voltage	DC 24 V
Operating voltage range normal operation	15 ... 32 V
Operating voltage range NAMUR operation (DIN 19234)	19 ... 28 V
Power consumption	$\leq 0.6 \text{ W}$
Trigger threshold voltage E1	$\leq 10 \text{ V}$
Trigger threshold voltage E2	$\leq 15 \text{ V}$

General Specifications

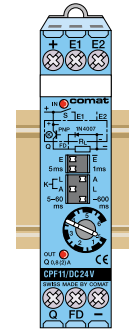
Ambient temperature storage / operation	-40 ... 80 $^\circ\text{C}$ / -25 ... 60 $^\circ\text{C}$
Conductor cross section	Stranded wire 2.5 mm ² , 2 x 1 mm ²
Ingress Protection degree	Housing: IP 40, terminals: IP 20
Max. Screw torque	0.4 Nm
Housing material / Weight	Lexan / 60 g

Standard types

CPF11/DC24V R

Accessories

Label plate: (replacement) **BZS-DIN 17.5**



Connection diagram

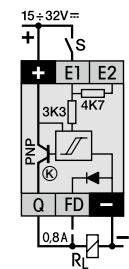


Fig. 1 Derating Curve

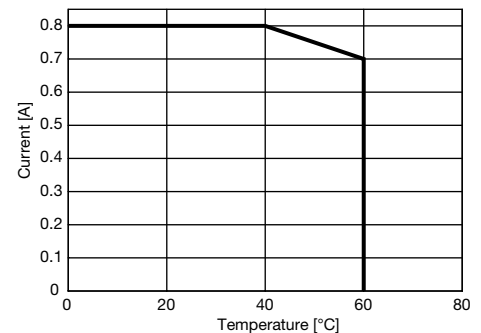
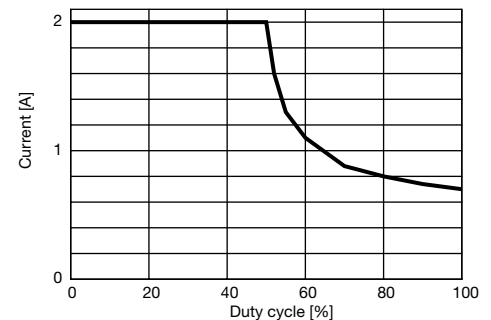
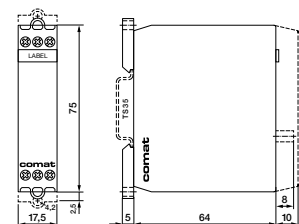


Fig. 2 Current vs. duty cycle



Dimensions [mm]



Technical approvals, conformities



CY1

Star - Delta starting time relay, 0.5 ... 60 s
DIN Rail mounting according to DIN 43 880

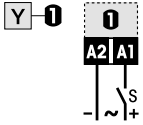


Type: CY1/... V R

star-Delta starting time relay, adjustable star starting time until 60 s, 2 switch over delay times, 50 ms, 100 ms, LED state indicators for control input and delta-run, also suitable for panel mounting 2 x M4

Maximum contact load 6 A / 250 V AC-1 180 W DC-1
Recommended minimum contact load 10 mA / 10 V

Time functions and related connection diagrams (Function diagrams: refer to page 130)



Time data

2 partial time ranges, t_{max} (DIP switch)	0.5 ... 6 s / 5 ... 60 s
Fine adjustment range (rotary knob)	$t_{min} ... t_{max}$, 0.5 ... 6
Time range tolerance	t_{min} : -20 % ... +0 % / t_{max} : -0 % ... +20 %
Repetition accuracy	± 0.1 %
Switch over delay time (DIP switch)	50 ms / 100 ms (-0 / + 40 %)
Voltage failure buffering	≥ 25 ms

Contacts

Type	2 CO, micro disconnection
Material	AgNi
Rated operational current	6 A
Max. inrush current (10 ms)	30 A
Max. switching voltage AC-1	250 V
Max. AC load AC-1 (Fig.1)	1500 VA
Max. DC load DC-1, 30 V / 250 V (Fig.2)	180 W / 75 W

Control input

	UC 24-60 V	UC 110-240 V
Nominal voltage	20 ... 75 V	90 ... 265 V
Operating voltage range	20 ... 75 V	90 ... 265 V
Power consumption	≤ 1 W	≤ 1 W
Frequency range	50 Hz / 60 Hz	50 Hz / 60 Hz
Threshold voltage AC / DC	≤ 17 V / ≤ 19	≤ 60 V / ≤ 85 V
Max. Inrush current	1.5 A / 100 μs	0.6 A / 100 μs

Insulation

Test voltage open contact	1 kVrms 1 minute
Test voltage between contacts and control input	2 kVrms 1 minute

General Specifications

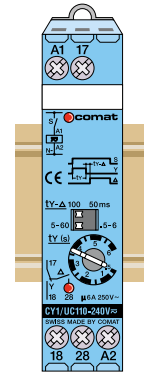
Ambient temperature storage /operation	-40 ... 80 °C / -25 ... 60 °C
Mechanical life of contacts	30 x 10 ⁶ operations
Conductor cross section	Stranded wire 2.5 mm ² , 2 x 1.5 mm ²
Ingress protection degree	IP 20
Max. Screw torque	0.4 Nm
Housing material / Weight	Lexan / 76 g

Standard types

UC 50 Hz /60 HZ	CY1/UC24-60V R
	CY1/UC110-240V R

Accessories

Label plate: (replacement)	BZS-DIN 17.5
----------------------------	--------------



Connection diagram

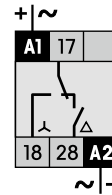


Fig.1 AC electrical endurance

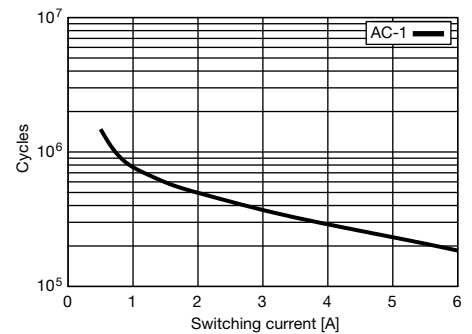
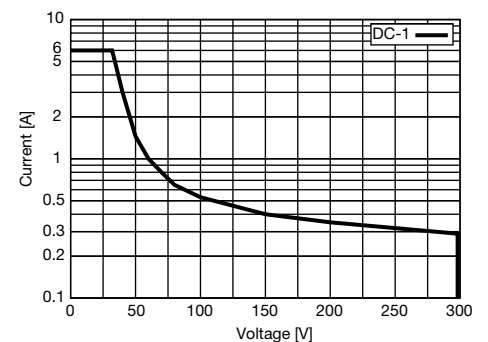
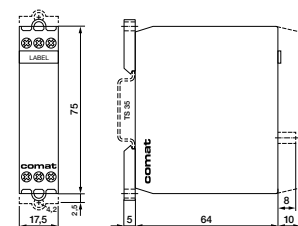


Fig. 2 DC load limit curve



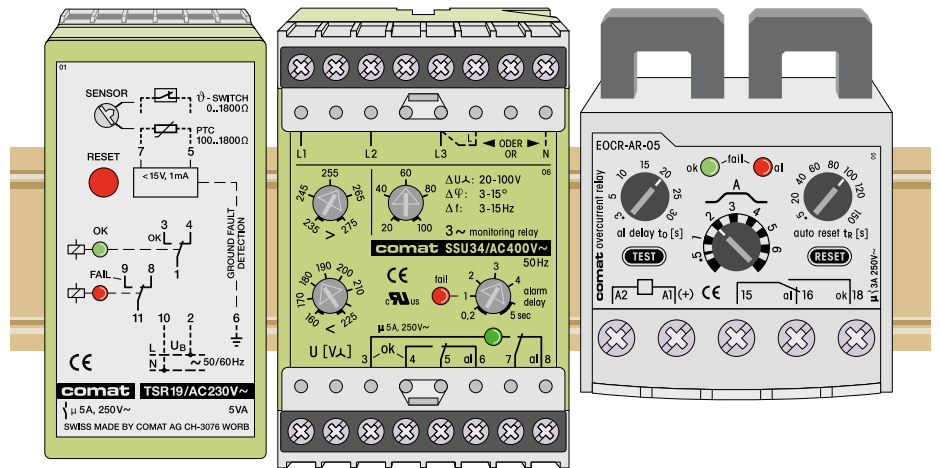
Dimensions [mm]



Technical approvals, conformities

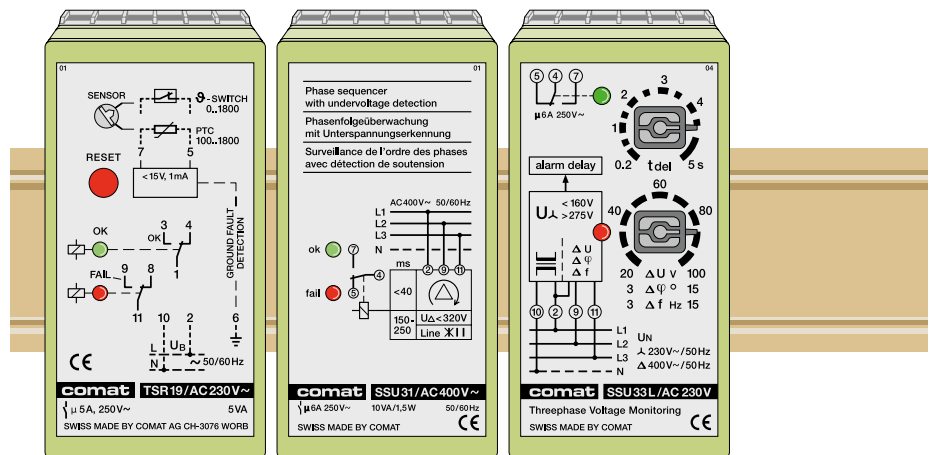


Monitoring Relays



3.1 Plug-in Monitoring Relays

Plug-in Monitoring Relays



Application	Types	Monitoring	Monitoring ratings	Output contacts	Design
3.1 Plug-in Monitoring Relays					
Thermo protection	TSR19		Th.sens. 0 ... 1800 Ω	2 CO	11 pin
Phase sequence monitoring	SSU31		Δ 208 V, 400 V	1 CO	11 pin
3 Phase monitoring	SSU33L		∟ 230 V, Δ 400 V	1 CO	11 pin

TSR19

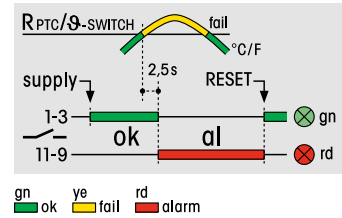
11 pin plug-in thermal motor protection relay according to IEC 67-I-18a



Type: TSR19/...V

Plug-in monitoring relay for temperature of coils of motors, transformers etc.
1 CO contact for OK state, 1 CO contact for alarm state.

Monitoring function



The TSR19 monitors the temperature of motor coils, generators and transformers. It detects the temperature of the windings by the change of the PTC thermistors resistances ① or by the state of the thermo switches ②. The circuit detects a sensor line interruption or a ground fault of the sensor lines.

Reset after failure detection: Press reset button or interrupt the supply voltage for > 200 ms.

Measuring circuit data

Sensor resistance, OK range	100 ... 1800 Ω
Thermo switch, OK range	0 ... 1800 Ω
Fail ranges	≤ 50 Ω, ≥ 2250 Ω, ≤ 1 kΩ ground fault
Max. sensor conductor resistance	20 Ω
Sensor supply voltage, idle state	15 V @ R _{Sens} = ∞

Time data

Constant alarm delay time	2.5 s ± 20 %
Voltage failure buffering	100 ms

Contacts

Type / material	2 CO, micro disconnection / Ag Ni
Rated operational current	5 A
Inrush current (10 ms)	30 A
Max. switching voltage AC-1, DC-1	250 V
Max. AC load AC-1 (Fig 1.)	1250 VA
Max. DC load 30 V / 250 V (Fig 2.)	120 W / 50 W
Recommended min. contact load	10 mA / 12 V

Power supply

Nominal voltage (UC = AC / DC)	UC 24 – 48 V	AC 230 V
Operating voltage range	UC 19 ... 60 V	AC 190 ... 250 V
Power consumption	1.5 W	1.5 W
Frequency range	50 / 60 Hz	50 / 60 Hz

Insulation

Test voltage between contacts and other circuits	2 kVrms 1 minute
Test voltage between Power supply inputs and other circuits	2 kVrms 1 minute

General specifications

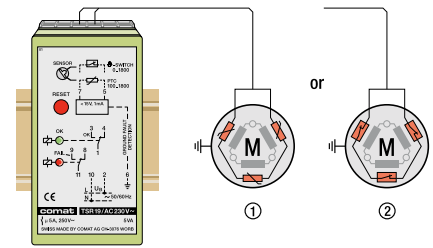
Ambient temperature storage / operation	-40 ... 85 °C / -10 ... 60 °C
Mechanical life of contacts	≥ 30 x 10 ⁶
Ingress protection degree	IP 40 when plugged in
Housing material	Lexan, alu front plate
Weight	210 g

Standard types

AC 230 (50/60Hz)	TSR19/AC230V
UC 24-48	TSR19/UC24-48V

Accessories

Socket:	S-3B
Retention clip:	HF-24
Front panel mounting set:	FZ-23



Connection diagram

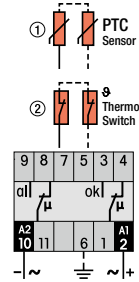


Fig.1 AC voltage endurance

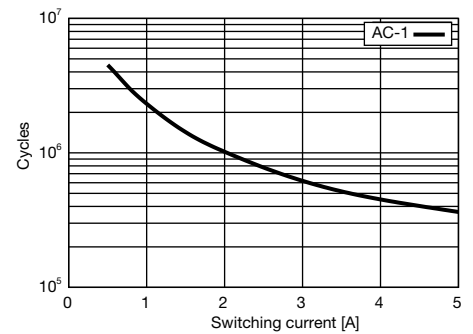
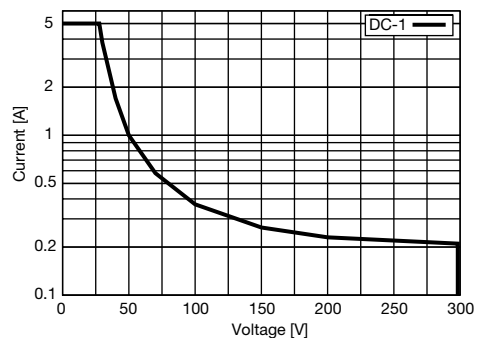
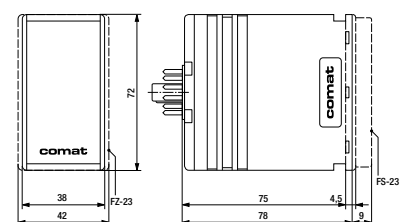


Fig. 2 DC load limit curve



Dimensions [mm]



Technical approvals, conformities

EN 61010; EN 60947



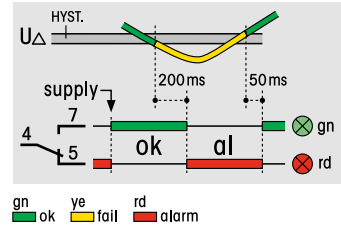
SSU31

11 pin plug-in phase sequence monitoring relay according to IEC 67-I-18a

Type: SSU31/... V

1 change over alarm contact 6 A 250V

Monitoring function



The SSU31 serves as a phase-sequence, three-phase undervoltage and phase failure monitor. The monitoring function helps to ensure the correct rotation direction of pumps, motors and conveyors in mobile devices with connection to different power outlets. The defined undervoltage and phase failure protects against malfunction and damage caused by overheating.

Measuring circuit data

Nominal delta connection mains voltage	208 V	400 V
Under voltage threshold	≤ 166 V ± 5 %	≤ 320 V ± 5 %
Hysteresis	5 V	10 V
Phase sequence	L1-L2-L3	L1-L2-L3
Phase loss	One or several	One or several

Time data

Alarm delay for phase sequence	30 ms / +0 % ... -25 %
Alarm delay for phase loss	150 - 250 ms
Alarm delay for under voltage	150 - 250 ms
Reset time	50 ms

Contacts

Type / Material	1 CO, micro disconnection / AgNi
Rated operational current	6 A
Max. inrush current (10 ms)	30 A
Max. switching voltage	250 V
Max. AC load AC-1 (Fig.1)	1500 VA
Max. DC load DC-1, 30 V / 250 V (Fig.2)	180 W / 75 W
Recommended min. contact load	10 mA / 12 V

Power supply data

Nominal delta connection mains voltage	208 V	400 V
Operating voltage range	176 ... 235 V	340 ... 460 V
Power consumption	1.5 W	1.5 W
Input current	≤ 25 mA	≤ 25 mA
Frequency range	45 ... 65 Hz	45 ... 65 Hz

Insulation

Test voltage between contacts and supply	2 kVrms 1 minute (basic insulation)
--	-------------------------------------

General specifications

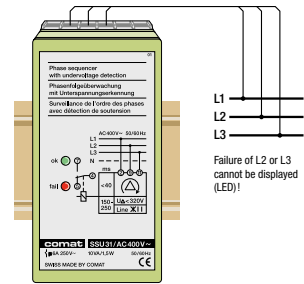
Ambient temperature storage /operation	-40 ... +85 °C / -25 ... +60 °C
Mechanical life of contacts	30 x 10 ⁶ operations
Ingress protection degree	IP 40 when plugged in
Weight	300 g

Standard types

AC 208 50 / 60Hz	SSU31/AC208V
AC 400 50 / 60Hz	SSU31/AC400V

Accessories

Socket:	S-3B
Retention clip:	HF-24
Front panel mounting set:	FZ-23



Connection diagram

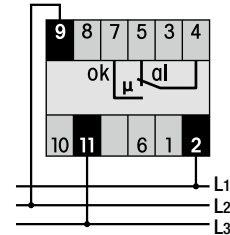


Fig.1 AC voltage endurance

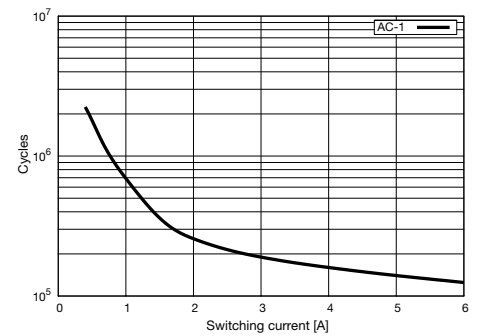
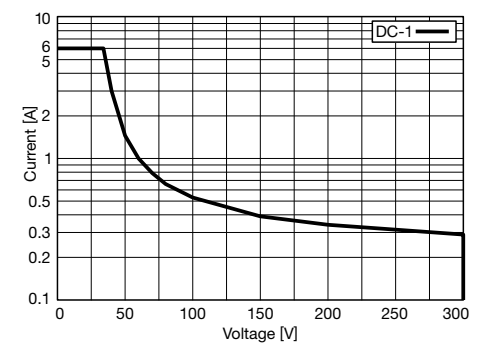
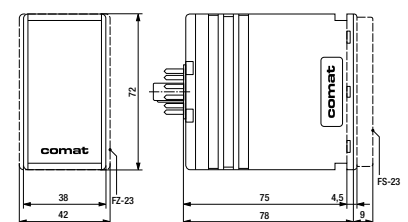


Fig. 2 DC load limit curve



Dimensions [mm]



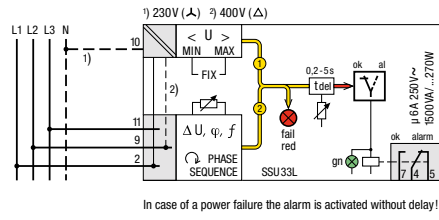
Technical approvals, conformities



Type: SSU33L/... V

1 change over alarm contact 6 A 250 V

Monitoring function



The SSU33 (50Hz) provides comprehensive monitoring of three-phase mains supplies with or without neutral.

The following mains faults are monitored:

Error signal ① U (V_λ, V_Δ):

Exceeding or dropping below the fixed voltage values U_{min}/U_{max} for L1-N or L1-L2 (no differential voltage, phase position or frequency fault).

Error signal ② U, Δφ, Δf:

One or more of the three voltages, phase positions, phase sequence or the mains frequency are diverging from the required value.

Depending on the nature of their occurrence Δ-errors are evaluated cumulatively.

Any error is signalled by the red LED and is reported after expiry of the set alarmdelay time.

In the correct status (ok) the green LED is illuminated (4-5 open, 4-7 closed).

Measuring circuit data

	Type star with N	Type delta
Nominal mains voltage	230 V	400 V
Constant under voltage threshold ± 5 %	L1 – N ≤ 160 V	L1-L2 ≤ 280 V
Constant over voltage threshold ± 5 %	L1 – N ≥ 275 V	L1-L2 ≥ 480 V
Difference voltage adjustment range ¹⁾	20 ... 100 V	20 ... 100 V to N
φ adjustment range ¹⁾	3 ... 15 °	3 ... 15 °
f adjustment range ¹⁾	3 ... 15 Hz	3 ... 15 Hz

¹⁾ adjustment with the same rotary knob

Time data

Alarm delay adjustment range	0.2 ... 5 s
Reset time	50 ms

Contacts

Type / Material	1 CO, micro disconnection / AgNi
Rated operational current	6 A
Max. inrush current (10 ms)	30 A
Max. switching voltage	250 V
Max. AC load AC-1 (Fig.1)	1500 VA
Max. DC load DC-1, 30 V / 250 V (Fig.2)	180 W / 75 W
Recommended min. contact load	10 mA / 12 V

Power supply data

	Type star with N	Type delta
Nominal mains voltage	230 V	400 V
Operating voltage range	160 ... 275 V	280 ... 470 V
Power consumption	1.5 W	1.5 W
Input current	1.5 mA	1.5 mA
Frequency	50 Hz	50 Hz

Insulation

Test voltage between contacts and supply	2 kVrms 1 minute (basic insulation)
--	-------------------------------------

General specifications

Ambient temperature storage /operation	-40 ... +85 °C / -25 ...+60 °C
Mechanical life of contacts	30 x 10 ⁶ operations
Ingress protection degree	IP 40 when plugged in
Housing material	Lexan, alu front plate
Weight	300 g

Standard types

AC 230 50 Hz	SSU33L/AC230V (Star connection)
AC 400 50 Hz	SSU33L/AC400V (delta connection)

Accessories: Socket:

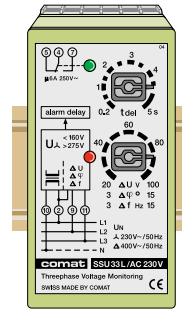
S-3B

Retention clip:

HF-24

Front panel mounting set:

FZ-23



Connection diagram

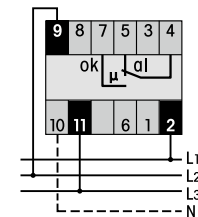


Fig.1 AC voltage endurance

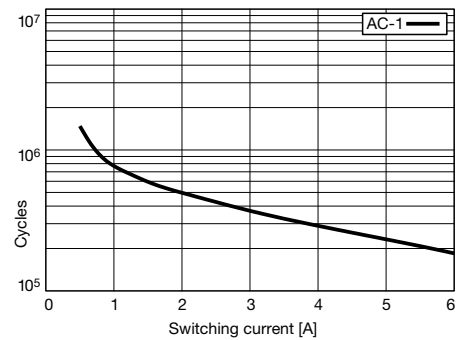
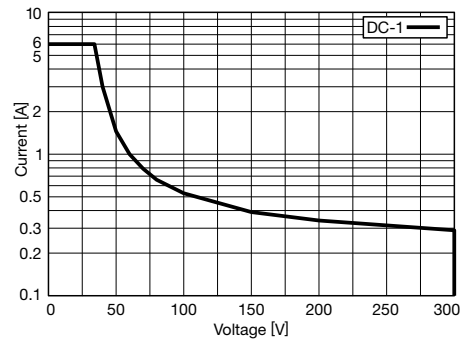
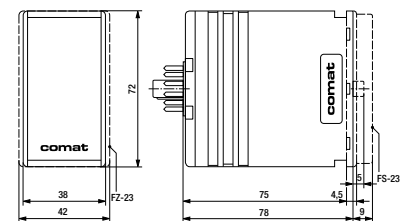


Fig. 2 DC load limit curve



Dimensions [mm]

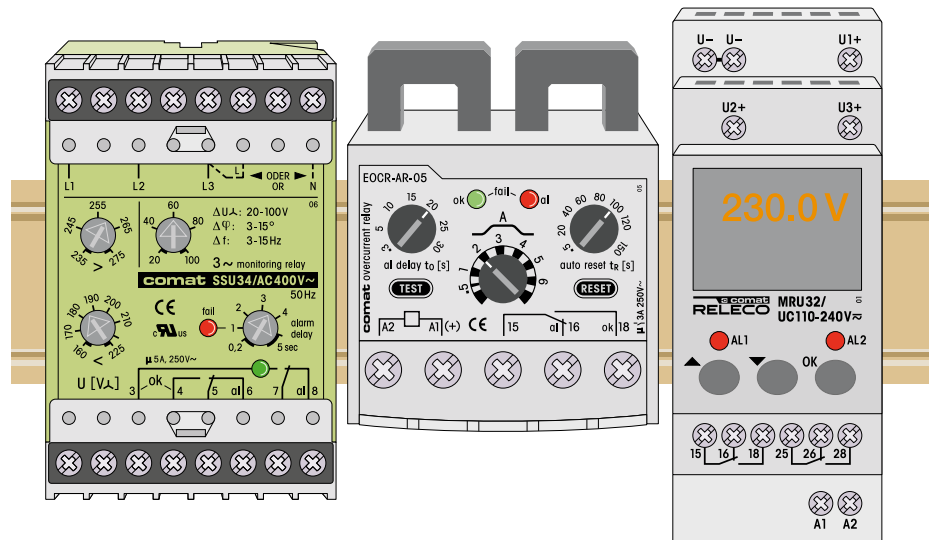


Technical approvals, conformities

EN 60947

3.2 DIN Monitoring Relays

DIN Monitoring Relays

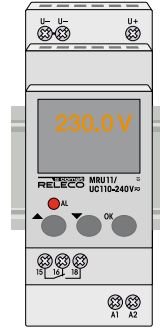
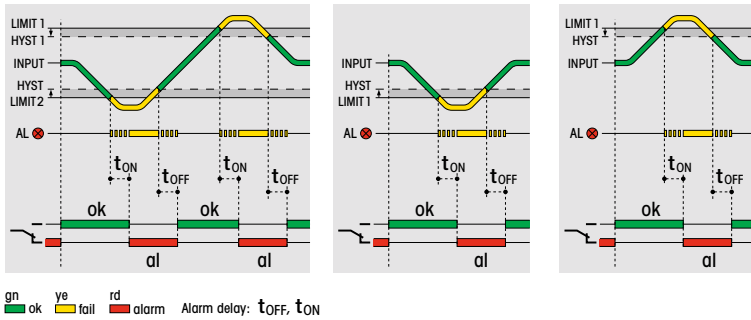


Application	Types	Monitoring	Monitoring ratings	Output contacts	Design
3.2 DIN Monitoring Relays					
Voltage monitoring, AC 15 ... 60 Hz / DC single phase	MRU11		0 ... AC 480 V / DC 700 V	1 CO	35 mm
Voltage monitoring, AC 15 ... 60 Hz / DC three phase	MRU32		0 ... AC 480 V / DC 700 V	2 CO	35 mm
Current monitoring, AC 15 ... 60 Hz / DC single phase	MRI11		0 ... 5 A	1 CO	35 mm
Current monitoring, AC 15 ... 60 Hz / DC three phase	MRI32		0 ... 5 A	2 CO	35 mm
Multifunction monitoring, AC 15 ... 60 Hz / DC single phase	MRM11	 	U, I, P, f, cosφ	1 CO	35 mm
Multifunction monitoring, AC 15 ... 60 Hz / DC three phase	MRM32	 	U, I, P, f, cosφ	2 CO	35 mm
AC Voltage monitoring, AC 50 ... 60 Hz	MV53		AC 115 V, AC 230 V	1 CO	22.5 mm
Over-current monitoring, 48 ... 62 Hz	EOCR		0.5 ... 6 A / 3 ... 30 A / 5 ... 60 A	1 CO	54 mm
Under-current monitoring, 48 ... 62 Hz	EUCR		0.5 ... 6 A / 3 ... 30 A / 5 ... 60 A	1 CO	54 mm
Mains monitoring relay, 50 Hz	SSU34		100 V, 400 V, 500 V	2 CO	50 mm
Mains monitoring relay, 60 Hz	SSU36		208 V, 460 V, 480 V	2 CO	50 mm
Isolation monitoring, DC networks	ESU-D2		1 ... 50 kΩ	1 CO / 1 CO+NO	50 mm

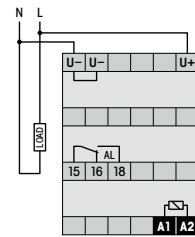
Type: MRU11/...V

Voltage monitoring relay with over- and under voltage thresholds up to 700 V.
 Alarm delay setting. Alarm LED. Display for voltmeter function, alarm signal and interactive parameter setting.
 1 change-over alarm contact 5 A 250 V. Comfortable parameter setting.

Monitoring function



Connection diagram



Measuring circuit data

Over/under voltage setting ranges AC / DC	0 ... 480 V / 0 ... 700 V
Frequency	DC, AC 16 ... 100 Hz
Resolution	100 mV
Accuracy	2 % ± 1 digit
Input resistance	1 MΩ

Time data

Alarm delay setting time	0.1 ... 999.9 s
Reset time setting range	0.1 ... 999.9 s
Voltage failure buffering	ca. 30 ms

Contacts

Type / Material	1 CO / AgNi 0.15	
Rated operational current	6 A	
Max. inrush current	15 A	
Max. switching voltage	250 V	
Max. AC load AC-1 (Fig.1)	1250 VA	
Max. DC load DC-1, 24 V / 220 V (Fig.2)	120 W / 25 V	
Recommended min. contact load	10 mA / 10 V	

Power supply

	UC12-48V	UC110-240V
Nominal voltage AC/DC	12 ... 48 V	110 ... 240 V
Operating voltage range	9.6 ... 57.6 V	88 ... 288 V
AC frequency	16 ... 63 Hz	16 ... 63 Hz
Power consumption	2 W / 4 VA	2 W / 4 VA

Insulation

Test voltage open - contact	1 kVrms 1 minute
Test voltage measuring input - contacts	4 kVrms 1 minute
Test voltage measuring input - power supply	4 kVrms 1 minute

General specifications

Ambient temperature storage /operation	-40 ... +85 °C / -25 ...+60 °C
Mechanical life of contacts	30 x 10 ⁶ operations
Conductor cross section	Stranded wire 2.5 mm ² , 2 x 1.5 mm ²
Ingress protection degree	IP20, (electronics: IP40)
Max. screw torque	0.4 Nm
Housing material	Lexan EXL 9330
Weight	130 g

Standard types

AC/DC 12-48 V, 15...60 Hz
 AC/DC 110-240 V, 15...60 Hz

MRU11/UC12-48V
 MRU11/UC110-240V

Fig.1 AC voltage endurance

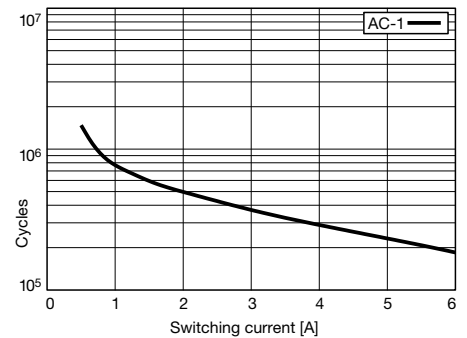
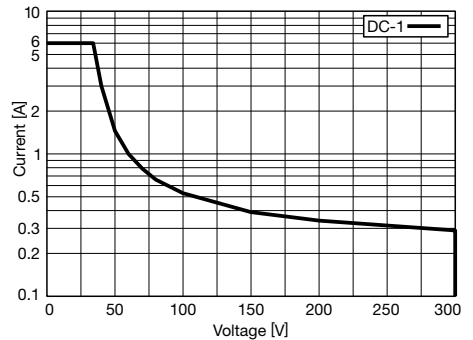
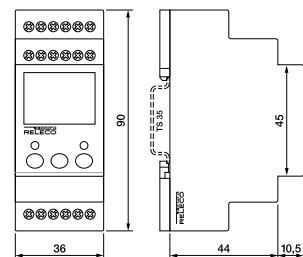


Fig. 2 DC load limit curve



Dimensions [mm]



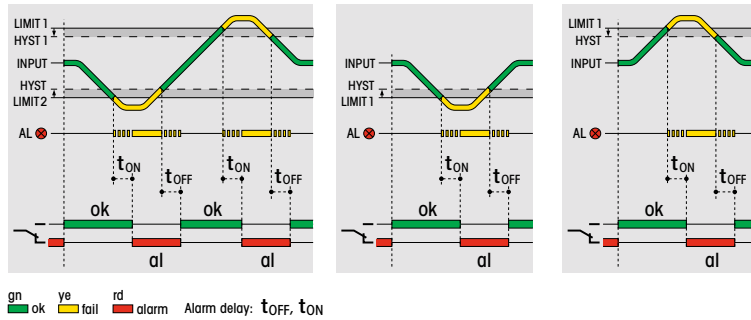
Technical approvals, conformities



Type: MRU32/...V

Voltage monitoring relay with over- and under voltage thresholds up to 700 V. Alarm delay setting. Alarm LED. Display for voltmeter function, alarm signal and interactive parameter setting. 2 change-over alarm contacts 5 A 250 V. Comfortable parameter setting.

Monitoring function



Measuring circuit data

Over/under voltage setting ranges AC / DC	0 ... 480 V / 0 ... 700 V
Frequency	DC, AC 16 ... 100 Hz
Resolution	100 mV
Accuracy	2 % ±1 digit
Input resistance	1 MΩ

Time data

Alarm delay setting time	0.1 ... 999.9 s
Reset time setting range	0.1 ... 999.9 s
Voltage failure buffering	ca. 30 ms

Contacts

Type / Material	2 CO / AgNi 0.15
Rated operational current	6 A
Max. inrush current	15 A
Max. switching voltage	250 V
Max. AC load AC-1 (Fig.1)	1250 VA
Max. DC load DC-1, 24 V / 220 V (Fig.2)	120 W / 25 W
Recommended min. contact load	10 mA / 10 V

Power supply

	UC12-48V	UC110-240V
Nominal voltage AC/DC	12 ... 48 V	110 ... 240 V
Operating voltage range	9.6 ... 57.6 V	88 ... 288 V
AC frequency	16 ... 63 Hz	16 ... 63 Hz
Power consumption	2 W / 4 VA	2 W / 4 VA

Insulation

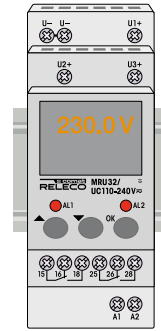
Test voltage open - contact	1 kVrms 1 minute
Test voltage between poles	2.5 kVrms 1 minute
Test voltage measuring input - contacts	4 kVrms 1 minute
Test voltage measuring input - power supply	4 kVrms 1 minute

General specifications

Ambient temperature storage /operation	-40 ... +85 °C / -25 ... +60 °C
Mechanical life of contacts	30 x 10 ⁶ operations
Conductor cross section	Stranded wire 2.5 mm ² , 2 x 1.5 mm ²
Ingress protection degree	IP20, (electronics: IP40)
Max. screw torque	0.4 Nm
Housing material	Lexan EXL 9330
Weight	130 g

Standard types

AC/DC 12-48 V, 15...60 Hz	MRU32/UC12-48V
AC/DC 110-240 V, 15...60 Hz	MRU32/UC110-240V



Connection diagram

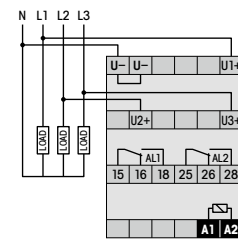


Fig.1 AC voltage endurance

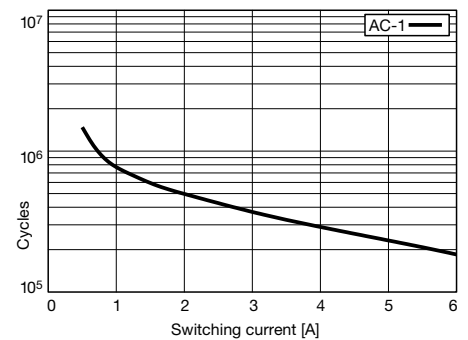
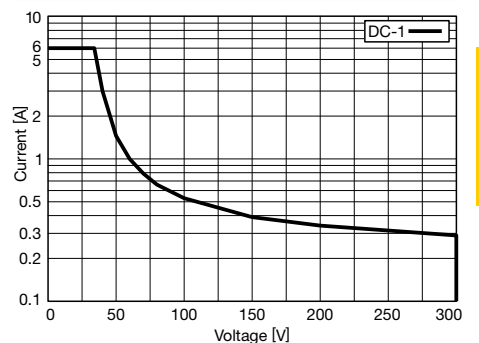
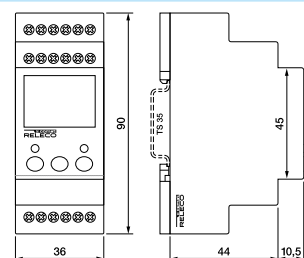


Fig. 2 DC load limit curve



Dimensions [mm]



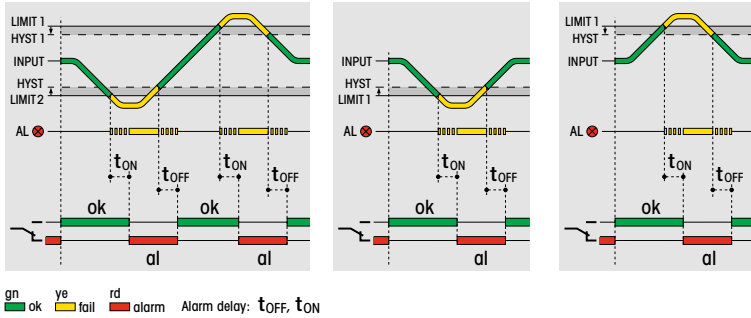
Technical approvals, conformities



Type: MRI11/...V

Current monitoring relay with over- and under voltage thresholds up to 5 A. Alarm delay setting. Alarm LED. Display for voltmeter function, alarm signal and interactive parameter setting.
 1 change-over alarm contact 5 A 250 V. Comfortable parameter setting.

Monitoring function



Measuring circuit data

Over/under current setting ranges AC / DC	0 ... 5 A
Frequency	DC, AC 16 ... 100 Hz
Resolution	1 mA
Accuracy	2 % ± 1 digit
Input resistance	5 MΩ

Time data

Alarm delay setting time	0.1 ... 999.9 s
Reset time setting range	0.1 ... 999.9 s
Voltage failure buffering	ca. 30 ms

Contacts

Type / Material	1 CO / AgNi 0.15
Rated operational current	6 A
Max. inrush current	15 A
Max. switching voltage	250 V
Max. AC load AC-1 (Fig.1)	1250 VA
Max. DC load DC-1, 24 V / 220 V (Fig.2)	120 W / 25 V
Recommended min. contact load	10 mA / 10 V

Power supply

	UC12-48V	UC110-240V
Nominal voltage AC/DC	12 ... 48 V	110 ... 240 V
Operating voltage range	9.6 ... 57.6 V	88 ... 288 V
AC frequency	16 ... 63 Hz	16 ... 63 Hz
Power consumption	2 W / 4 VA	2 W / 4 VA

Insulation

Test voltage open - contact	1 kVrms 1 minute
Test voltage measuring input - contacts	4 kVrms 1 minute
Test voltage measuring input - power supply	4 kVrms 1 minute

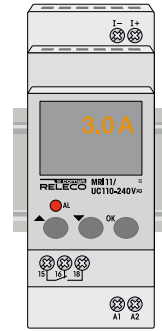
General specifications

Ambient temperature storage /operation	-40 ... +85 °C / -25 ...+60 °C
Mechanical life of contacts	30 x 10 ⁶ operations
Conductor cross section	Stranded wire 2.5 mm ² , 2 x 1.5 mm ²
Ingress protection degree	IP20, (electronics: IP40)
Max. screw torque	0.4 Nm
Housing material	Lexan EXL 9330
Weight	130 g

Standard types

AC/DC 12-48 V, 15...60 Hz
AC/DC 110-240 V, 15...60 Hz

MRI11/UC12-48V
MRI11/UC110-240V



Connection diagram

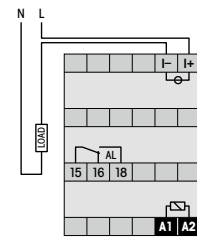


Fig.1 AC voltage endurance

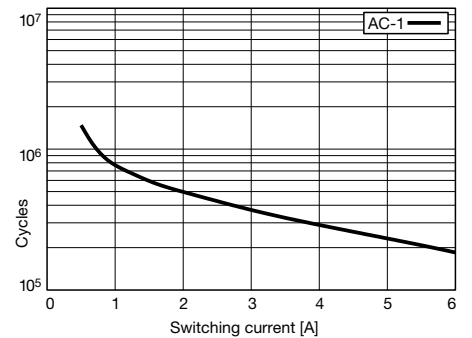
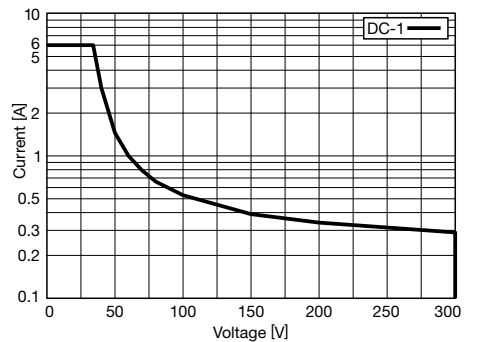
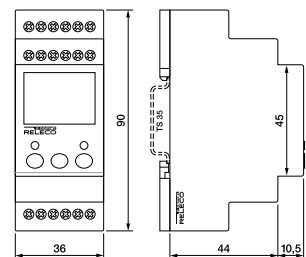


Fig. 2 DC load limit curve



Dimensions [mm]



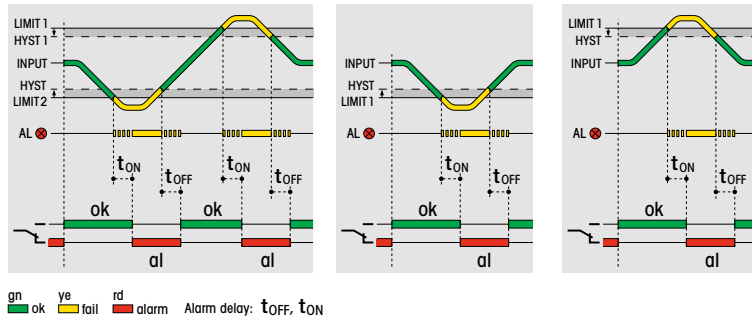
Technical approvals, conformities



Type: MRI32/...V

Current monitoring relay with over- and under current thresholds up to 5 A. Alarm delay setting. Alarm LED. Display for voltmeter function, alarm signal and interactive parameter setting. 2 change-over alarm contacts 5 A 250 V. Comfortable parameter setting.

Monitoring function



Measuring circuit data

Over/under current setting ranges AC / DC	0 ... 5 A
Frequency	DC, AC 16 ... 100 Hz
Resolution	1 mA
Accuracy	2 % ± 1 digit
Input resistance	5 MΩ

Time data

Alarm delay setting time	0.1 ... 999.9 s
Reset time setting range	0.1 ... 999.9 s
Voltage failure buffering	ca. 30 ms

Contacts

Type / Material	2 CO / AgNi 0.15	
Rated operational current	6 A	
Max. inrush current	15 A	
Max. switching voltage	250 V	
Max. AC load AC-1 (Fig.1)	1250 VA	
Max. DC load DC-1, 24 V / 220 V (Fig.2)	120 W / 25 W	
Recommended min. contact load	10 mA / 10 V	

Power supply

	UC12-48V	UC110-240V
Nominal voltage AC/DC	12 ... 48 V	110 ... 240 V
Operating voltage range	9.6 ... 57.6 V	88 ... 288 V
AC frequency	16 ... 63 Hz	16 ... 63 Hz
Power consumption	2 W / 4 VA	2 W / 4 VA

Insulation

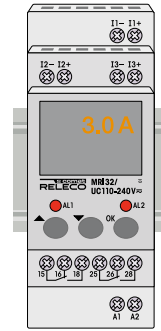
Test voltage open - contact	1 kVrms 1 minute
Test voltage between poles	2.5 kVrms 1 minute
Test voltage measuring input - contacts	4 kVrms 1 minute
Test voltage measuring input - power supply	4 kVrms 1 minute

General specifications

Ambient temperature storage /operation	-40 ... +85 °C / -25 ... +60 °C
Mechanical life of contacts	30 x 10 ⁶ operations
Conductor cross section	Stranded wire 2.5 mm ² , 2 x 1.5 mm ²
Ingress protection degree	IP20, (electronics: IP40)
Max. screw torque	0.4 Nm
Housing material	Lexan EXL 9330
Weight	130 g

Standard types

AC/DC 12-48 V, 15...60 Hz	MRI32/UC12-48V
AC/DC 110-240 V, 15...60 Hz	MRI32/UC110-240V



Connection diagram

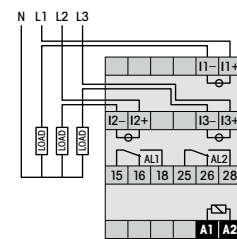


Fig.1 AC voltage endurance

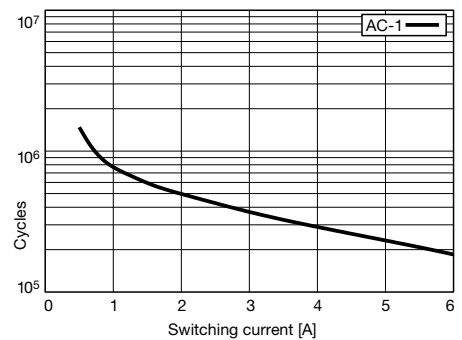
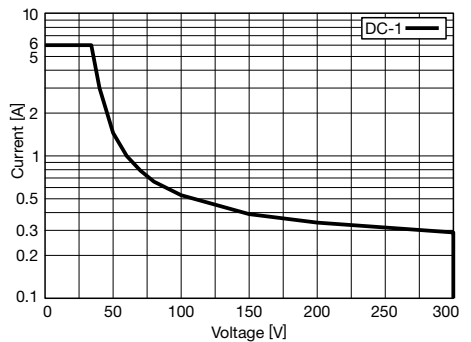
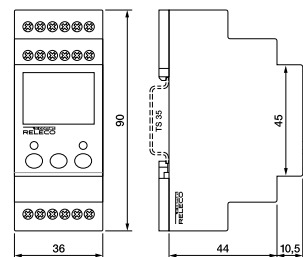


Fig. 2 DC load limit curve



Dimensions [mm]



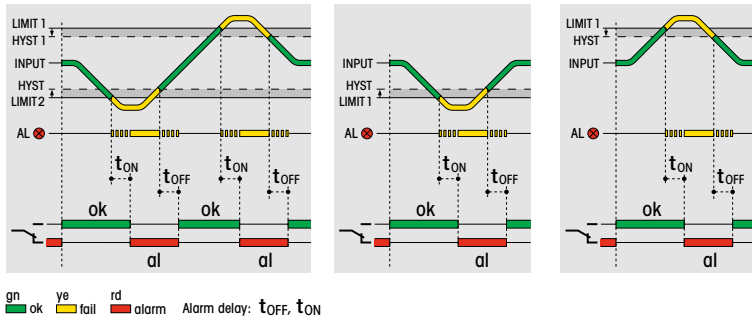
Technical approvals, conformities



Type: MRM11/...V

Multifunctional monitoring relay for simultaneous measurement of current and voltage and monitoring of U, I, P, cos φ and f. Alarm delay setting. Alarm LED. Display for multimeter function, alarm signal and interactive parameter setting.
 1 change-over alarm contact 5 A 250 V. Comfortable parameter setting.

Monitoring function



Measuring circuit data

Voltage setting ranges AC / DC	0 ... 480 V / 0 ... 700 V
Current setting ranges AC / DC	0 ... 5 A
Frequency	DC, AC 16 ... 100 Hz
Resolution U / I	100 mV / 1 mA
Accuracy	2 % ±1 digit
Input resistance U / I	1 MΩ / 5 MΩ

Time data

Alarm delay setting time	0.1 ... 999.9 s
Reset time setting range	0.1 ... 999.9 s
Voltage failure buffering	ca. 30 ms

Contacts

Type / Material	1 CO / AgNi 0.15
Rated operational current	6 A
Max. inrush current	15 A
Max. switching voltage	250 V
Max. AC load AC-1 (Fig.1)	1250 VA
Max. DC load DC-1, 24 V / 220 V (Fig.2)	120 W / 25 V
Recommended min. contact load	10 mA / 10 V

Power supply

	UC12-48V	UC110-240V
Nominal voltage AC/DC	12 ... 48 V	110 ... 240 V
Operating voltage range	9.6 ... 57.6 V	88 ... 288 V
AC frequency	16 ... 63 Hz	16 ... 63 Hz
Power consumption	2 W / 4 VA	2 W / 4 VA

Insulation

Test voltage open - contact	1 kVrms 1 minute
Test voltage measuring input - contacts	4 kVrms 1 minute
Test voltage measuring input - power supply	4 kVrms 1 minute

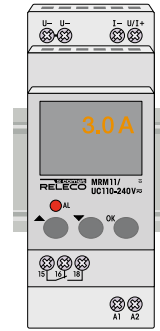
General specifications

Ambient temperature storage /operation	-40 ... +85 °C / -25 ...+60 °C
Mechanical life of contacts	30 x 10 ⁶ operations
Conductor cross section	Stranded wire 2.5 mm ² , 2 x 1.5 mm ²
Ingress protection degree	IP20, (electronics: IP40)
Max. screw torque	0.4 Nm
Housing material	Lexan EXL 9330
Weight	130 g

Standard types

AC/DC 12-48 V, 15...60 Hz
AC/DC 110-240 V, 15...60 Hz

MRM11/UC12-48V
MRM11/UC110-240V



Connection diagram

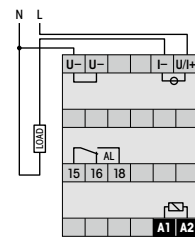


Fig.1 AC voltage endurance

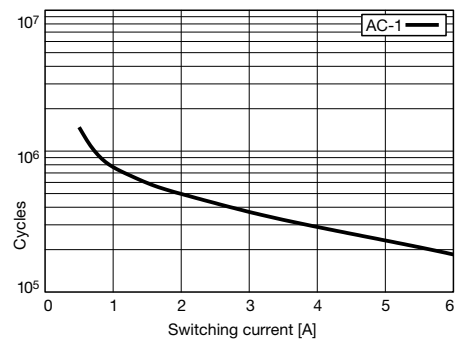
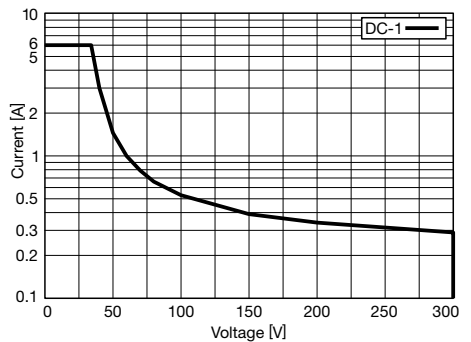
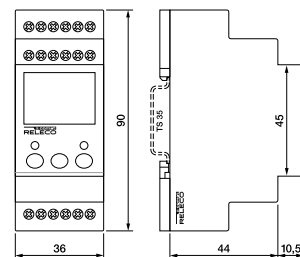


Fig. 2 DC load limit curve



Dimensions [mm]



Technical approvals, conformities



MRM32

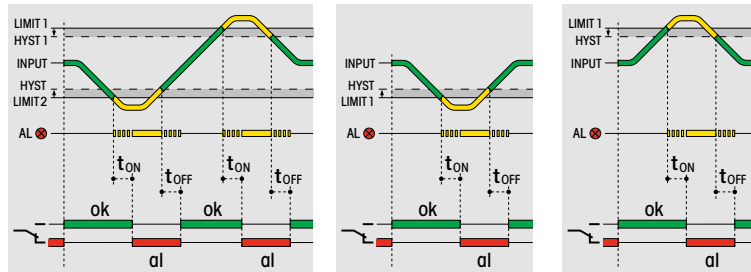
Multifunction monitoring relay AC/DC, three phase DIN Rail mounting according to DIN 43 880

Type: MRM32/...V

Multifunctional monitoring relay for simultaneous measurement of current and voltage and monitoring of U, I, P, $\cos\phi$ and f and $\Delta\phi$. Alarm delay setting. Alarm LED. Display for multimeter function, alarm signal and interactive parameter setting.

2 change-over alarm contacts 5 A 250 V. Comfortable parameter setting.

Monitoring function



gn ok ye fail rd alarm Alarm delay: t_{OFF} , t_{ON}

Measuring circuit data

Voltage setting ranges AC / DC	0 ... 480 V / 0 ... 700 V
Current setting ranges AC / DC	0 ... 5 A
Frequency	DC, AC 16 ... 100 Hz
Resolution U / I	100 mV / 1 mA
Accuracy	2 % \pm 1 digit
Input resistance U / I	1 M Ω / 5 M Ω

Time data

Alarm delay setting time	0.1 ... 999.9 s
Reset time setting range	0.1 ... 999.9 s
Voltage failure buffering	ca. 30 ms

Contacts

Type / Material	2 CO / AgNi 0.15
Rated operational current	6 A
Max. inrush current	15 A
Max. switching voltage	250 V
Max. AC load AC-1 (Fig.1)	1250 VA
Max. DC load DC-1, 24 V / 220 V (Fig.2)	120 W / 25 W
Recommended min. contact load	10 mA / 10 V

Power supply

	UC12-48V	UC110-240V
Nominal voltage AC/DC	12 ... 48 V	110 ... 240 V
Operating voltage range	9.6 ... 57.6 V	88 ... 288 V
AC frequency	16 ... 63 Hz	16 ... 63 Hz
Power consumption	2 W / 4 VA	2 W / 4 VA

Insulation

Test voltage open - contact	1 kVrms 1 minute
Test voltage between poles	2.5 kVrms 1 minute
Test voltage measuring input - contacts	4 kVrms 1 minute
Test voltage measuring input - power supply	4 kVrms 1 minute

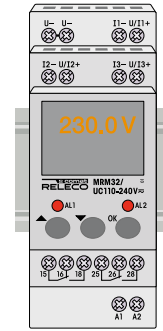
General specifications

Ambient temperature storage /operation	-40 ... +85 °C / -25 ... +60 °C
Mechanical life of contacts	30 x 10 ⁶ operations
Conductor cross section	Stranded wire 2.5 mm ² , 2 x 1.5 mm ²
Ingress protection degree	IP20, (electronics: IP40)
Max. screw torque	0.4 Nm
Housing material	Lexan EXL 9330
Weight	130 g

Standard types

AC/DC 12-48 V, 15...60 Hz
AC/DC 110-240 V, 15...60 Hz

MRM32/UC12-48V
MRM32/UC110-240V



Connection diagram

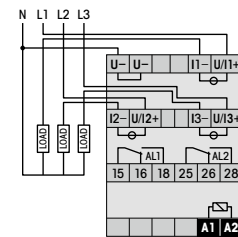


Fig.1 AC voltage endurance

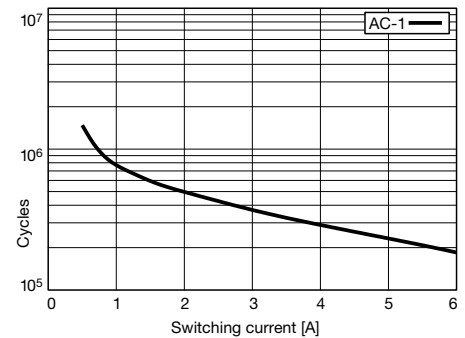
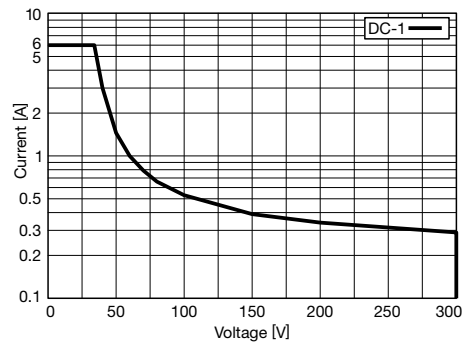
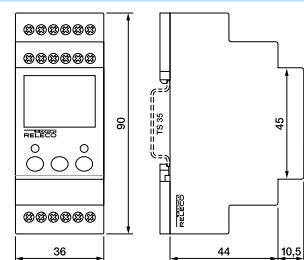


Fig. 2 DC load limit curve



Dimensions [mm]



Technical approvals, conformities

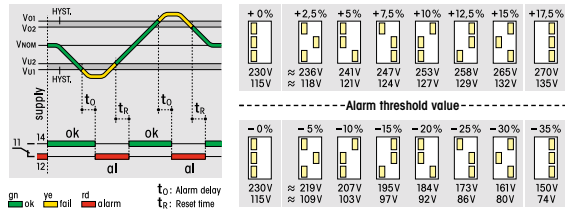


Type: MV53 /... V

Voltage monitoring relay with over- and under voltage thresholds. Adjustable alarm delay. Alarm LED. Threshold setting by DIP switch. 1 change over alarm contact 6 A 250 V. Very suitable for protecting of contactor coils against under voltage (under voltage → low Z of coil → over current → defective).

Monitoring function

Threshold settings in % of nominal voltage. Do not set 0 % for both thresholds.



Measuring circuit data

Nominal voltage V_{nom} , type	AC 115 V / AC 230 V
Over voltage setting range (2.5 % steps)	0 ... 17.5 % from V_{nom}
Under voltage setting range (5 % steps)	0 ... - 35 % from V_{nom}
Frequency range	45 ... 65 Hz
Accuracy	± 3 %

Time data

Fault detection time	100 ms
Alarm delay adjustment range	25 ms ... 2.5 s
Voltage failure buffering	≥ 10 ms

Contacts

Type / Material	1 CO, micro disconnection / AgNi
Rated operational current	6 A
Max. inrush current (10 ms)	15 A
Max. switching voltage	250 V
Max. AC load AC-1 (Fig.1)	1500 VA
Max. DC load DC-1, 24 V / 220 V (Fig.2)	120 W / 65 W
Recommended min. contact load	100 mA / 5 V

Power supply

	AC 115 V	AC 230 V
Nominal voltage	AC 115 V	AC 230 V
Operating voltage range	65 ... 135 V	130 ... 270 V
Power consumption	2.2 W	2.2 W
Frequency range	45 ... 65 Hz	45 ... 65 Hz
Surge immunity EN 6100-4-5	2 kV	2 kV

Insulation

Test voltage open contact	1 kVrms 1 minute
Test voltage between contact and power supply	2 kVrms 1 minute

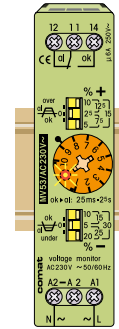
General specifications

Ambient temperature storage /operation	-40 ... +85 °C / -25 ...+60 °C
Mechanical life of contacts	20 x 10 ⁶ operations
Conductor cross section	Stranded wire 2.5 mm ² , 2 x 1.5 mm ²
Ingress protection degree	Housing: IP 40, terminals: IP 20
Max. Screw torque	0.4 Nm
Housing material	Lexan
Weight	80 g

Standard types

AC 115 50 / 60 Hz
AC 230 50 / 60 Hz

MV53/AC115V
MV53/AC230V



Connection diagram

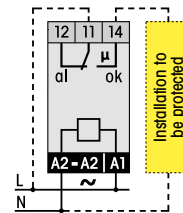


Fig.1 Contact endurance

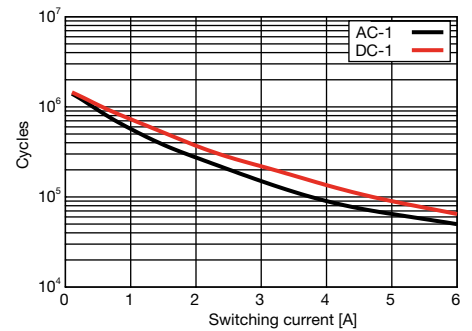
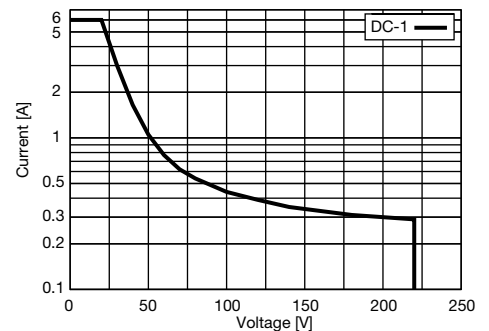
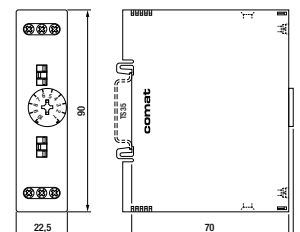


Fig. 2 DC load limit curve



Dimensions [mm]



Technical approvals, conformities



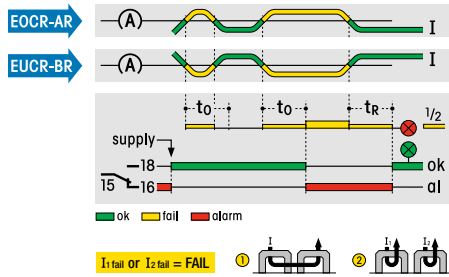
EOCR, EUCR

Current monitoring relay with 2 current inputs DIN Rail mounting according to DIN 43 880

Type: EOCR-AR-... / ... V (Over current), EUCR-BR-... / ... V (Under current)

AC current monitoring relay for 1 or 3 phase lines, 1 change over alarm contact 3 A / 250 V
Integrated current transformer coupling system, 6 A, 30 A, 60 A types

Monitoring function



The EOCR-AR and the EUCR-BR monitor over-current and undercurrent on AC power circuits. One or two current paths can be monitored directly up to 60 (75) A, by means of the integrated current loop transformers. The adjustable alarm delay (t_0) and the automatic alarm resetting (t_R) permit universal usage in motor and transformer protection systems, monitoring of electrical heating elements and in the control of pumps, ventilation systems, suction and feed devices.

Measuring circuit data

Setting ranges	0.5 ... 6 A / 3 ... 30 A / 5 ... 60 A
Frequency range	48 ... 62 Hz
Accuracy	2.5 %
Hysteresis	3 % from set value
Max. continuous current 6 / 30 / 60 A type	60 A / 90 A / 120 A
Peak current (1 sec) 6 / 30 / 60 A type	3 kA / 5 kA / 5 kA

1) Expansion of the current ranges:
Lower currents (see table at right):
Higher currents:

Two or more loops through the current transformer.
External current transformer. See accessories.

Time data

Alarm delay time adjustment range	0.3 ... 30 s
Reset time adjustment range	0.5 ... 150 s
Response time, power on, on A1	80 ... 150 ms

Contacts

Type / Material	1 CO, micro disconnection / AgNi
Rated operational current	3 A
Max. switching voltage, AC-1	250 V
Max. AC load	750 VA
Max. DC load	90 W

Power supply

	UC 24 V	AC 115 V	AC 230 V
Nominal voltage (UC = AC/DC)			
Operation voltage range [V]	19 ... 30	88 ... 130	184 ... 264
Power consumption [W]	1.5	1.5	1.5
Frequency [Hz]	50 / 60	50 / 60	50 / 60

Insulation

Test voltage between contacts and supply inp.	2 kVrms 1 minute
Test voltage between curr. transf. and other circuits	4 kVrms 1 minute

General specifications

Ambient temperature storage /operation	-25 ... 85 °C / -20 ... 60 °C
Ingress protection degree	Housing: IP 40, terminals: IP 20
Max. screw torque	0.8 Nm
Weight	120 g

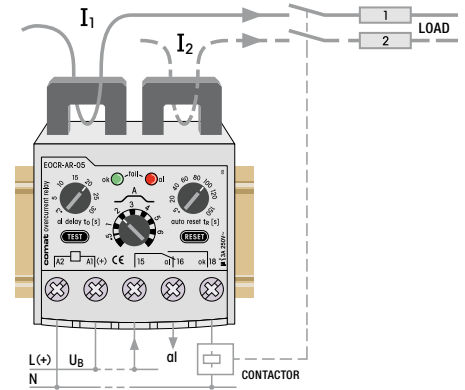
Standard types

Current [x] 05/30/60

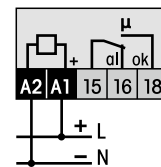
Over current	Under current
EOCR-AR- x /UC24V	EUCR-BR-x /UC24V
EOCR-AR- x /AC115V	EUCR-BR-x /AC115V
EOCR-AR- x /AC230V	EUCR-BR-x /AC230V

Accessories

Current transformer for expanded current values, 50, 100, 250, 500 A **SRCT-35-.../5A**



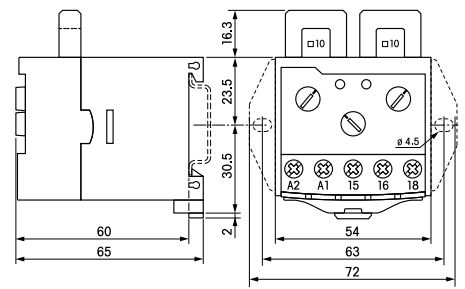
Connection diagram



Expansion of current ranges

[A]	1x	2x	3x	4x	5x
-05	0,5-6	0,25-3	0,17-2	0,13-1,5	0,1-1,2
-30	2,5-30	1,25-15	0,83-10	0,62-7,5	0,5-6
-60	5-60	2,5-30	1,7-20	1,25-15	1-12

Dimensions [mm]



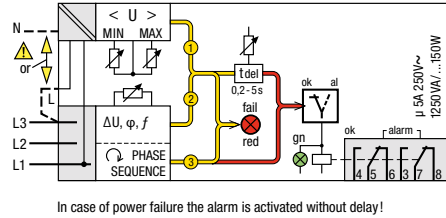
Technical approvals, conformities



Type: SSU34/... V

Monitoring relay for under / over voltage, phase sequence, phase loss, phase angle, frequency, asymmetry. Star or delta operation. 2 change over alarm contacts 6 A 250V

Monitoring function



The SSU34 (50Hz) provide comprehensive monitoring of three-phase mains supplies with or without neutral.

The following mains faults are monitored:

Error signal ① U (V_{Δ} , V_{λ}):

Exceeding or dropping below the set voltage values U_{min}/U_{max} for L1-N or L1-L3,L (no differential voltage, phase position or frequency fault).

Error signal ② ΔU , $\Delta \phi$, Δf :

One or more of the three voltages, phase positions, or the mains frequency are diverging from the required value. Depending on the nature of their occurrence Δ -errors are evaluated cumulatively.

Error signal ③:

Connection polarity reversal (wrong phase-sequence). Any error is signalled by the red LED "fail" and is reported after expiry of the set alarm-delay time (for error signal ③ undelayed) via 5-6 and 7-8.

In the correct status (ok) the green LED is illuminated (5-6 and 7-8 open, 5-4 and 7-3 closed).

Measuring circuit data

Nominal mains voltage	100 V	400 V	500 V
Under voltage adj. range [V] ¹⁾	40 ... 55	160 ... 225	200 ... 280
Over voltage adj. range [V] ¹⁾	61 ... 70	235 ... 275	300 ... 350
Δ voltage adj. range [V] ²⁾	5 ... 25	20 ... 100	20 ... 100
$\Delta \phi$ adjustment range [°] ²⁾	3 ... 15	3 ... 15	3 ... 15
Δf adjustment range [Hz] ²⁾	3 ... 15	3 ... 15	3 ... 15

¹⁾ L - N ²⁾ adjustment with the same rotary knob

Time data

Alarm delay adjustment range	0.2 ... 5 s
Reset time	100 ... 400 ms

Contacts

Type / material	2 CO, micro disconnection / AgNi
Rated operational current	5 A
Max. inrush current (20 ms)	15 A
Max. AC switching voltage AC-1	250 V
Max. AC load AC-1 (Fig.1)	1250 VA
Max. DC load 30 V / 250 V DC-1	150 W / 60 W
Recommended min. contact load	10 mA / 12 V

Power supply data

Nominal mains voltage	100 V	400 V	500 V
Operating voltage range [V] ¹⁾	35 ... 70	140 ... 285	180 ... 360
Power consumption [W]	≤ 1.5	≤ 1.5	≤ 1.5
Input current [mA]	150	30	25
Frequency [Hz]	50	50	50

Insulation

Test voltage between contacts and supply	3 kVrms 1 minute (basic insulation)
--	-------------------------------------

General specifications

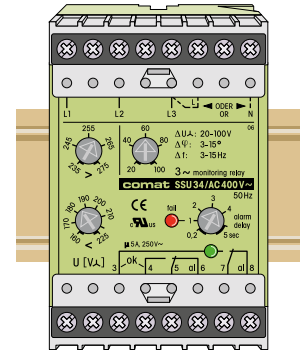
Ambient temperature storage /operation	-40 ... +85 °C/-10 ... +60 °C
Mechanical life of contacts	30 x 10 ⁶ operations
Ingress protection degree	Housing: IP 40, terminals: IP 20
Max. screw torque	0.5 Nm
Housing material / Weight	Lexan / 350 g

Standard types

50 Hz, AC 100, 400, 500

"..." enter the voltage for full type designation

SSU34/AC...V



Connection diagram

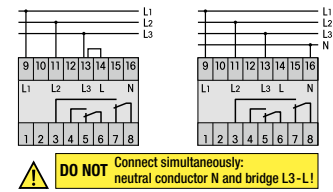


Fig. 1 AC electrical endurance

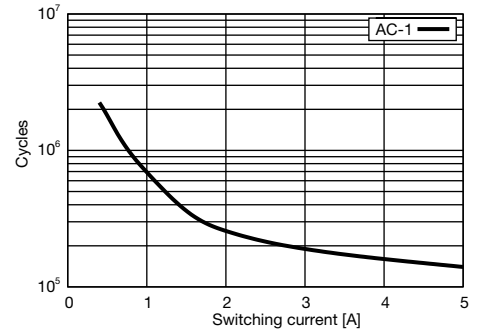
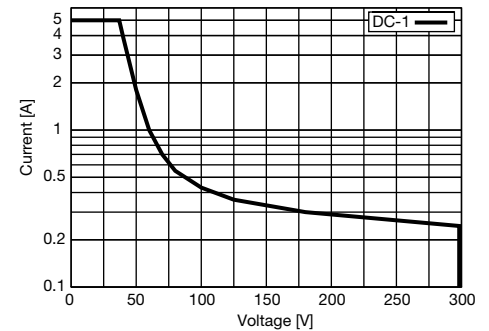
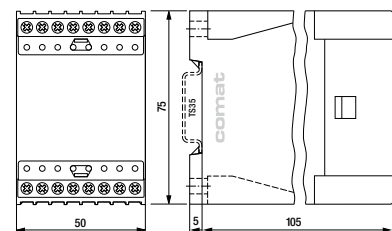


Fig. 2 DC load limit curve



Dimensions [mm]



Technical approvals, conformities

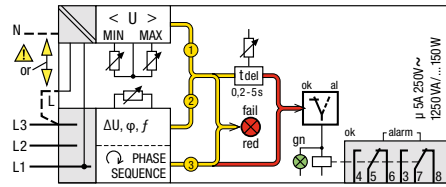
EN 60947



Type: SSU36/... V

Monitoring relay for under / over voltage, phase sequence, phase loss, phase angle, frequency, asymmetry. Star or delta operation. 2 change over alarm contacts 6 A 250V

Monitoring function



In case of power failure the alarm is activated without delay!

The SSU36 (60Hz) provide comprehensive monitoring of three-phase mains supplies with or without neutral.

The following mains faults are monitored:

Error signal \odot U (V_{Δ} , V_{Λ}):

Exceeding or dropping below the set voltage values U_{min}/U_{max} for L1-N or L1-L3,L (no differential voltage, phase position or frequency fault).

Error signal \odot ΔU , $\Delta \phi$, Δf :

One or more of the three voltages, phase positions, or the mains frequency are diverging from the required value. Depending on the nature of their occurrence Δ -errors are evaluated cumulatively.

Error signal \odot :

Connection polarity reversal (wrong phase-sequence). Any error is signalled by the red LED "fail" and is reported after expiry of the set alarm-delay time (for error signal \odot undelayed) via 5-6 and 7-8.

In the correct status (ok) the green LED is illuminated (5-6 and 7-8 open, 5-4 and 7-3 closed).

Measuring circuit data

Nominal mains voltage	208 V	460 V	480 V
Under voltage adj. range [V] ¹⁾	85 ... 115	186 ... 260	194 ... 270
Over voltage adj. range [V] ¹⁾	125 ... 145	270 ... 318	284 ... 332
Δ voltage adj. range [V] ^{1) 2)}	10 ... 50	20 ... 100	20 ... 100
$\Delta \phi$ adjustment range [°] ²⁾	5 ... 24	4 ... 21	4 ... 21
Δf adjustment range [Hz] ²⁾	3 ... 22	3 ... 19	3 ... 19

¹⁾ L - N ²⁾ adjustment with the same rotary knob

Time data

Alarm delay adjustment range	0.2 ... 5 s
Reset time	100 ... 400 ms

Contacts

Type / material	2 CO, micro disconnection / AgNi
Rated operational current	5 A
Max. inrush current (20 ms)	15 A
Max. AC switching voltage AC-1	250 V
Max. AC load AC-1 (Fig.1)	1250 VA
Max. DC load 30 V / 250 V DC-1	150 W / 60 W
Recommended min. contact load	10 mA / 12 V

Power supply data

Nominal mains voltage	208 V	460 V	480 V
Operating voltage range [V] ¹⁾	75 ... 150	160 ... 331	170 ... 346
Power consumption [W]	≤ 1.5	≤ 1.5	≤ 1.5
Input current [mA]	70	25	25
Frequency [Hz]	60	60	60

Insulation

Test voltage between contacts and supply	3 kVrms 1 minute (basic insulation)
--	-------------------------------------

General specifications

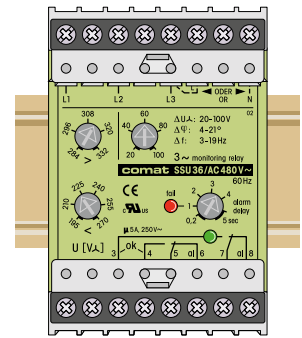
Ambient temperature storage /operation	-40 ... +85 °C / -10 ... +60 °C
Mechanical life of contacts	30 x 10 ⁶ operations
Ingress protection degree	Housing: IP 40, terminals: IP 20
Max. screw torque	0.5 Nm
Housing material / Weight	Lexan / 350 g

Standard types

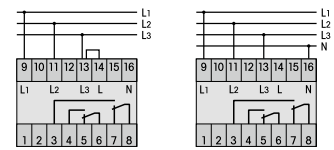
60 Hz , AC 208, 460, 480

"..." enter the voltage for full type designation

SSU36/AC...V



Connection diagram



DO NOT Connect simultaneously: neutral conductor N and bridge L3-L1!

Fig. 1 AC electrical endurance

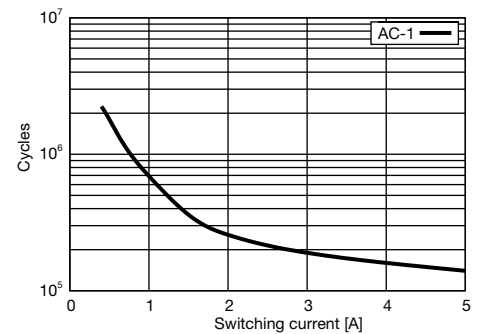
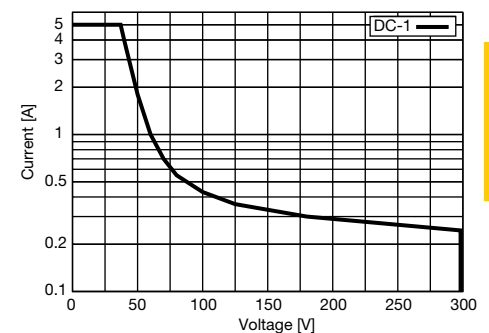
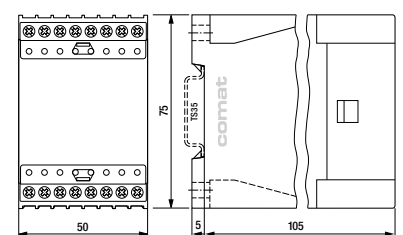


Fig. 2 DC load limit curve



Dimensions [mm]



Technical approvals, conformities



ESU-D2

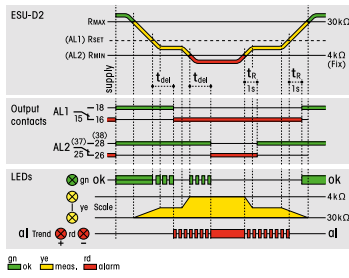
Insulation monitoring relay for unearthed DC-networks DIN Rail mounting according to DIN 43 880



Type: ESU-D2/... V

Earth insulation resistance monitoring relay
Pre alarm 1 CO and main alarm 1 NO + 1 CO contact outputs 5 A / 250 V
UC 24 ... 48 V, UC 110 ... 240 V operating voltages, monitoring of
DC 12 ... 48 V power supply networks. Monitoring of earth interruption on the device.
The device measures single or combined resistances occurring against + or - pole of the
DC network. Adjustable alarm delay. Proved reliability in rolling stock applications.

Monitoring function



The ESU-D2 monitors the isolation resistance in non-grounded DC-networks (24 – 48 V).
Two alarm steps (prealarm AL1 and main alarm AL2) are indicated via separate output contacts.
Displays: bargraph-display of the measured earthing resistance (green = ok). Two red LEDs show the ground tendency towards plus (+) or minus (-).
Output terminals 5 V for the external display of the earthing resistance (0,1 V/kΩ).
Test functions: Periodic automatic check, also with key "Test".
Environmental failures: monitoring of AC-short circuit, over-voltage, ground interruption.

Measuring circuit data

Measuring / setting range for pre alarm	1 ... 50 kΩ / 4 ... 30 kΩ
Constant value for main alarm	4 kΩ
Tolerance	≤ 10 %
Overvoltage alarm level of DC network	60 V
Input current + → -	≤ 5 mA
Sampling current pulses +/- → earth	0.2 mA
Overvoltage safety from earth to +/- poles	AC 250 V
Max. capacity +/- → earth	1.5 μF ¹⁾

¹⁾ Types for capacitances until 60 μF on request

Time data

Alarm delay time adjustment range	0.1 ... 10 s
Fault detection time	800 ms
Auto reset time, fail to OK	1 s

Contacts

Type / Material	2 CO, 1 NO micro disconnection / AgNi
Rated operational current / min. contact load	5 A / 1 mA 12 V
Max. switching voltage (Fig. 1)	250 V

Power supply

	UC 24-48 V	UC 110 – 240 V
Nominal voltage	18 ... 60 V	88 ... 265 V
Operation voltage range	2 W	2 W
Power consumption	≥ 50 ms	≥ 50 ms
Voltage failure buffering		

Insulation

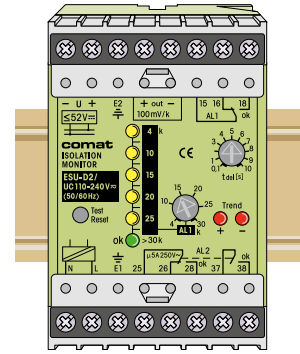
Test voltage contacts to other circuits	2 kVrms 1 minute
---	------------------

General specifications

Ambient temperature storage /operation	-40 ... 85 °C / -10 ... 60 °C
Ingress protection degree	Housing: IP 40, terminals: IP 20
Max. screw torque	0.5 Nm
Weight	250 g

Standard types

UC 110-240	ESU-D2/UC110-240V
UC24-48	ESU-D2/UC24-48V



Connection diagram

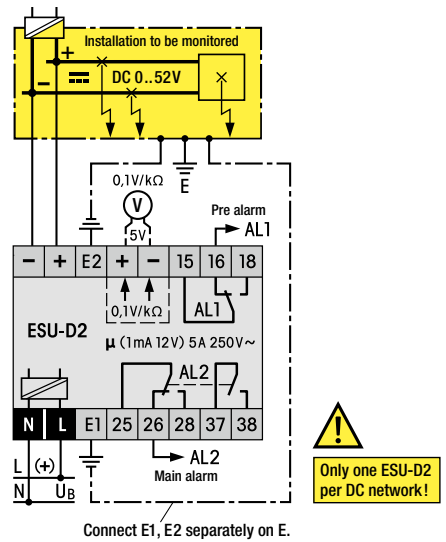
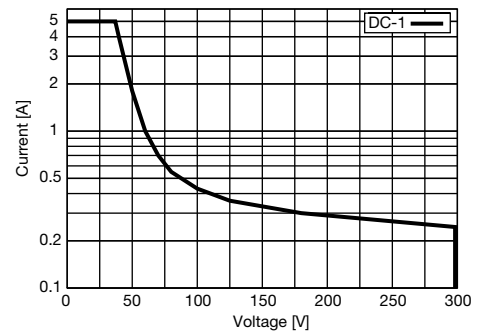
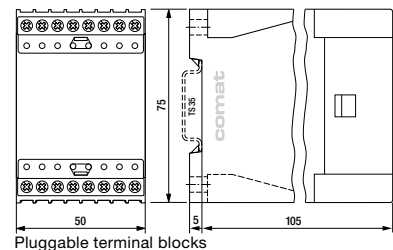


Fig. 1 DC load limit curve



Dimensions [mm]



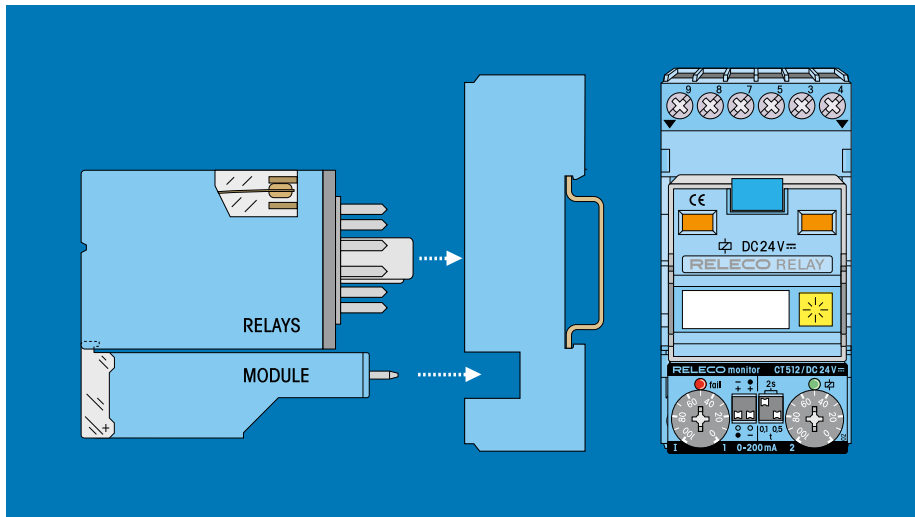
Technical approvals, conformities

EN 60947



3.3 Monitoring Modules

Modular plug-in Monitoring Relays



The modular monitoring system consists of individual plug-in monitoring modules with front cover, an 11-pole plug-in relay and a system socket with retaining spring.

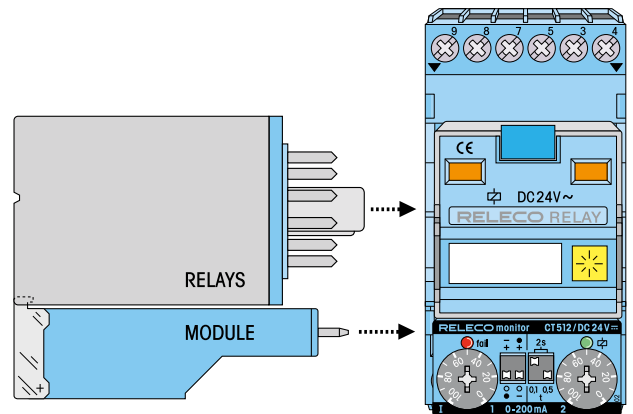
The individual combination allows an optimal device selection for the foreseen application.

Later modifications as for example an exchange of relay from mechanical contacts to a relay with solid-state outputs are possible at any time. The user profits of a universal system of worldwide unique flexibility.

The modular Comat monitoring CT System

The monitoring relays consist of plug-in CT electronic modules and 11-pole output relays. Both system components can be combined in a variety of combinations. This allows adapting the system for the specific application. Subsequent modifications, for example a change from mechanical contacts to solid-state outputs, are possible at any time just by replacing the relay.

This system provides the user a complete universal system with worldwide unmatched flexibility.



The system sockets C12B0 or CS-155 serve as a basis for the secure reception of the electronic modules. The sockets have a 4-pole module slot in which the CT modules lock firmly and vibration proof also without the output relay. Contact is made with reliable twin knife contacts.

With the A2 connector bridge "C-A2", the neutral conductor (N/-) can be connected from socket to socket. It reduces wiring work considerably.

Robust terminals for wires up to 4mm² and spacious labeling are other advantages of this practical Comat modular system.

Clear markings close to the terminal connections on the sockets make it easy to identify the connections for wiring and servicing.

The CT modules are proof of the practical oriented experiences of Comat in the field of industrial electronics. All control and display elements are arranged easy accessible at all times on the front side of the modules. The functions and settings are self-explanatory schematically illustrated on the front and allow to review the set values also during operation.

A transparent cover over the module setting components provides protection from unintentional settings and additionally links the module to the output relay.

Triggering is performed with the operating voltage. (L1 or +). No potential-free contacts are therefore required. The triggering complies to machine standards. Parallel connection to B1 is admissible.

The output relays show the connection diagram and the technical values on the front side, (exception C3 and C5 relays). A color code indicates an AC coil with red and a DC coil with blue color. Most of the relays have a lockable test button for manual operation.

The standard contacts have proven its reliability for high switching current applications over many years. The contact material AgNi permits a wide switching range and due to the large dimensioning they are designed for a high number of switching cycles. The high breaking capacity of up to 10A/400V and a low load switching capability of 12V/10mA makes the contact suitable for the use in main circuits as well as for low voltage applications.

The twin contacts are switching the load circuit with 2 independent contact tongues. The switching safety for low currents is therefore 100 times higher compared to a single contact relay. Despite the high switching capacity of up to 6A/250V, these contacts are very suitable to switch low currents and voltages up to 1mA/6V.

The solid-state relays are an alternative to mechanical relays. In the standard version, the relay has a potential-free universal semiconductor output for AC or DC loads. The advantage is a bouncing- and wear-free, overload resistant, short circuit protected output with a practical unlimited life cycle.

Solid-state relays are specially recommended for applications of high switching cycles, for example for repeat cycle timers, flushing lights, but also for high inductive switching loads of solenoid valves, couplings, motors, etc. The solid state relays are also suitable for capacitive loads, for example long power lines, or compensated lighting circuits.

Additional protection circuits of the output or of the load are not necessary in any application for this type of Comat relays.

The solid-state relays are insensitive in any aggressive environment such as chemical plants, sewage plants etc. and are therefore an excellent choice for the employment in such environments.



The train symbol indicates products available in a special railway execution according EN 50155. Please refer to our special railway brochure for details.

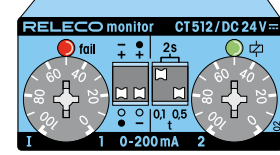
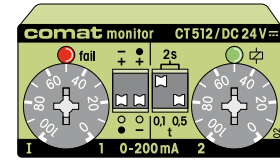
CT512, CT515, CT516

Plug-in current monitoring modules (combined with industrial relays)
0.2 A, 2 A, 6 A. DC 24 V operation

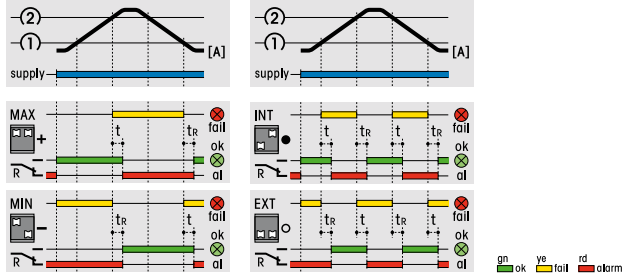


Type	Blue: CT512, CT515, CT516 /24V R	CT512R, CT515R, CT516R /36V R
	Green: CT512, CT515, CT516 /24V	CT512R, CT515R, CT516R /36V

Plug-in current monitoring modules for sockets with module slot in combination with plug-in relays. DC 24 V operation. LED alarm state indicators for OK and fail.
 Separate adjustment of upper and lower level.



Monitoring functions



Over / under voltage internal / external range

Measuring circuit data

Type	CT512	CT515	CT516
Measuring and setting ranges (rotary knobs)	0 ... 200 mA	0 ... 2 A	0 ... 6 A
Max. current 100% duty cycle	300 mA	3 A	7 A
Voltage drop on internal shunt res. @ I _{max}	300 mV	200 mV	100 mV
Temperature drift -25 ... 60 °C	≤ 3 %	≤ 3 %	≤ 3 %

Time data

Alarm delay time settings	100 ms, 500 ms, 2 s
Reset time	100 ms

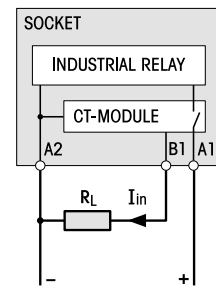
Power supply

	DC 24 V	DC 36 V
Nominal voltage	18 ... 30 V	18 ... 45 V
Operation voltage range	3 ... 7 mA	5 mA
Supply current	- 30 V	- 51 V
Polarity reversal protection		

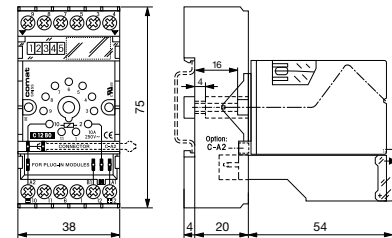
General specifications

Ambient temperature storage/operation	-40 ... 85 °C / -25 ... 60 °C
Ingress Protection degree	IP 40 when plugged in
Housing material	Lexan
Weight	25 g

Connection diagram



Dimensions [mm]



Standard types

CT512/, CT515/, CT516/ DC24	Blue CT51x/DC24V R	Green CT51x/DC24V
-----------------------------	-----------------------	----------------------

Railway types:

CT512R/, CT515R/, CT516R/ DC24		CT51xR/DC24V
CT512R/, CT515R/, CT516R/ DC36		CT51xR/DC36V

Remark: This module is part of several ready for connection units consisting of socket, relay and module.
 A wide variety of suitable relays is available.

Technical approvals, conformities

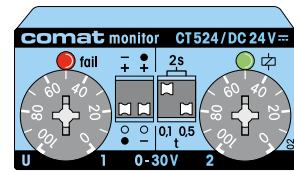


CT524

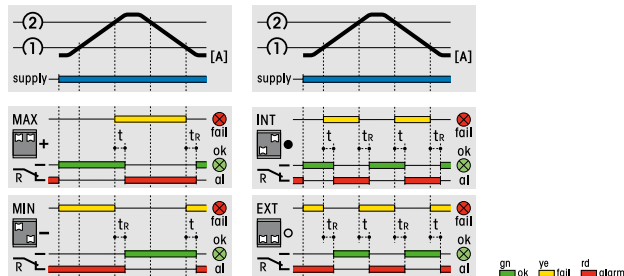
Plug-in DC voltage monitoring module. DC 24 V operation.
(combined with industrial relays)

Type **Blue:** **CT524/24V R**
 Green: **CT524/24V**

Plug-in DC voltage monitoring module for sockets with module slot in combination with 11p plug-in relays. DC 24 V operation. LED alarm state indicators for OK and fail.
Separate adjustment of upper and lower level.



Monitoring functions



Over / under voltage internal / external range

Measuring circuit data

Type	CT524
Measuring and setting ranges (rotary knobs)	0 ... 30 V
Over voltage (10 ms)	± 150 V
Input resistance	106 kΩ
Temperature drift -25 ... 60 °C	≤ 2 %

Time data

Alarm delay time settings	100 ms, 500 ms, 2 s
Reset time	100 ms

Power supply

Nominal voltage	DC 24 V
Operation voltage range	18 ... 30 V
Supply current	8 ... 13 mA
Polarity reversal protection (1 minute)	- 30 V

General specifications

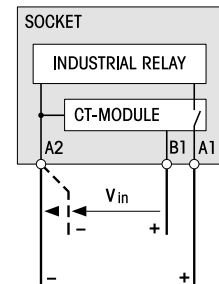
Ambient temperature storage/operation	-40 ... 85 °C / -25 ... 60 °C
Ingress Protection degree	IP 40 when plugged in
Housing material	Lexan
Weight	25 g

Standard types

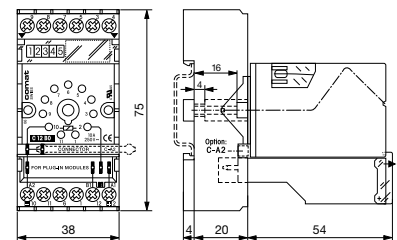
	Blue	Green
DC 24	CT524/DC24V R	CT524/DC24V

Remark: This module is part of several ready for connection units consisting of socket, relay and module.
A wide variety of suitable relays is available.

Connection diagram

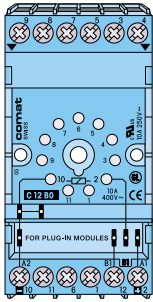


Dimensions [mm]



Technical approvals, conformities





DC Voltage Monitoring-Set
DC Current Monitoring-Set

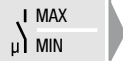
- Set-Delivery includes:
- Relay
 - Module
 - Front cover
 - Socket
 - Retaining clip



Monitoring Module

4 functions can be selected:
Overvoltage/undervoltage monitoring with adjustable hysteresis or 2 range monitors (INT or EXT). Adjustable alarm delay. LED display for errors and ok. Contact inspection window at the top. Manual safety operation.

Relay data's see:
Section Industrial Relays

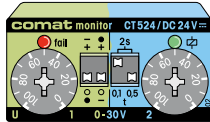


Alarm delay t	0,1/0,5/2s
Reset time tR	100ms
Voltage tolerance	0,8-1,2Un
Power consumption	≤0,5W
Ambient temperature	-25...+60°C

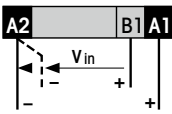
Data at Tamb. = 20°C

CT524
DC Voltage Monitoring

Range: 0-30V
Umax: 40V



Triggering



Input resistance
B1 → A2: 100kΩ

Set Order-Nr.:
CT524.3-A30/DC24V R

- Delivery includes:
- Relay C3-A30X/DC24V
 - Module CT524/DC24V R
 - Front cover FS-R
 - Socket C12B0 R
 - Retaining clip S3-C

Set Order-Nr.:
CT524.3-T31/DC24V R

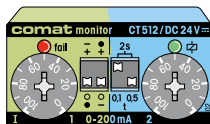
- Delivery includes:
- Relay C3-T31X/DC24V
 - Module CT524/DC24V R
 - Front cover FS-R
 - Socket C12B0 R
 - Retaining clip S3-C

Set Order-Nr.:
CT524.3-T32/DC24V R

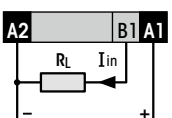
- Delivery includes:
- Relay C3-T32X/DC24V
 - Module CT524/DC24V R
 - Front cover FS-R
 - Socket C12B0 R
 - Retaining clip S3-C

CT512
DC Current Monitoring

Range: 0-200mA
Imax: 300mA



Triggering



Voltage drop
A1 → B1 ≤ 300mV

Set Order-Nr.:
CT512.3-A30/DC24V R

- Delivery includes:
- Relay C3-A30X/DC24V
 - Module CT512/DC24V R
 - Front cover FS-R
 - Socket C12B0 R
 - Retaining clip S3-C

Set Order-Nr.:
CT512.3-T31/DC24V R

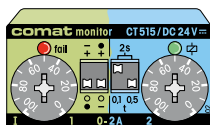
- Delivery includes:
- Relay C3-T31X/DC24V
 - Module CT512/DC24V R
 - Front cover FS-R
 - Socket C12B0 R
 - Retaining clip S3-C

Set Order-Nr.:
CT512.3-T32/DC24V R

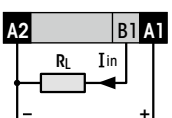
- Delivery includes:
- Relay C3-T32X/DC24V
 - Module CT512/DC24V R
 - Front cover FS-R
 - Socket C12B0 R
 - Retaining clip S3-C

CT515
DC Current Monitoring

Range: 0-2A
Imax: 3A



Triggering



Voltage drop
A1 → B1 ≤ 200mV

Set Order-Nr.:
CT515.3-A30/DC24V R

- Delivery includes:
- Relay C3-A30X/DC24V
 - Module CT515/DC24V R
 - Front cover FS-R
 - Socket C12B0 R
 - Retaining clip S3-C

Set Order-Nr.:
CT515.3-T31/DC24V R

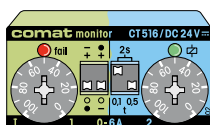
- Delivery includes:
- Relay C3-T31X/DC24V
 - Module CT515/DC24V R
 - Front cover FS-R
 - Socket C12B0 R
 - Retaining clip S3-C

Set Order-Nr.:
CT515.3-T32/DC24V R

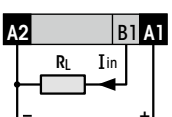
- Delivery includes:
- Relay C3-T32X/DC24V
 - Module CT515/DC24V R
 - Front cover FS-R
 - Socket C12B0 R
 - Retaining clip S3-C

CT516
DC Current Monitoring

Range: 0-6A
Imax: 7A



Triggering



Voltage drop
A1 → B1 ≤ 100mV

Set Order-Nr.:
CT516.3-A30/DC24V R

- Delivery includes:
- Relay C3-A30X/DC24V
 - Module CT516/DC24V R
 - Front cover FS-R
 - Socket C12B0 R
 - Retaining clip S3-C

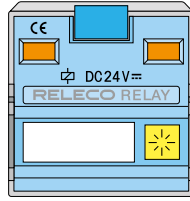
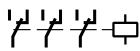
Set Order-Nr.:
CT516.3-T31/DC24V R

- Delivery includes:
- Relay C3-T31X/DC24V
 - Module CT516/DC24V R
 - Front cover FS-R
 - Socket C12B0 R
 - Retaining clip S3-C

Set Order-Nr.:
CT516.3-T32/DC24V R

- Delivery includes:
- Relay C3-T32X/DC24V
 - Module CT516/DC24V R
 - Front cover FS-R
 - Socket C12B0 R
 - Retaining clip S3-C

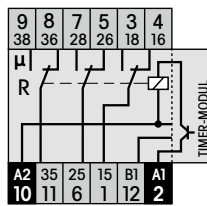
Power Relay



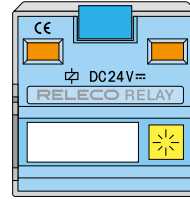
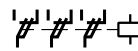
C3-A30X

Universal
Power Relay 10A.
With 3 power changeover-contacts this is the robust relay for AC and DC circuits ranging from 10mA 10V.

10A 250V~
10mA 10V



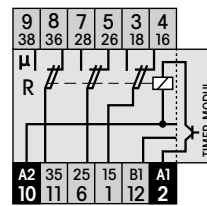
Control Relay



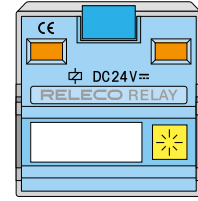
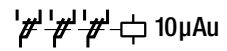
C3-T31X

Relay with 3 twin contacts 6A
The control relay with highest switching reliability for control and signal circuits ranging from 5mA 5V.

6A 250V~
5mA 5V



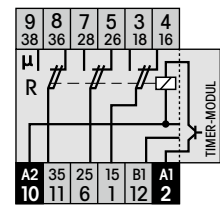
Signal Relay



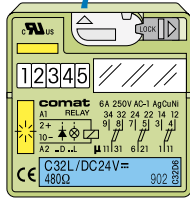
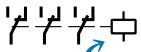
C3-T32X

Relay with 3 twin contacts, 10μ gold flush
The twin contact relay with highest switching reliability for signal circuits ranging from 1mA 5V. Recommend. upto 0,2A 30V.

6A 250V~
1mA 5V



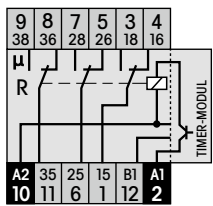
Power Relay



C31L

Universal Power Relay 10A
with 3 power changeover-contacts this is the robust relay for AC and DC circuits ranging from 50mA 10V.

10 A 250V~
50mA 10V



Set Order-Nr.:

CT524.31/DC24V

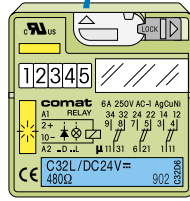
Delivery includes:

- Relay C31L/DC24V
- Module CT524/DC24V
- Front cover FS-C
- Socket C12B0
- Retaining clip HF-32

CT524.31R/...V

DC 24, 36V

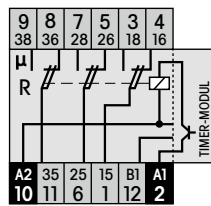
Control Relay



C32L

Relay with 3 twin contacts 6A
The control relay with highest switching reliability for control and signal circuits ranging from 10mA 5V.

6 A 250V~
10mA 5V



Set Order-Nr.:

CT524.32/DC24V

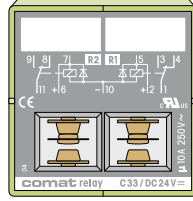
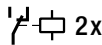
Delivery includes:

- Relay C32L/DC24V
- Module CT524/DC24V
- Front cover FS-C
- Socket C12B0
- Retaining clip HF-32

CT524.32R/...V

DC 24, 36V

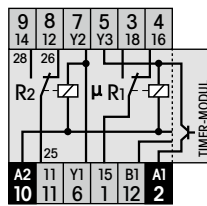
Power Relay



C33

Double-channel Power Relay 10A
With 2x1 power changeover-contacts this is a robust relay for AC and DC circuits ranging from 10mA 12V.

10 A 250V~
10mA 12V



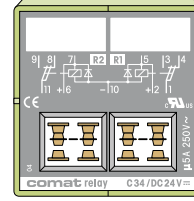
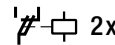
Set Order-Nr.:

CT524.33/DC24V

Delivery includes:

- Relay C33/DC24V
- Module CT524/DC24V
- Front cover FS-C
- Socket C12B0
- Retaining clip HF-32

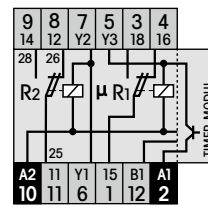
Control Relay



C34

Double-channel Control Relay 5A
With 2x1 changeover-contact. The control relay with increased switching reliability for control and signal circuits from 1mA 6V.

5 A 250V~
1mA 6V



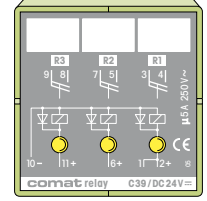
Set Order-Nr.:

CT524.34/DC24V

Delivery includes:

- Relay C34/DC24V
- Module CT524/DC24V
- Front cover FS-C
- Socket C12B0
- Retaining clip HF-32

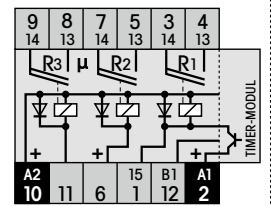
Power- and Signal Relay



C39

Triple-channel Twin Contact Relay 5A
with 3x1 NO contact. Ideal for interface applications ranging from 1mA 100mV. LED display for each channel.

5 A 250V~
1mA 100mV



Set Order-Nr.:

CT524.39/DC24V

Delivery includes:

- Relay C39/DC24V
- Module CT524/DC24V
- Front cover FS-C
- Socket C12B0
- Retaining clip HF-32

Set Order-Nr.:

CT512.31/DC24V

- Delivery includes:
- Relay C31L/DC24V
 - Module CT512/DC24V
 - Front cover FS-C
 - Socket C12B0
 - Retaining clip HF-32

CT512.31R/...V

DC 24, 36V

Set Order-Nr.:

CT512.32/DC24V

- Delivery includes:
- Relay C32L/DC24V
 - Module CT512/DC24V
 - Front cover FS-C
 - Socket C12B0
 - Retaining clip HF-32

CT512.32R/...V

DC 24, 36V

Set Order-Nr.:

CT512.33/DC24V

- Delivery includes:
- Relay C33/DC24V
 - Module CT512/DC24V
 - Front cover FS-C
 - Socket C12B0
 - Retaining clip HF-32

Set Order-Nr.:

CT512.34/DC24V

- Delivery includes:
- Relay C34/DC24V
 - Module CT512/DC24V
 - Front cover FS-C
 - Socket C12B0
 - Retaining clip HF-32

Set Order-Nr.:

CT512.39/DC24V

- Delivery includes:
- Relay C39/DC24V
 - Module CT512/DC24V
 - Front cover FS-C
 - Socket C12B0
 - Retaining clip HF-32

Set Order-Nr.:

CT515.31/DC24V

- Delivery includes:
- Relay C31L/24V
 - Module CT515/24V
 - Front cover FS-C
 - Socket C12B0
 - Retaining clip HF-32

CT515.31R/...V

DC 24, 36V

Set Order-Nr.:

CT515.32/DC24V

- Delivery includes:
- Relay C32L/24V
 - Module CT515/24V
 - Front cover FS-C
 - Socket C12B0
 - Retaining clip HF-32

CT515.32R/...V

DC 24, 36V

Set Order-Nr.:

CT515.33/DC24V

- Delivery includes:
- Relay C33/DC24V
 - Module CT515/DC24V
 - Front cover FS-C
 - Socket C12B0
 - Retaining clip HF-32

Set Order-Nr.:

CT515.34/DC24V

- Delivery includes:
- Relay C34/DC24V
 - Module CT515/DC24V
 - Front cover FS-C
 - Socket C12B0
 - Retaining clip HF-32

Set Order-Nr.:

CT515.39/DC24V

- Delivery includes:
- Relay C39/DC24V
 - Module CT515/DC24V
 - Front cover FS-C
 - Socket C12B0
 - Retaining clip HF-32

Set Order-Nr.:

CT516.31/DC24V

- Delivery includes:
- Relay C31L/DC24V
 - Module CT516/DC24V
 - Front cover FS-C
 - Socket C12B0
 - Retaining clip HF-32

CT516.31R/...V

DC 24, 36V

Set Order-Nr.:

CT516.32/DC24V

- Delivery includes:
- Relay C32L/DC24V
 - Module CT516/DC24V
 - Front cover FS-C
 - Socket C12B0
 - Retaining clip HF-32

CT516.32R/...V

DC 24, 36V

Set Order-Nr.:

CT516.33/DC24V

- Delivery includes:
- Relay C33/DC24V
 - Module CT516/DC24V
 - Front cover FS-C
 - Socket C12B0
 - Retaining clip HF-32

Set Order-Nr.:

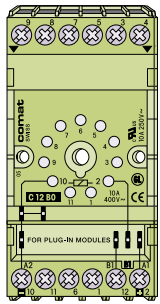
CT516.34/DC24V

- Delivery includes:
- Relay C34/DC24V
 - Module CT516/DC24V
 - Front cover FS-C
 - Socket C12B0
 - Retaining clip HF-32

Set Order-Nr.:

CT516.39/DC24V

- Delivery includes:
- Relay C39/DC24V
 - Module CT516/DC24V
 - Front cover FS-C
 - Socket C12B0
 - Retaining clip HF-32



DC Voltage Monitoring-Set
DC Current Monitoring-Set

- Set-Delivery includes:
- Relay
 - Module
 - Front cover
 - Socket
 - Retaining clip



Monitoring Module

4 functions can be selected:
Overvoltage/undervoltage monitoring with adjustable hysteresis or 2 range monitors (INT or EXT). Adjustable alarm delay. LED display for errors and ok. Contact inspection window at the top. Manual safety operation.

Relay data's see:
Section Industrial Relays

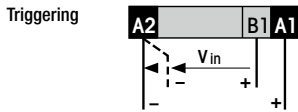
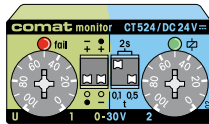


Alarm delay t	0,1/0,5/2s
Reset time tR	100ms
Voltage tolerance	0,8 -1,2Un
Power consumption	≤0,5W
Ambient temperature	-25...+60°C

Data at Tamb. = 20°C

CT524
DC Voltage Monitoring

Range: 0-30V
Umax: 40V



Set Order-Nr.:

CT524.35/DC24V

- Delivery includes:
- Relay C35/DC24V
 - Module CT524/DC24V
 - Front cover FS-C
 - Socket C12B0
 - Retaining clip HF-32

Set Order-Nr.:

CT524.36/DC24V

- Delivery includes:
- Relay C36/UC12-240V
 - Module CT524/DC24V
 - Front cover FS-C
 - Socket C12B0
 - Retaining clip HF-32

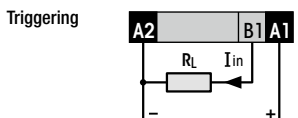
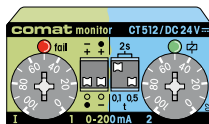
Set Order-Nr.:

CT524.37/DC24V

- Delivery includes:
- Relay C37/UC12-240V
 - Module CT524/DC24V
 - Front cover FS-C
 - Socket C12B0
 - Retaining clip HF-32

CT512
DC Current Monitoring

Range: 0-200mA
Imax: 300mA



Set Order-Nr.:

CT512.35/DC24V

- Delivery includes:
- Relay C35/DC24V
 - Module CT512/DC24V
 - Front cover FS-C
 - Socket C12B0
 - Retaining clip HF-32

Set Order-Nr.:

CT512.36/DC24V

- Delivery includes:
- Relay C36/UC12-240V
 - Module CT512/DC24V
 - Front cover FS-C
 - Socket C12B0
 - Retaining clip HF-32

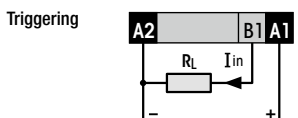
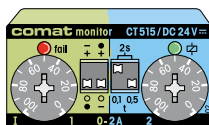
Set Order-Nr.:

CT512.37/DC24V

- Delivery includes:
- Relay C37/UC12-240V
 - Module CT512/DC24V
 - Front cover FS-C
 - Socket C12B0
 - Retaining clip HF-32

CT515
DC Current Monitoring

Range: 0-2A
Imax: 3A



Set Order-Nr.:

CT515.35/DC24V

- Delivery includes:
- Relay C35/DC24V
 - Module CT515/DC24V
 - Front cover FS-C
 - Socket C12B0
 - Retaining clip HF-32

Set Order-Nr.:

CT515.36/DC24V

- Delivery includes:
- Relay C36/UC12-240V
 - Module CT515/DC24V
 - Front cover FS-C
 - Socket C12B0
 - Retaining clip HF-32

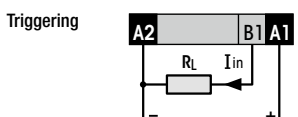
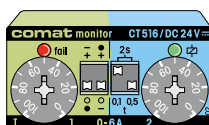
Set Order-Nr.:

CT515.37/DC24V

- Delivery includes:
- Relay C37/UC12-240V
 - Module CT515/DC24V
 - Front cover FS-C
 - Socket C12B0
 - Retaining clip HF-32

CT516
DC Current Monitoring

Range: 0-6A
Imax: 7A



Set Order-Nr.:

CT516.35/DC24V

- Delivery includes:
- Relay C35/DC24V
 - Module CT516/DC24V
 - Front cover FS-C
 - Socket C12B0
 - Retaining clip HF-32

Set Order-Nr.:

CT516.36/DC24V

- Delivery includes:
- Relay C36/UC12-240V
 - Module CT516/DC24V
 - Front cover FS-C
 - Socket C12B0
 - Retaining clip HF-32

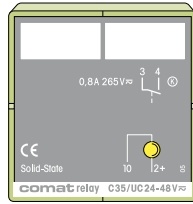
Set Order-Nr.:

CT516.37/DC24V

- Delivery includes:
- Relay C37/UC12-240V
 - Module CT516/DC24V
 - Front cover FS-C
 - Socket C12B0
 - Retaining clip HF-32

UC Solid-State Relay

1x



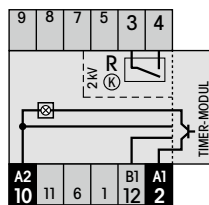
C35

Universal Solid-State Relay for AC or DC load

Highest switching frequency for virtually limitless life cycle due to solid-state operation. No external protective wiring required.

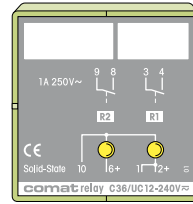
0,8A 10...265V~

1mA 10V



AC Solid-State Relay

2x



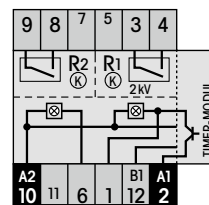
C36

AC SS double-channel

Triac output, crossover switch. Built-in RC wiring protection. Specially designed for frequent switching cycles and inductive loads. Minimum load: 30mA

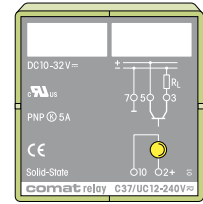
1A 20...265V~

30mA 20V



DC Solid-State Relay

1x



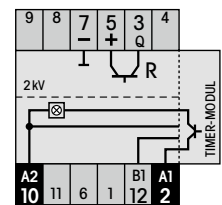
C37

DC SS single-channel

Bounce- and wearing- free for DC loads (inductive/capacitive). Short-circuit/overload proof. No external wiring protection required.

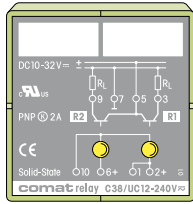
5A 10...32V=

1mA 10V



DC Solid-State Relay

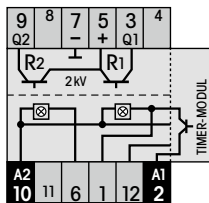
2x



C38

DC SS Relay double-channel
Bounce- and wearing- free for DC loads (inductive/capacitive). Short-circuit/overload proof. No external wiring protection required. 2A constant current per channel.

2A 10...32V=
1mA 10V



Set Order-Nr.:

CT524.38/DC24V

Delivery includes:

- Relay C38/UC12-240V
- Module CT524/DC24V
- Front cover FS-C
- Socket C12B0
- Retaining clip HF-32

Set Order-Nr.:

CT512. 38/DC24V

Delivery includes:

- Relay C38/UC12-240V
- Module CT512/DC24V
- Front cover FS-C
- Socket C12B0
- Retaining clip HF-32

Set Order-Nr.:

CT515.38/DC24V

Delivery includes:

- Relay C38/UC12-240V
- Module CT515/DC24V
- Front cover FS-C
- Socket C12B0
- Retaining clip HF-32

Set Order-Nr.:

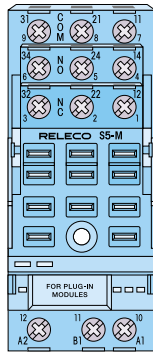
CT516.38/DC24V

Delivery includes:

- Relay C38/UC12-240V
- Module CT516/DC24V
- Front cover FS-C
- Socket C12B0
- Retaining clip HF-32



DC Voltage Monitoring-Set DC Current Monitoring-Set

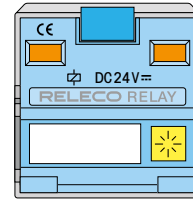


- Set-Delivery includes:
- Relay
 - Module
 - Front cover
 - Socket
 - Retaining clip



High Power Relay DC

16A 400V~

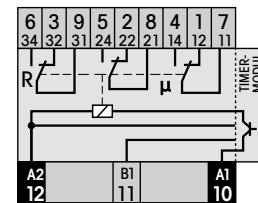


C5-A30X

Universal Power Relay 16A

With 3 power changeover-contacts this is the robust relay for AC and DC circuits ranging from 10mA 10V.

16A 400V~
10mA 10V



Set Order-Nr.:

CT524.5-A30/DC24V R

Delivery includes:

- Relay C5-A30/DC24V
- Module CT524/DC24V R
- Front cover FS-C5
- Socket S-5M
- Retaining clip S3-C

Set Order-Nr.:

CT512.5-A30/DC24V R

Delivery includes:

- Relay C5-A30/DC24V
- Module CT512/DC24V R
- Front cover FS-C5
- Socket S-5M
- Retaining clip S3-C

Set Order-Nr.:

CT515.5-A30/DC24V R

Delivery includes:

- Relay C5-A30/DC24V
- Module CT515/DC24V R
- Front cover FS-C5
- Socket S-5M
- Retaining clip S3-C

Set Order-Nr.:

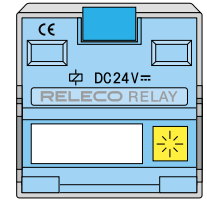
CT516.5-A30/DC24V R

Delivery includes:

- Relay C5-A30/DC24V
- Module CT516/DC24V R
- Front cover FS-C5
- Socket S-5M
- Retaining clip S3-C

High Power Relay DC

10A @ 220V=

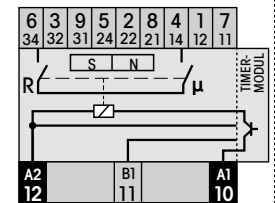


C5-M10X

Highpower Relay, in particular for DC loads upto 10A 220V= (DC1)

With 2 NO contacts in series and a blow magnet for safe arc extinguishing.

16A 400V~
10mA 10V



Set Order-Nr.:

CT524.5-M10/DC24V R

Delivery includes:

- Relay C5-M10/DC24V
- Module CT524/DC24V R
- Front cover FS-C5
- Socket S-5M
- Retaining clip S3-C

Set Order-Nr.:

CT512.5-M10/DC24V R

Delivery includes:

- Relay C5-M10/DC24V
- Module CT512/DC24V R
- Front cover FS-C5
- Socket S-5M
- Retaining clip S3-C

Set Order-Nr.:

CT515.5-M10/DC24V R

Delivery includes:

- Relay C5-M10/DC24V
- Module CT515/DC24V R
- Front cover FS-C5
- Socket S-5M
- Retaining clip S3-C

Set Order-Nr.:

CT516.5-M10/DC24V R

Delivery includes:

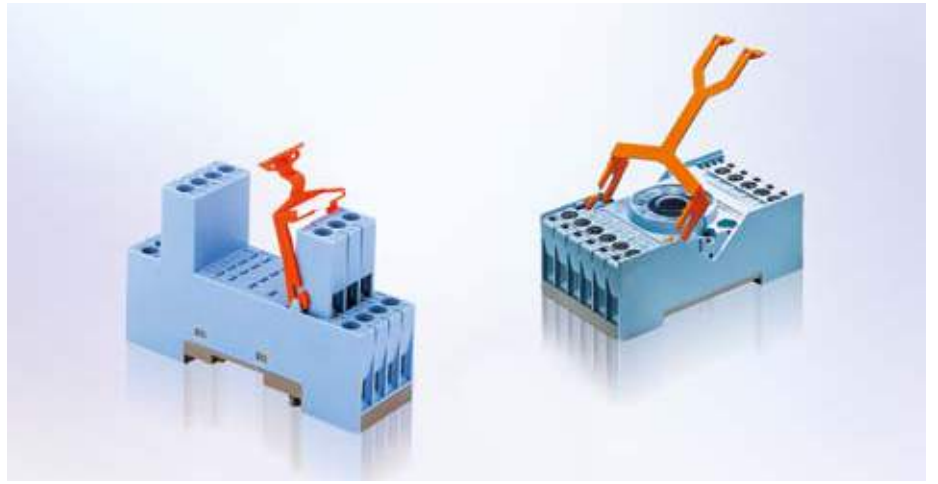
- Relay C5-M10/DC24V
- Module CT516/DC24V R
- Front cover FS-C5
- Socket S-5M
- Retaining clip S3-C

Notes



A large grid of graph paper for taking notes, consisting of 20 columns and 30 rows of small squares.

Sockets



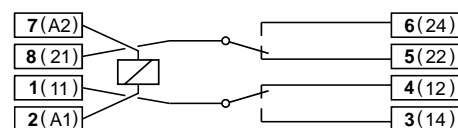
Type	S2-B 2-pole, 1 connection level Coding ring optional Integrated retaining clip and labelling space
Rated current	10 A
Specifications	
Rated load	10 A / 300 V
Insulation	Test voltage V rms / 1 min
– All terminals/DIN rail	2,5 kV
– Terminal/terminal	2,5 kV
Cross-section of connecting wire	
– Single-wire	4 mm ² or 2 x 2,5 mm ²
– Multi-wire	22 - 14 AWG
Max. screw torque	1,2 Nm
Screw dimensions	M3, Pozzi, slot
Integrated retaining clip/plastic	for relay series C2
Labelling space	detachable
Connection label	1...8; DIN/EN
Mounting	DIN rail T35 or mounting plate
Ambient temperature operation/storage	-40 (no ice)...60 °C / -40 ... 80 °C
Weight	48g



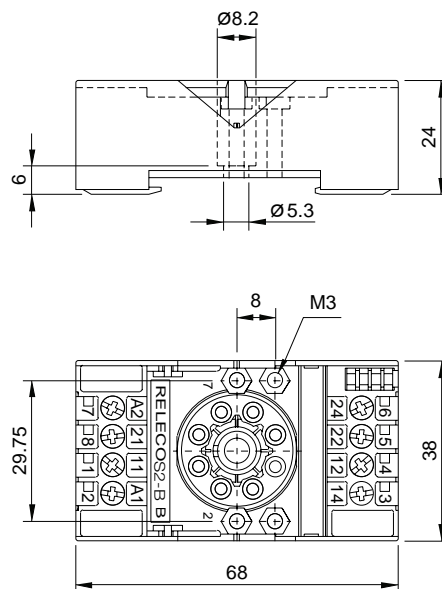
Associated, plug-in 8-pin MRC relays	C2-A, C2-G, C2-T
Suitable for holding the Releco coding ring For coding the relay and the socket.	

Accessories	
Coding ring, blue set:	S2-BC
Retaining spring, steel	Packaging unit: 5 pcs
Retaining clip, plastic	S3-C, S3-CT (with Timecube) CP-15B

Connection diagram



Dimensions [mm]



Technical approvals, conformities



EN 60947-1, EN 61810-1

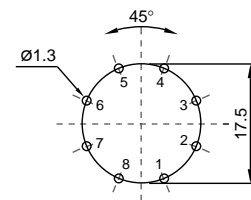
S2-L, S2-P, S2-PO

Socket for PCB and soldering according to IEC 67-I-5b for relays C2-...

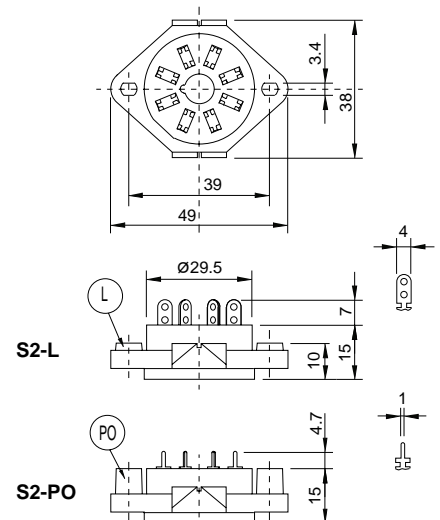
Type	S2-L 2-pole, flange panel mountable
	S2-P 2-pole, printed circuit
	S2-PO 2-pole, printed circuit with flange
Rated current	10 A
Specifications	
Rated load	10 A / 300 V
Insulation	test voltage V_{rms} / 1min
Between terminals	2,5 kV
Connection label	1...8; DIN/EN
Ambient temperature operation/storage	-40 (no ice)...60 °C / -40 ... 80 °C
Weight	17g
Accessories	
Retaining spring, steel	S3-C



Printed circuit lay-out [mm]



Dimensions [mm]



Technical approvals, conformities



EN 60947-1, EN 61810-1

Socket for 11-pin standard relay according to IEC 67-I-18b

Type	S3-B 3-pole, 1 connection level Coding ring optional Integrated retaining clip and labelling space
Rated current	10 A
Specifications	
Rated load	10 A / 250 V
Insulation	Test voltage V rms / 1 min
All terminals/DIN rail	2,5 kV
– Terminal/terminal	2,5 kV
Cross-section of connecting wire	
– Single-wire	4 mm ² or 2 x 2,5 mm ²
– Multi-wire	22 - 14 AWG
Max. screw torque	1,2 Nm
Screw dimensions	M3, Pozzi, slot
Integrated retaining clip/plastic	for relay series C3
Labelling space	detachable
Connection label	1... 11; DIN/EN
Mounting	DIN rail T35 or mounting plate
Ambient temperature	-40 (no ice)...60 °C / -40 ... 80 °C
Weight	55g

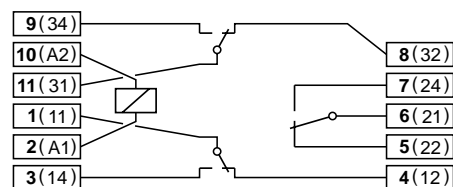
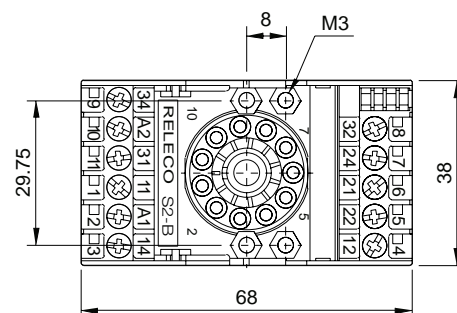
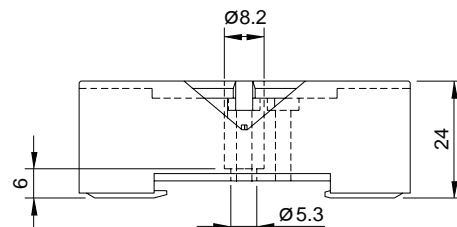
Associated, plug-in 11-pin MRC relays	C3-A, C3-G, C3-T, C3-X, C3-M, C3-R, C3-E, C3-N, C3-S
Suitable for holding the Releco coding ring For coding the relay and the socket.	

Accessories**Coding ring, blue set:**

Retaining spring, steel
Retaining clip, plastic

S3-BC

Packaging unit: 5 pcs
S3-C, S3-CT (with Timecube)
CP-15B

**Connection diagram****Dimensions [mm]****Technical approvals, conformities**

EN 60947-1, EN 61810-1

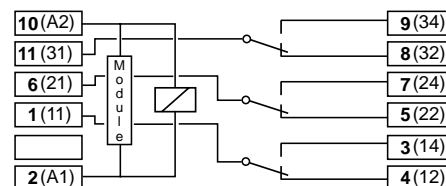
S3-MP

Socket for 11-pin standard relay according to IEC 67-I-18b

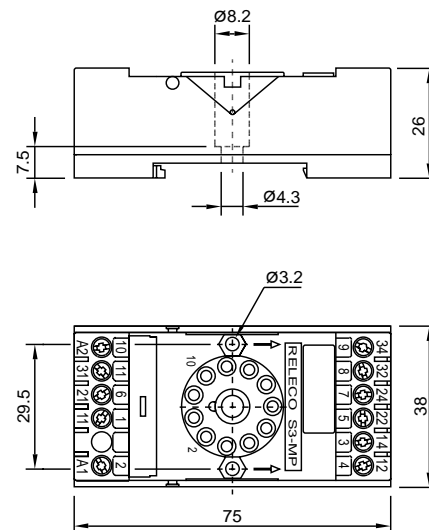
Type	S3-MP 3-pole, 1 connection level Integrated retaining clip and labelling space Accepts plug-in modules M3P in parallel with the coil
Rated current	10 A
Specifications	
Rated load	10 A / 250 V
Insulation	Test voltage V rms / 1 min
- All terminals/DIN rail	2,5 kV
- Terminal/terminal	2,5 kV
Cross-section of connecting wire	
- Single-wire	4 mm ² or 2 x 2,5 mm ²
- Multi-wire	22 - 14 AWG
Max. screw torque	1,2 Nm
Screw dimensions	M3, Pozi, slot
Integrated retaining clip/plastic	for relay series C3
Labelling space	detachable
Connection label	1...11; DIN/EN
Mounting	DIN rail T35 or mounting plate
Ambient temperature operation/storage	-40 (no ice)...60 °C / -40 ... 80 °C
Weight	54g
Associated, plug-in 11-pin MRC relays	C3-A, C3-G, C3-T, C3-X, C3-M, C3-R, C3-E, C3-N, C3-S
Suitable for holding the Releco coding ring For coding the relay and the socket.	



Connection diagram



Dimensions [mm]



Technical approvals, conformities



EN 60947-1, EN 61810-1

Socket for 11-pin standard relay according to IEC 67-I-18b

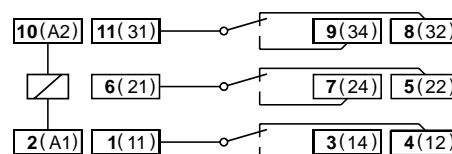
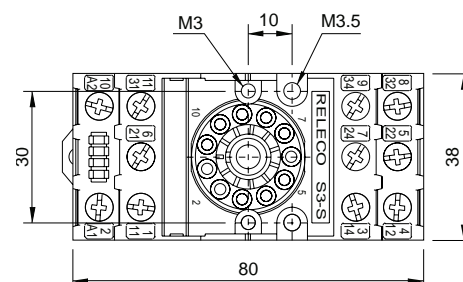
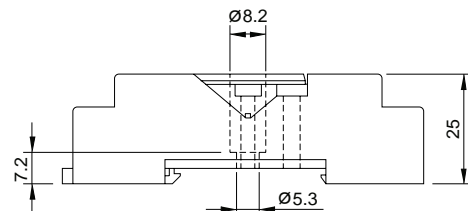
Type	S3-S 3-pole, 2 connection level Coding ring optional Integrated retaining clip and labelling space
Rated current	10 A
Specifications	
Rated load	10 A / 250 V
Insulation	Test voltage V rms / 1 min
– All terminals/DIN rail	2,5 kV
– Terminal/terminal	2,5 kV
Cross-section of connecting wire	
– Single-wire	4 mm ² or 2 x 2,5 mm ²
– Multi-wire	22 - 14 AWG
Max. screw torque	1,2 Nm
Screw dimensions	M3, Pozi, slot
Integrated retaining clip/plastic	for relay series C3
Labelling space	detachable
Connection label	1...11; DIN/EN
Mounting	DIN rail T35 or mounting plate
Ambient temperature operation/storage	-40 (no ice)...60 °C / -40 ... 80 °C
Weight	69g

Associated, plug-in 11-pin MRC relays	C3-A, C3-G, C3-T, C3-X, C3-M, C3-R, C3-E, C3-N, C3-S
Suitable for holding the Releco coding ring	
For coding the relay and the socket.	

DIN rail or panel mounting. Removable label.
EN /DIN and sequential numbering. According to EN 60947.1 and IEC 61810.1

Accessories

Coding ring, Set red:	S3-BC
Retaining spring, steel	Packaging unit: 5 pcs
Retaining clip, plastic	S3-C, S3-CT (with Timecube) CP-15B

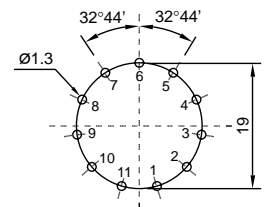
**Connection diagram****Dimensions [mm]****Technical approvals, conformities**

EN 60947-1, EN 61810-1

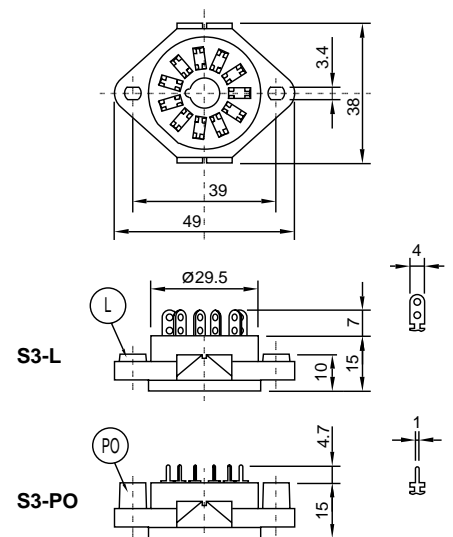
Type	S3-L 3-pole, flange panel mountable
	S3-PO 3-pole, printed circuit with flange
Rated current	10 A
Specifications	
Rated load	10 A / 250 V
Dielectric strength adjacent pin	2.5 kV
Weight	17g
Accessories	
Retaining spring, steel	S3-C



Printed circuit lay-out [mm]



Dimensions [mm]



Technical approvals, conformities



EN 60947-1, EN 61810-1

C12B0

Socket for 11 pin plug-in relays C3, C31, C32 and plug-in control modules



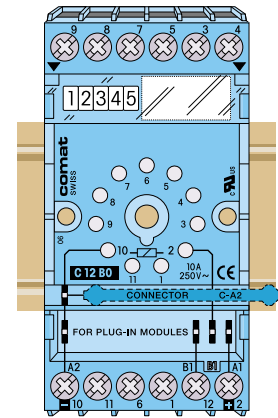
comat
RELECO
WORLD OF RELAYS

Type:	C12B0 R 3-pole, 1 level Module slot for timer- and monitoring modules, over voltage suppressing- and LED indicator modules coil bridge bus bar to connect in A2
Rated current	10 A
Specifications	Rated load 10 A / 400 V (cURus: 250 V) Insulation Test voltage V_{rms} / 1 min 2,5 kV - All terminals/DIN rail 2,5 kV - Terminal/terminal 2,5 kV Cross-section of connecting wire - Single-wire 1 x 6 mm ² , 2 x 1,5 mm ² - Multi-wire 1 x 4 mm ² /AWG12, 2 x 1,5 mm ² /AWG16 Max. screw torque 0,7 Nm Screw dimensions M3, Pozi, slot Labelling space detachable Connection label 1...12; DIN/EN Mounting DIN rail TS35 or panel mounting 1 x M4 Ambient temperature operation/storage -25 (no ice)...60 °C / -40 ... 80 °C Weight 61g

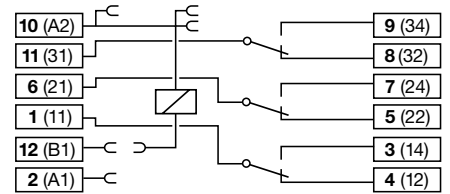
Associated plug-in 11-pin relays **C3, C31, C32**

Accessories	Retaining springs, steel Coil bridge bus bar Marking strip cardboard white 8 x 16	HF-32 (Relays C31, C32) S3-C (Relays C3) S3-CT (Timecube + Relays C3) HF-33 (Timecube + Relays C31, C32) C-A2 L-16/1 (under transp. plastic cover)
--------------------	---	---

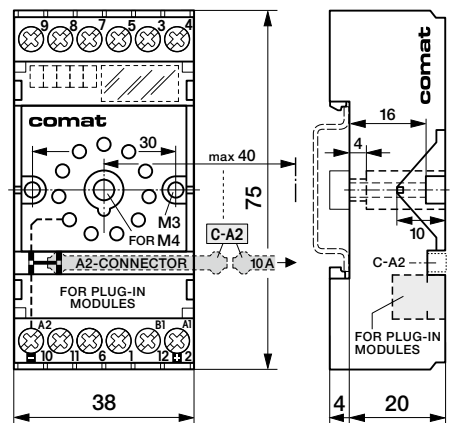
R-Modul	Module LED Module freewheeling diode Module freewheeling diode + LED Module RC-suppressor Module RC-suppressor + LED	RL1/UC 12-24 V RL1/AC 110-240 V RD1/DC 12-220 V RDL1/DC 12-24 V RDL1/DC 48 V RC1/UC 12-48 V RC1/UC 110-240 V RCL1/UC 24 V RCL1/UC 48 V RCL1/AC 110-240 V
----------------	--	---



Connection diagram



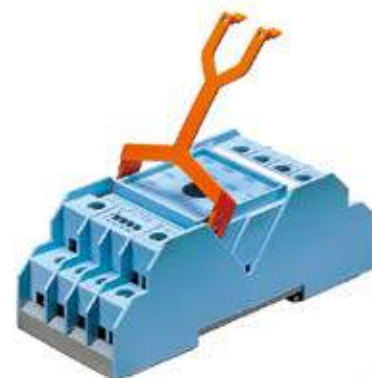
Dimensions [mm]



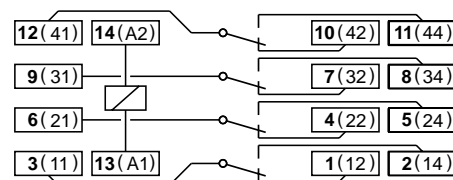
Technical approvals, conformities



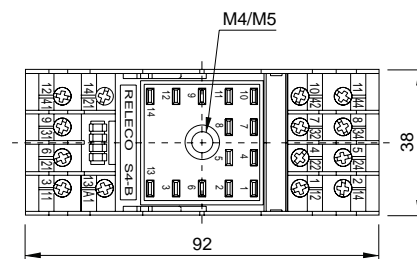
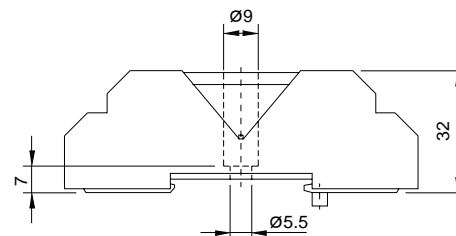
Type	S4-J 4-pole, 2 connection level Logic wiring Integrated retaining clip and labelling space
Rated current	10 A
Specifications	
Rated load	10 A / 250 V
Insulation	Test voltage V rms / 1 min
– All terminals/DIN rail	2,5 kV
– Terminal/terminal	2,5 kV
Cross-section of connecting wire	
– Single-wire	4 mm ² or 2 x 2,5 mm ²
– Multi-wire	22 - 14 AWG
Max. screw torque	1 Nm
Screw dimensions	M3,5, Philips-slot (combo)
Integrated retaining clip/plastic	for relay series C4
Labelling space	detachable
Connection label	1...14; DIN/EN
Mounting	DIN rail TS35 or mounting plate
Ambient temperature	-40 (no ice)...60 °C / -40 ... 80 °C
Weight	80g
Associated, plug-in 11-pin MRC relays	C4-A, C4-X, C4-R
Accessories	
Retaining spring, steel	S4-C
Retaining clip, plastic	CP-15B



Connection diagram



Dimensions [mm]



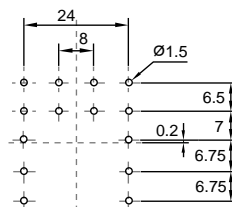
Technical approvals, conformities

CE Lloyd's RoHS
EN 60947, EN 61810

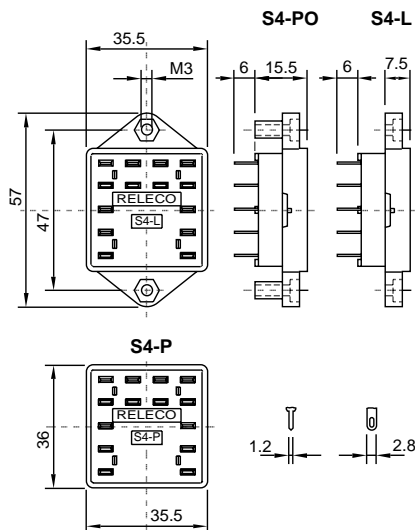
Type	S4-L 4-pole, flange panel mountable
	S4-P 4-pole, printed circuit
	S4-PO 4-pole, printed circuit with flange
Rated current	10 A
Specifications	
Rated load	10 A / 250 V
Test voltage benachbarte Pole	2.5 kV rms 1 min
Ambient temperature	-30 °C ... +60 °C
Weight	21g
Accessories	
Retaining spring, steel	S4-CL
Retaining clip, plastic	CP-15B



Printed circuit lay-out [mm]



Dimensions [mm]



Technical approvals, conformities

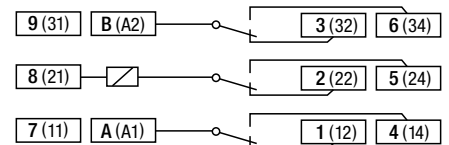
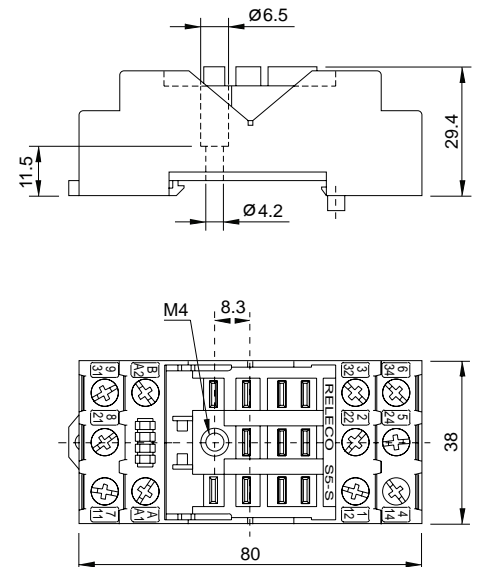


EN 60947-1, EN 61810-1

Type	S5-S 3-pole, 2 level Logic wiring Integrated retaining clip and labelling space
Rated current	16 A
Specifications	
Rated load	16 A / 400 V
Insulation	Test voltage V rms / 1 min
– All terminals/DIN rail	4 kV
– Terminal/terminal	4 kV
Cross-section of connecting wire	
– Single-wire	4 mm ² or 2 x 2,5 mm ²
– Multi-wire	22 - 14 AWG
Max. screw torque	1,2 Nm
Screw dimensions	M3,5, Pozi, slot
Integrated retaining clip/plastic	for relay series C5
Labelling space	detachable
Connection label	1...9, A, B; DIN/EN
Mounting	DIN rail TS35 or mounting plate
Ambient temperature operation/storage	-40 (no ice)...60 °C / -40 ... 80 °C
Weight	81g
Associated, plug-in 11-pin MRC relays	C5-A, C5-G, C5-X, C5-M, C5-R
Mounting in DIN rail TS35 or mounting plate. Labelling space. According to EN 60947 and IEC 61810	

Accessories

Retaining spring, steel	S4-C
Retaining clip, plastic	CP-15B

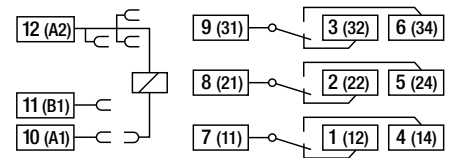
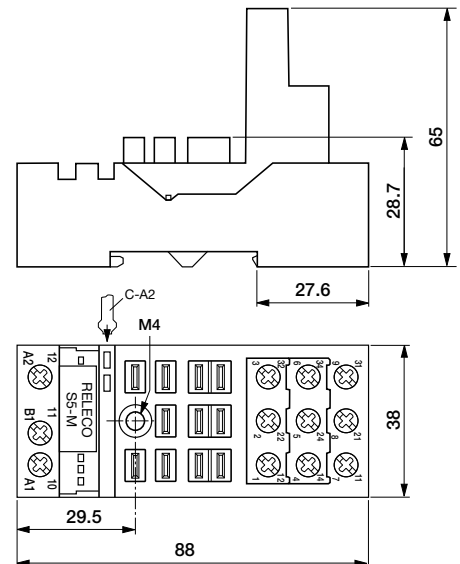
**Connection diagram****Dimensions [mm]****Technical approvals, conformities**

EN 60947-1, EN 61810-1

Type:	S5-M 3-pole, 3 level Module slot for timer- and monitoring modules, over voltage suppressing- and LED indicator modules coil bridge bus bar to connect in A2
Rated current	16 A
Specifications	
Rated load	16 A / 400 V
Insulation	Test voltage V_{rms} / 1 min
– All terminal/DIN rail	4 kV
– Terminal/terminal	4 kV
Cross section of connecting wire	
– Single wire	1 x 6 mm ² , 2 x 2,5 mm ²
– Multi wire	1 x 6 mm ² /AWG10, 2 x 1,5 mm ² /AWG16
Max. screw torque	1 Nm
Screw dimensions	M3,5, Pozi, slot
Integrated retaining clip/plastic	for relay series C5
Labelling space	detachable
Connection label	1 ... 12, DIN/EN
Mounting	DIN rail TS35 or panel mounting 1 x M4
Ambient temperature operation / storage	-40 (no ice) ... 60° C / -40 ... 80° C
Weight	92g
Associated, plug-in 11-pin MRC relays	C5-A, C5-G, C5-X, C5-M, C5-R

Accessories

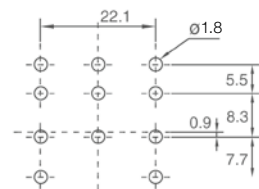
Coil bridge bus bar	C-A2
Retaining clip, plastic	S5MCP

**Connection diagram****Dimensions [mm]****Technical approvals, conformities**

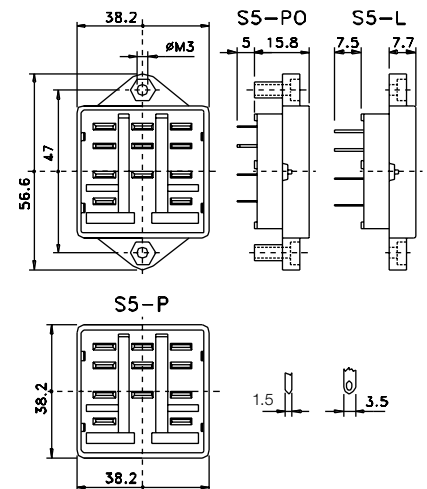
Type	<p>S5-L 3-pole, flange panel mountable</p> <p>S5-P 3-pole, printed circuit</p> <p>S5-PO 3-pole, printed circuit with flange</p>
Rated current	16 A
Specifications	
Rated load	16 A / 400 V (UL: 300 V)
Ambient temperature operation/storage	-40 (no ice)...60 °C / -40 ... 80 °C
Weight	20g
Accessories	
Retaining spring, steel	S4-L



Printed circuit lay-out [mm]



Dimensions [mm]



Technical approvals, conformities



EN 60947-1, EN 61810-1

S7-C

Socket for miniature relays C7-... and C80 series time relays

Type:	S7-C 2-pole, 1 level integrated clip and marking label suitable for clips C80 series time relays coil bridge bus bar to connect in A2 plug-in slot for overvoltage suppressing units
--------------	--

Rated current	10 A
----------------------	-------------

Specifications	
Rated load	10 A / 250 V
Insulation	Test voltage V_{rms} / 1 min
- All terminal/DIN rail	2.5 kV
- Terminal/terminal	2.5 kV
Cross section of connecting wire	
- Single wire	4 mm ² , 2 x 1,5 mm ²
- Multi wire	2,5 mm ² / AWG 16, 2 x 1 mm ² / AWG 18
Max. screw torque	0.7 Nm
Screw dimensions	M3, Pozi, slot
Integrated retaining clip/plastic	for relays C7
Labelling space	detachable
Connection label	1 ... 8, DIN/EN
Mounting	DIN rail TS35 or mounting plate
Ambient temperature operation/storage	-40 (no ice) ... 60 °C / -40 ... 80 °C
Weight	37g

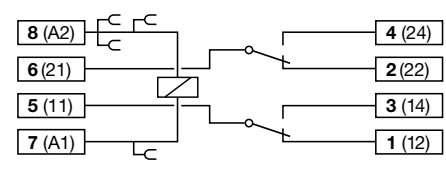
Associated plug-in 8-pin QRC relays	C7-A2x, C7-T, C7-G, C7-X, C7-W, C7-H
Associated C80 time relays	C83, C85, 84

Accessories	
Coil bridge bus bar	S7-B
Retaining clip, plastic	CP-09B

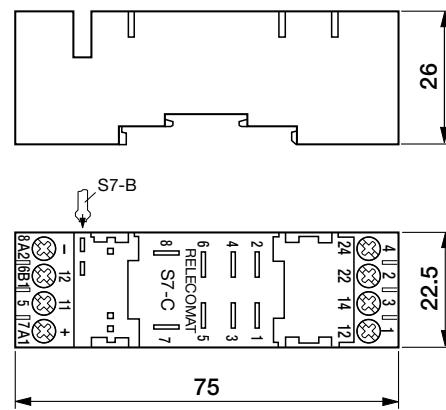
Please note:
This socket replaces former socket S7-M fully compatible



Connection diagram



Dimensions [mm]



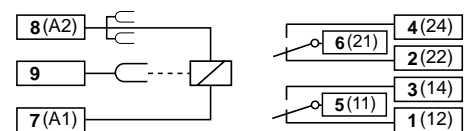
Technical approvals, conformities



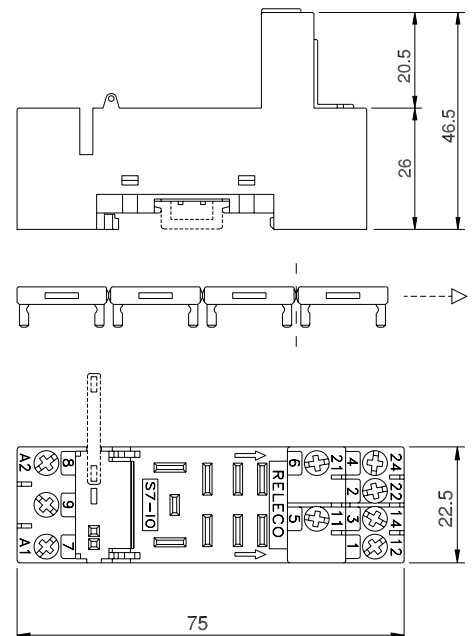
Type	S7-I/O 2-pole, 2 level Integrated clip and marking label Coil bridge bus bar to connect in A2 Logic wiring
Rated current	10 A
Specifications	
Rated load	10 A / 250 V
Insulation	Test voltage V rms / 1 min
- All terminals/DIN rail	2,5 kV
- Terminal/terminal	2,5 kV
Cross-section of connecting wire	
- Single-wire	4 mm ² or 2 x 2,5 mm ²
- Multi-wire	22 - 14 AWG
Max. screw torque	1,2 Nm
Screw dimensions	M3, Pozi, slot
Integrated retaining clip/plastic	for relay series C7
Labelling space	detachable
Connection label	1...8; DIN/EN
Mounting	DIN rail TS35 or mounting plate
Ambient temperature operation/storage	-40 (no ice)...60 °C / -40 ... 80 °C
Weight	38g
Associated, plug-in 8-pin QRC relays	C7-A2x, C7-T, C7-G, C7-X, C7-W, C7-H
Accessories	
Coil bridge bus bar	S7-B
Retaining clip, plastic	CP-01B



Connection diagram



Dimensions [mm]



Technical approvals, conformities

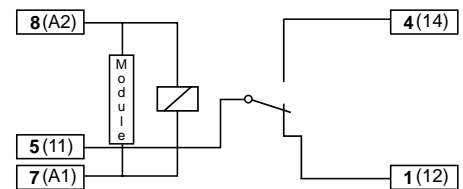


EN 60947-1, EN 61810-1

Type	S7-16 1-pole, 1 level Integrated retaining clip and labelling space
Rated current	16 A
Specifications	<p>Rated load 16 A / 250 V</p> <p>Insulation Test voltage V rms / 1 min – All terminals/DIN rail 2,5 kV – Terminal/terminal 2,5 kV</p> <p>Cross-section of connecting wire – Single-wire 4 mm² or 2 x 2,5 mm² – Multi-wire 22 - 14 AWG</p> <p>Max. screw torque 1,2 Nm</p> <p>Screw dimensions M3, Pozi, slot</p> <p>Integrated retaining clip/plastic for relay series C7-A10</p> <p>Labelling space detachable</p> <p>Connection label 1...8; DIN/EN</p> <p>Mounting DIN rail TS35 or mounting plate</p> <p>Ambient temperature operation/storage -40 (no ice)...60 °C / -40 ... 80 °C</p> <p>Weight 31g</p>
Associated, plug-in 5-pin QRC relays	C7-A10
Accessories	CP-07B Retaining clip, plastic

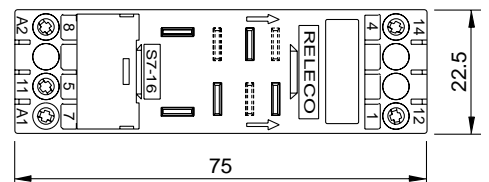
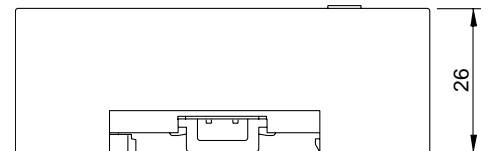


Connection diagram



Dimensions [mm]

S7-16 for relays C7-A10 (16 A)



Technical approvals, conformities



EN 60947-1, EN 61810-1

Type	S7-L 2-pole, flange panel mountable
	S7-P 2-pole, printed circuit
	S7-PO 2-pole, printed circuit with flange

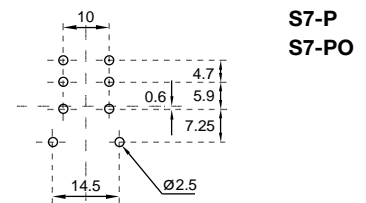
Rated current	10 A
----------------------	-------------

Specifications	
Rated load	10 A / 250 V
Dielectric strength adjacent pin	2.5 kV rms / 1 min
Connection label	1...8; DIN/EN
Integrated retaining clip/plastic	for relay series C7 S7-P: (CP-07B) S7-L + S7-PO: (CP-01B)
Ambient temperature operation/storage	-40 (no ice)....60 °C /-40 ... 80 °C
Weight	10g

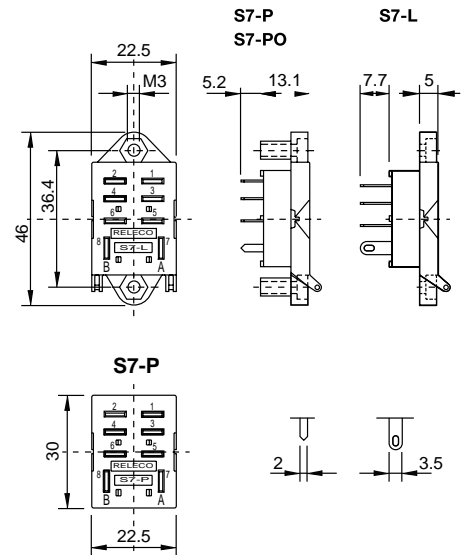
Accessories	
Retaining clip, plastic for S7-P	CP-07B
Retaining clip, plastic for S7-L + S7-PO	CP-01B



Printed circuit lay-out [mm]



Dimensions [mm]



Technical approvals, conformities

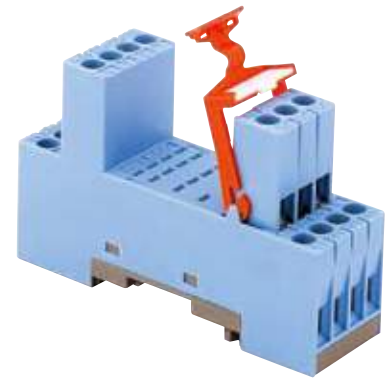


EN 60947-1, EN 61810-1

S9-M

Socket for miniature 4 pole relay C9-...

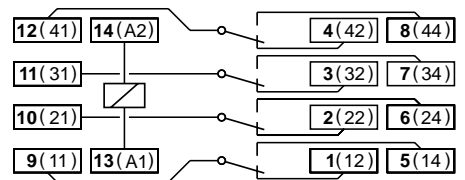
Type	S9-M 4-pole, 2 level Integrated clip and marking label
Rated current	6 A
Specifications	
Rated load	6 A / 250 V
Insulation	Test voltage V rms / 1 min
- All terminals/DIN rail	2,5 kV
- Terminal/terminal	2,5 kV
Cross-section of connecting wire	
- Single-wire	4 mm ² or 2 x 2,5 mm ²
- Multi-wire	22 - 14 AWG
Max. screw torque	0.7 Nm
Screw dimensions	M3, Pozi, slot
Integrated retaining clip/plastic	for relay series C9 (CP-01B)
Labelling space	detachable
Connection label	1...14; DIN/EN
Mounting	DIN rail TS35 or mounting plate
Ambient temperature operation/storage	-40 (no ice)...60 °C / -40 ... 80 °C
Weight	54g



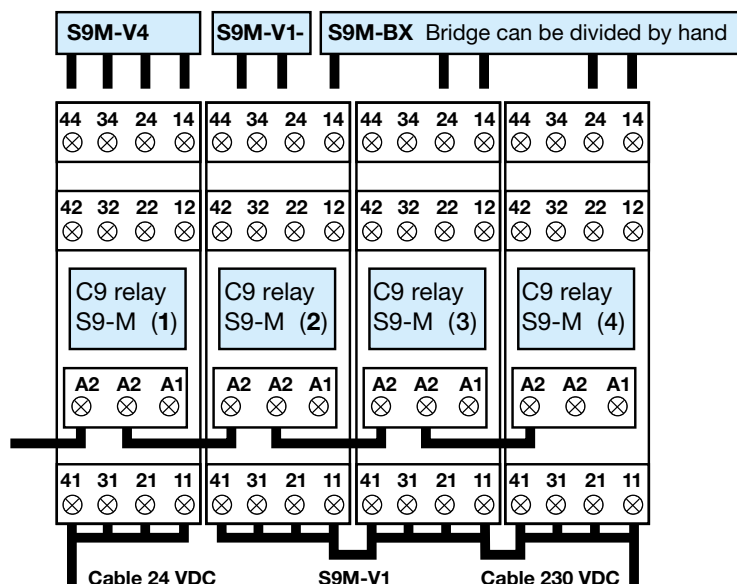
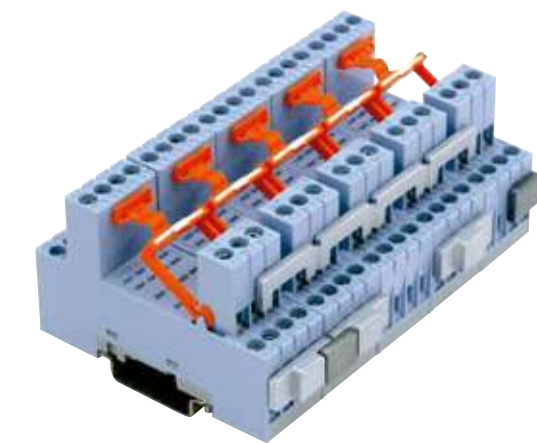
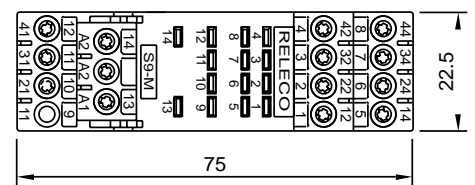
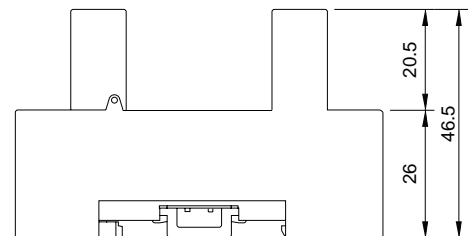
Socket for 4 poles, QRC relays	C9-A, C9-E, C9-R
---------------------------------------	-------------------------

Accessories	CP-01B
Retaining clip, plastic	

Connection diagram



Dimensions [mm]



Technical approvals, conformities



EN 60947-1, EN 61810-1

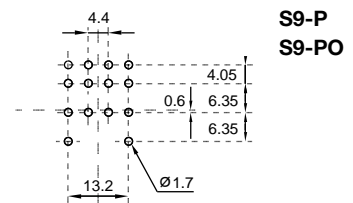
Type	S9-L 4-pole, flange panel mountable
	S9-P 4-pole, printed circuit
	S9-PO 4-pole, printed circuit with flange
Rated current	6 A

Specifications	
Rated load	6 A / 250 V
Dielectric strength adjacent pin	2.5 kV rms / 1 min
Connection label	1...14; DIN/EN
Integrated retaining clip/plastic	for relay series C9
Ambient temperature operation/storage	S9-P: (CP-07B) S9-L + S9-PO: (CP-01B) -40 (no ice)...60 °C / -40 ... 80 °C
Weight	12g

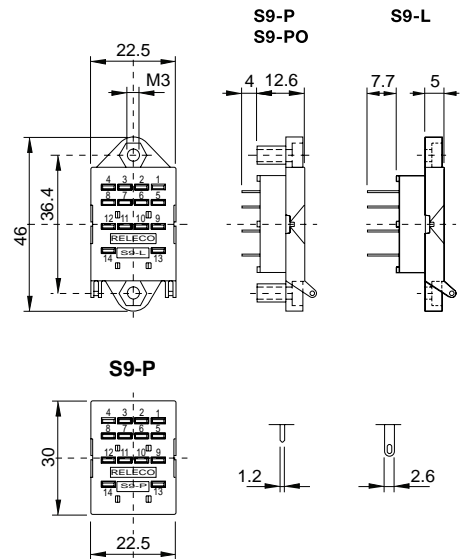
Accessories	
Retaining clip, plastic for S9-P	CP-07B
Retaining clip, plastic for S9-L + S9-PO	CP-01B



Printed circuit lay-out [mm]



Dimensions [mm]

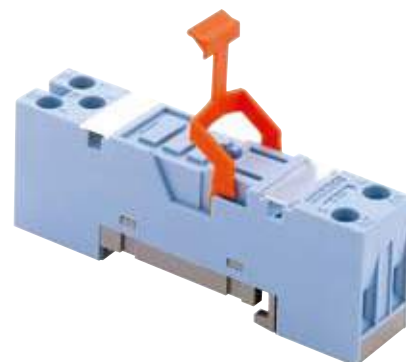


Technical approvals, conformities



EN 60947-1, EN 61810-1

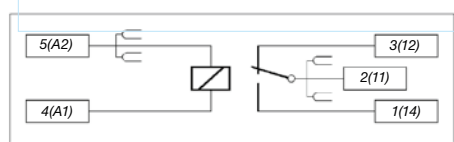
Type	<p>S10</p> <p>1-pole, 1 connection level</p> <p>Logic wiring</p> <p>Integrated retaining clip and labelling space</p> <p>Coil bridge bar for A2, 11</p>
Rated current	10 A
Specifications	<p>Rated load 10 A / 250 V</p> <p>Insulation Test voltage V rms / 1 min 5 kV</p> <p>– All terminals/DIN rail 5 kV</p> <p>Contact terminals 2,5 kV</p> <p>Contact / Coil terminals 5 kV</p> <p>Cross-section of connecting wire</p> <p>– Single-wire 4 mm² or 2 x 2,5 mm²</p> <p>– Multi-wire 22 - 14 AWG</p> <p>Max. screw torque 1,2 Nm</p> <p>Screw dimensions M3, Pozi, slot</p> <p>Integrated retaining clip/plastic for relay series C10, CSS (CP-17B)</p> <p>Labelling space detachable</p> <p>Connection label 1...5; DIN/EN</p> <p>Mounting DIN rail TS35 or mounting plate</p> <p>Ambient temperature operation/storage -40 (no ice)...60 °C / -40 ... 80 °C</p> <p>Weight 23g</p>



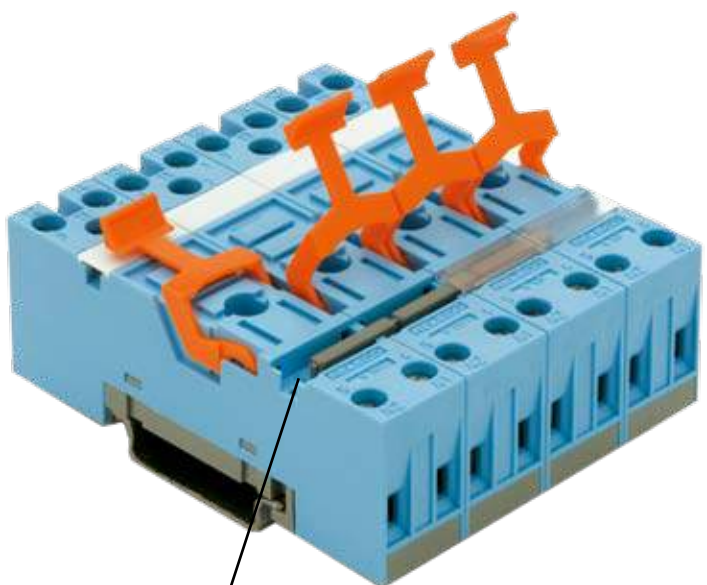
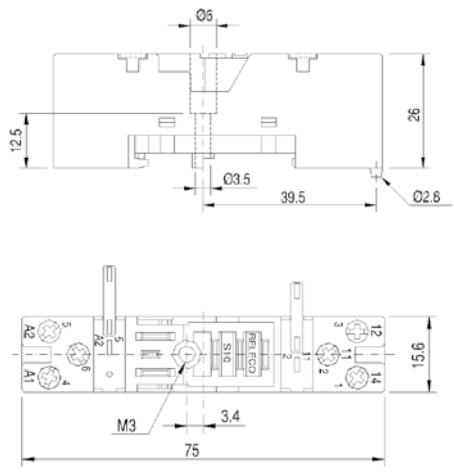
Socket for plug-in 10A IRC relays	C10-A, C10-T, CSS, C10-G
--	---------------------------------

Accessories	S10-BB
Coil bridge bars	CP-17B
Retaining clip, plastic	

Connection diagram



Dimensions [mm]



BRIDGE BAR

Technical approvals, conformities



EN 60947-1, EN 61810-1

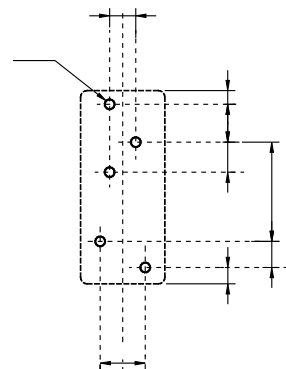
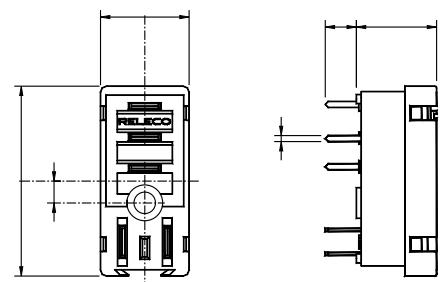
S10-P

Printed circuit socket for Interface relays, C10 and CSS

Type:	S10-P Printed circuit socket for 1-pole IRC relay
Rated current	10 A
Specifications	
Rated load	10 A / 250 V
Insulation	Test voltage V rms / 1 min
Coil terminals to contacts	5 kV rms
Hard Brass tin-platted terminals	0,5 x 1 mm
Integrated retaining clip/plastic	for relay series C10, CSS (CP-24B)
Labelling space	detachable
Connection label	1...5; DIN/EN
Ambient temperature operation/storage	-40 (no ice)...60 °C / -40 ... 80 °C
Weight	7g
Accessories	
Retaining clip, plastic	CP-24B



Dimensions [mm]



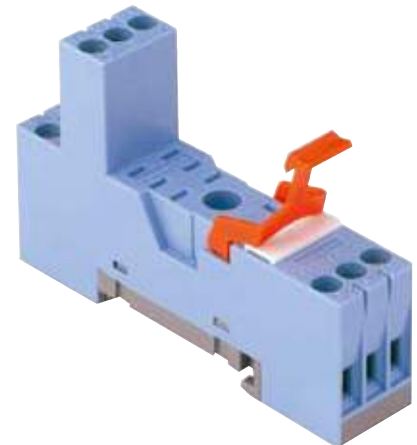
Technical approvals, conformities



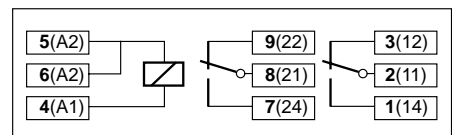
IEC 61810 EN 60947

Type	S12 I/O socket for C12 relays with 2 x CO Logic connection , 5 A
Rated current	5 A
Specifications	
Rated load	5 A / 250 V
Insulation	Test voltage V rms / 1 min
– All terminals/DIN rail	5 kV
Contacts terminals	2,5 kV
Contacts / Coil terminals	5 kV
Cross-section of connecting wire	
– Single-wire	4 mm ² or 2 x 2,5 mm ²
– Multi-wire	22 - 14 AWG
Max. screw torque	1,2 Nm
Screw dimensions	M3, Pozi, slot
Integrated retaining clip/plastic	for relay series C12 (CP-17B)
Labelling space	detachable
Connection label	1...9; DIN/EN
Mounting	DIN rail TS35 or mounting plate
Ambient temperature operation/storage	-40 (no ice)...60 °C / -40 ... 80 °C
Weight	31g

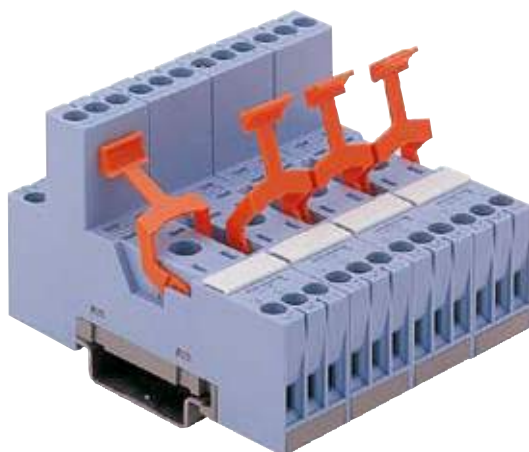
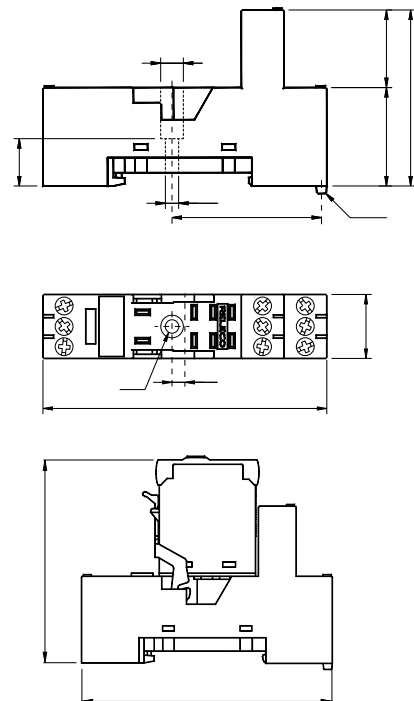
Socket for IRC relays	C12, C12G
Accessories	
Coil bridge bars	V10-G, V40-G, V10-R, V40-R, V10-A, V40-A
Retaining clip, plastic	B20-G, B20-R, B20-A, CP-07B CP-17B



Connection diagram



Dimensions [mm]



Technical approvals, conformities



IEC 61810 EN 60947

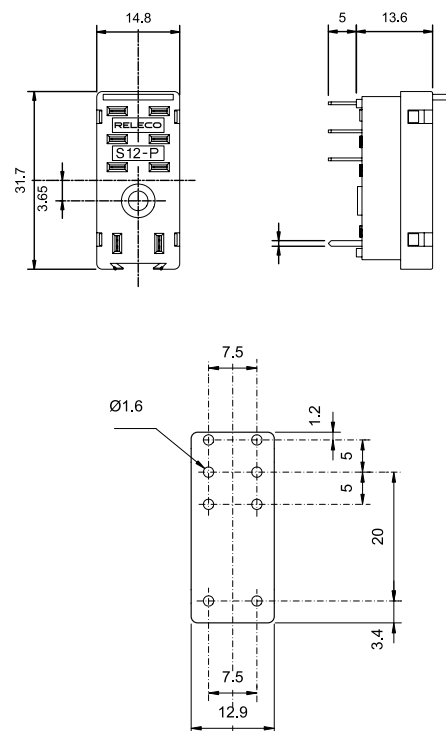
S12-P

Printed circuit socket for Interface relays, C12

Type:	S12-P Printed circuit socket for 2-pole C12 relay
Rated current	5 A
Specifications	
Rated load	5 A / 250 V
Insulation	Test voltage V rms / 1 min
– Pole / Pole	3 kV
– Coil / contact terminals	5 kV
Hard brass tin-plated terminals	0,5 x 1 mm
Weight	7g
Integrated retaining clip/plastic	for relay series C12, (CP-24B)
Accessories	
Retaining clip, plastic	CP-24B



Dimensions [mm]



Technical approvals, conformities



IEC 61810 EN 60947

Notes

Grid area for notes

Worldwide Sales Net

ARGENTINA



WINTERS INSTRUMENTS S.A.
B1640BIN Martinez - Buenos Aires
www.winters.com.ar

AUSTRALIA



ARLIN PTY. LTD.
Thomastown Vic 3074
www.arlin.com.au

AUSTRIA



AVS SCHMERSAL VERTRIEBS GMBH
1230 Wien
www.avs-schmersal.at

BELGIUM



MULTIPROX N.V.
9300 Aalst
www.multiprox.be

BRAZIL



COMAT RELECO LTDA
09550-190 Sao Caetano/Sao Paulo
www.comatreleco.com.br

CANADA



CHARTWELL AUTOMATION INC.
Markham, Ontario L6G 1B5
www.chartwell.ca

CHILE



ELECTRÓNICA RHOMBERG LTD.
Santiago de Chile
www.rhomberg.cl

CHINA



ELCO ELECTRONICS CO. LTD.
Tianjin 300385
www.elco-holding.com

COLOMBIA



ACJ HIGH VOLTAGE LTD.
Bogota D.C. Colombia
www.acj.com.co

CZECH REPUBLIC



EIG-OEM AUTOMATIC SPOL. S.R.O.
140 00 Praha 4
www.oem-automatic.cz

DENMARK



OEM AUTOMATIC A/S
4040 Jyllinge
www.oemautomatic.dk

ESTONIA



OEM EESTI OÜ
1137 Tallinn
www.oem.fi

ECUADOR



IANDCECONTROL S.A. (I & C)
Quito
www.iandcecontrol.com

FRANCE



RELECOMAT FRANCE SARL
83520 Roguebrune - Sur - Argens
www.relecomat.fr

FINLAND



OEM AUTOMATIC OY
20750 Turku
www.oem.fi

GERMANY



COMAT RELECO GMBH
21465 Reinbek
www.comatreleco.de

GREECE



KALAMARAKIS SAPOUNAS AUTOMATION SA.
13671 Acharnes - Athens
www.ksa.gr

INDIA



PARAMOUNT INDUSTRIES
Bangalore 560 010
www.paramount.net.in

IRAN



SEYED GHASEM RIAZI TRADING
15949 Teheran
www.sgrtrading.com

IRELAND



TCM CONTROLS LTD.
Dublin 12
www.tcmcontrols.com

ITALY



SOFTING ITALIA SRL.
20090 Cesano Boscone
www.softingitalia.it

KOREA



MEC MAHANI ELECTRIC CO. LTD.
135-080 Seoul
www.mec.co.kr

LITHUANIA



HIDROTEKA ENGINEERING SERVICES
51333 Kaunas
www.hidroteka.lt

LITHUANIA



ELINTA UAB.
54469 Kauno raj.
www.elintosprekyba.lt

MAROCCO



MAGHREB ELECTRO-TECHNIQUE SARL.
Casablanca 20250
www.beltransfo.com

MEXICO



TURCK MEXICO S. DE R.L. DE C.V.
Saltillo Coahuila 25315
www.turck.com.mx

NETHERLANDS



VIERPOOL BV.
3606 AS Maarssen
www.vierpool.nl

NEW ZEALAND



CUTHBERT STEWART LTD
Wellington
www.cuthbertstewart.co.nz

NORWAY



OEM AUTOMATIC AS
3003 Drammen
www.oem.no

PAKISTAN



GINZA INTERNATIONAL CORPORATION
Karachi - 74000
Ginza-int@cyber.net.pk

PERU



PROMOTORES ELÉCTRICOS S.A.
Lima 13 - La Victoria
www.promelsa.com.pe

POLAND



OEM AUTOMATIC SP. Z.O.O.
02-676 Warszawa
www.oemautomatic.com.pl

ROMANIA



SYSCOM 18 S.R.L.
71255 Bucharest
www.syscom.ro

RUSSIA



SENSORLINK LLC.
125080 Moscow
www.sensorlink.ru

RUSSIA



POLIGON JSC.
197376 St. Petersburg
www.poligon.info

SINGAPORE



FUTRON ELECTRONICS PTE. LTD.
Singapore 318995
www.futronelectronics.com.sg

SWEDEN



OEM INTERNATIONAL AB
573 28 Tranas
www.oem.se

SWITZERLAND



COMAT AG
3076 Worb
www.comat.ch

TAIWAN



E-SENSORS & AUTOMATION CORP.
Kaohsiung, Taiwan
www.e-sensors.com.tw

TURKEY



CERAN OTOMASYON LTD.
34384 Okmeydani/Istanbul
www.ceran.com.tr

THAILAND



ZIGMAACT CO. LTD.
Bangkok 10700
www.zigmaact.com

UNITED KINGDOM



OEM AUTOMATIC LTD.
Leicester LE8 6ZG
www.oem.co.uk

URUGUAY



ELEKTROSWEDEN S.A.
11100 Montevideo
www.elektrosweden.com.uy

USA



TURCK INC.
Plymouth MN 55441
www.turck-usa.com



Headquarters & Sales

Comat AG
Bernstrasse 4
3076 Worb, Switzerland
Phone: +41 (0)31 838 55 77
Fax: +41 (0)31 838 55 99
E-Mail: info@comat.ch
Web: www.comat.ch